

Software Manual

TMflow



Original Instruction

This Manual contains information of the Techman Robot product series (hereinafter referred to as the TM Robot). The information contained herein is the property of Techman Robot Inc. (hereinafter referred to as the Corporation). No part of this publication may be reproduced or copied in any way, shape or form without prior authorization from the Corporation. No information contained herein shall be considered an offer or commitment. It may be subject to change without notice. This Manual will be reviewed periodically. The Corporation will not be liable for any error or omission.

TM logo is registered trademark of TECHMAN ROBOT INC. in Taiwan and other countries and the company reserves the ownership of this manual and its copy and its copyrights.

Revision History Table	20
1. General	21
1.1 Overview.....	21
1.2 Warning and Caution Symbols	21
1.3 Safety Precautions	22
1.4 Validation and Responsibility	23
1.5 Limitation of Liability	23
1.6 Functional Note Symbol	23
2. Start up and Activation.....	24
2.1 Overview.....	24
2.2 Start Up	24
2.2.1 Plug in the Power	24
2.2.2 Start up from Packing Pose	24
2.2.3 Standard Start Up	28
2.2.4 TM Robot HMI TMflow Operation	29
2.2.4.1 Local Operation Method	29
2.2.4.2 Wireless Access Point Connection Method	30
2.2.4.3 Wired Network Connection Method.....	31
3. Safety Settings.....	33
3.1 Overview.....	33
3.2 Safety Permission Settings.....	33
3.3 Safety Setting	33
3.3.1 Performance Safety Settings	34
3.3.2 Human – Machine Safety Settings.....	35
3.3.3 Safety IO Settings	38
3.3.3.1 Resume Setting of User Connected External Safeguard Input Port	39
3.3.3.2 Resume Setting of User Connected External Safeguard Input Port for Human - Machine Safety Settings	39
3.3.3.3 Safeguard Port Setting for the Hardware Version prior to 2.00 (inclusive).....	40
3.3.3.4 Enabling Device Setting (HW 3.2 or newer exclusive)	40
3.3.4 Cartesian Limit A & B	41
3.3.5 Project Speed Adjustment Setting	41
3.3.6 Switch between Modes	42
4. Start Your First Project.....	44
4.1 Overview.....	44

4.2 Initial Setting.....	44
4.3 M/A Mode and FreeBot.....	44
4.4 Build and Run Your First Project.....	46
4.5 Shutdown.....	49
5. Operation Interface.....	51
5.1 Overview.....	51
5.2 Login/Logout.....	51
5.3 Connection	52
5.3.1 Local Connection	52
5.3.2 Remote Connection	52
5.4 View.....	53
5.4.1 Display Board.....	53
5.4.2 Flow	54
5.4.3 IO	55
5.4.4 Simulator.....	55
5.4.5 Status.....	56
5.4.6 Vision Viewer	56
5.5 Run Setting.....	57
5.6 Project	58
5.6.1 Project Editing Toolbar	59
5.6.1.1 Create New Project	59
5.6.1.2 Save Project	60
5.6.1.3 Open Project	60
5.6.1.4 Step Run	61
5.6.1.5 Point Manager	62
5.6.1.6 Base Manager	64
5.6.1.7 Controller.....	65
5.6.1.8 Variables.....	68
5.6.1.9 EditBlock	69
5.6.1.10 Current Base and Base List	69
5.6.1.11 Current TCP and TCP List.....	70
5.6.1.12 Display Manager	70
5.6.2 Node Menu and Flow Editing Area	71
5.6.3 Project Function Menu	73
5.6.3.1 Search Function	73
5.6.3.2 Operation Space	74

5.6.3.3 Modbus Device.....	74
5.6.3.4 Set IO while Project Error.....	74
5.6.3.5 Set IO while Project Stop	74
5.6.3.6 Stop Watch	74
5.6.3.7 View.....	75
5.6.3.8 F/T Sensor.....	76
5.6.3.9 Serial Port.....	76
5.6.3.10 Path Generate	77
5.6.3.11 Joint Loading	78
5.7 Robot Setting.....	78
5.7.1 Wizard.....	79
5.7.2 Vision Setting	79
5.7.3 TCP	79
5.7.4 IO Setup.....	79
5.7.5 Safety.....	80
5.7.6 Controller	80
5.7.7 Speech.....	80
5.7.8 End Button	81
5.7.9 Component	82
5.7.10 Operation Space	82
5.7.11 Command.....	82
5.7.12 Connection.....	82
5.7.13 Posture Setting	83
5.7.14 Global Variables	84
5.7.15 Text File Manager	84
5.7.16 Service Engine Setting.....	84
5.7.17 Motion Setting	84
5.8 System Setting	85
5.8.1 Language.....	85
5.8.2 System Update	86
5.8.3 Group	87
5.8.4 User Account.....	87
5.8.5 Network Setting.....	88
5.8.6 Import/Export	89
5.8.7 Date Time.....	90
5.8.8 Administrator Setting.....	91

5.8.9 Network Service	91
5.8.10 Backup\Restore	93
5.8.11 Input/Display Devices	93
5.8.11.1 Pop-out Keyboard	93
5.8.11.2 Input Devices (HW 3.2 or newer exclusive)	94
5.8.12 Auto Remote Mode	95
6. Point and Base	97
6.1 Overview	97
6.2 Base and Right-hand Rule	98
6.2.1 Right-hand Rule	98
6.2.2 Types of Base	98
6.2.2.1 Robot Base	98
6.2.2.2 Vision Base	99
6.2.2.3 Custom Base	99
6.2.2.4 Tool Coordinate	100
6.3 Point Parameter	100
6.3.1 Base Shift	101
6.3.2 Tool Shift	103
7. Create Base	105
7.1 Create Vision Base	105
7.2 Create a Custom Base	105
7.3 Create New Base Node	106
7.3.1 Create a New Base by Multiple Bases	107
7.3.1.1 Create a New Base with Two Vision Bases	107
7.3.1.2 Create a New Base with Three Vision Bases	107
7.3.2 Create a New Base with Three Points	108
7.3.2.1 Create a New Base with Three Points on the Vision Base	109
7.3.2.2 Create a New Base with Three Dynamic Points	110
8. Create the TCP	111
8.1 Overview	111
8.2 TCP Setting	111
8.2.1 Create Parameters of TCP with Hand Guidance Teaching	112
8.2.2 Create Tool Center Point by Input Parameters	115
9. Motion Programming	117
9.1 Overview	117
9.2 Point to Point (PTP)	118

9.2.1 PTP is the Fastest Way to Move.....	118
9.2.2 Speed of PTP Motion.....	118
9.2.3 Plan for PTP Movement.....	119
9.2.4 PTP Smart Pose Choosing.....	119
9.3 Line.....	120
9.3.1 Line Moves the Shortest Distance.....	120
9.3.2 Speed of Line Motion.....	120
9.3.3 Plan for Line Movement.....	121
9.4 Two-Steps Motion (WayPoint).....	122
9.4.1 WayPoint.....	122
9.4.2 Plan for WayPoint Movement.....	123
9.5 Blending.....	124
9.5.1 Blending in Movement.....	124
9.5.2 Blending Speed Change Chart.....	124
9.5.3 Set the Blending Percentage.....	124
9.5.4 Set the Blending by Radius.....	125
9.6 Motion Nodes.....	125
9.6.1 Point Node.....	127
9.6.1.1 Generation Method of Point node.....	127
9.6.1.2 Point Node Setting.....	128
9.6.2 F-Point Node.....	128
9.6.3 Move Node.....	130
9.6.3.1 Plan for the Move Node.....	131
9.6.4 Circle Node.....	131
9.6.4.1 Circle Node Setting.....	131
9.6.4.2 Set Angle= 0°.....	132
9.6.4.3 Set Angle > 0°.....	132
9.6.5 Path Node.....	133
9.6.5.1 Path and PLine.....	133
9.6.5.2 Path Node Setting.....	133
9.6.5.3 Path File Import and Export.....	135
9.6.6 Pallet Node.....	135
9.6.7 Listen Node.....	137
10. Logic Programming.....	139
10.1 Overview.....	139
10.2 Variable System.....	139

10.2.1 Local Variables.....	139
10.2.1.1 Global Variables	140
10.3 Logic Nodes.....	142
10.3.1 Start Node.....	142
10.3.2 SET Node	142
10.3.3 IF Node	146
10.3.4 WaitFor Node	147
10.3.5 Gateway Node	147
10.3.6 M-Decision Node	148
10.4 Process.....	149
10.4.1 Process Nodes.....	149
10.4.2 Subflow Node.....	151
10.4.3 Thread.....	153
11. Vision Node.....	154
12. Communication and Display	156
12.1 Modbus.....	156
12.1.1 Modbus System Hardware Structure	156
12.1.2 Modbus System Software Structure	156
12.1.2.1 Set Modbus TCP	156
12.1.2.2 Set Modbus RTU.....	157
12.1.3 Application of Modbus in Project.....	157
12.2 Network	161
12.2.1 Network Node	162
12.3 IO.....	163
12.3.1 User Defined IO	163
12.3.2 External IO	164
12.3.3 Status IO.....	164
12.4 Command Node	165
12.4.1 TmComm Instruction Set	166
12.4.2 File Command.....	171
12.5 Log Node	174
12.6 Display Node	177
12.7 Voice Node	177
13. Component	179
14. Force Related Node.....	182
14.1 Compliance node.....	182

14.2 F/T Sensor.....	186
14.2.1 Communication Setting.....	186
14.2.2 Position Setting.....	187
14.2.3 Import/Export Settings of F/T Sensor.....	189
14.2.4 Force Value and Charts.....	189
14.3 Touch Stop Node.....	190
14.3.1 Function Type: Compliance.....	190
14.3.2 Function Type: Line.....	191
14.3.3 Touch Stop Function Type: Force Sensor.....	193
14.4 Smart Insert Node.....	195
14.4.1 Approaching.....	195
14.4.1.1 Approaching principle description.....	195
14.4.1.2 Approaching parameters setting.....	196
14.4.2 Searching.....	197
14.4.2.1 Method for searching: Sprial.....	198
14.4.2.2 Method for searching: Linear.....	199
14.4.3 Pushing.....	200
14.4.3.1 Parameter Setting.....	200
14.5 Force Control Node.....	201
15. Operation Space.....	209
15.1 Overview.....	209
15.2 Operation Space Setting Page.....	210
15.3 Add / Modify Page.....	211
15.3.1 Plane Page.....	211
15.3.2 Cube Page.....	212
15.4 Operation Space Setting Page in the Project Editing Page.....	213
15.5 Export/Import Operation Space.....	215
15.5.1 Export Operation Space.....	215
15.5.2 Import Operation Space.....	215
16. TM Component Editor.....	218
16.1 Starting to create your first component.....	218
16.1.1 Overview.....	218
16.1.2 TM Component Editor settings.....	218
16.1.2.1 Start node.....	218
16.1.2.2 Node settings.....	221
16.1.3 TM Component Editor Naming Rule.....	223

16.1.3.1 Component Naming	223
16.1.3.2 Global Variables Naming	224
16.2 Devices	225
16.2.1 Modbus Devices	225
16.2.2 Network Devices	225
16.2.3 Force Sensing Devices	226
16.3 Features & Applicable Examples	226
16.3.1 Global Variables	226
16.3.2 Use component in TM Component Editor	227
16.3.3 Component Inheritance	228
16.3.4 The example of point parameterization application	228
16.3.5 The example of making parameterized devices	231
16.3.6 Use thread in TM Component Editor	231
16.3.7 Use subflow in TM Component Editor	232
16.3.8 Hide parameters	232
16.4 Using your component	232
16.4.1 Open the component	232
16.4.2 Import/Export Components	233
17. Collision Check Node	234
Appendix A: Modbus List	235
Appendix B: Display of Indication Light Ring	253
Appendix C: Tables of Safety Parameter Upper and Lower Bounds	257
Appendix D: Ethernet Slave Data Table	265
Appendix E: PROFINET Data Table	271
Appendix F: Error Descriptions and Suggestions	275

Figures

Figure 1: Release the Emergency Switch	25
Figure 2: The Three Lights on The Robot Stick Flashing	25
Figure 3: The Indication Light Ring of The End Module Flashing in Light Blue	25
Figure 4: The Recommended Operating Sequence of Moving the Joints of TM Robot from Packing Pose to Safe Posture	26
Figure 5: The Recommended Operating Sequence of Moving the Joints of X series TM Robot from Packing Pose to Safe Posture	26
Figure 6: The Indication Light Ring of The End Module Returns to Blue Light	27
Figure 7: The Normal Poses	28

Figure 8: Release the Emergency Switch of Robot Stick.....	28
Figure 9: The Power Light on The Robot Stick Flashing.....	28
Figure 10: Wireless Access Point Connection Method (1/2).....	30
Figure 11: Wireless Access Point Connection Method (2/2).....	30
Figure 12: Wired Network Connection Method (1/2).....	32
Figure 13: Wired Network Connection Method (2/2).....	32
Figure 14: Safety Setting.....	34
Figure 15: Angle Setting.....	35
Figure 16: Human – Machine Safety Settings (1/2).....	36
Figure 17: Human – Machine Safety Settings (2/2).....	38
Figure 18: Safety IO Settings.....	39
Figure 19: Auto Mode / Manual Mode (1/3).....	45
Figure 20: Auto Mode / Manual Mode (2/3).....	45
Figure 21: Auto Mode / Manual Mode (3/3).....	45
Figure 22: The Robot Stick for HW 3.2 or newer.....	46
Figure 23: Build and Run Your First Project (1/5).....	47
Figure 24: Build and Run Your First Project (2/5).....	47
Figure 25: Build and Run Your First Project (3/5).....	48
Figure 26: Build and Run Your First Project (4/5).....	49
Figure 27: Build and Run Your First Project (5/5).....	49
Figure 28: Shutdown.....	50
Figure 29: Function Menu.....	51
Figure 30: Get/Release Control (Local).....	52
Figure 31: View.....	53
Figure 32: Display.....	54
Figure 33: IO.....	55
Figure 34: Simulator.....	56
Figure 35: Status.....	56
Figure 36: Vision Viewer.....	57
Figure 37: Single Project Icon.....	58
Figure 38: Project Editing Page.....	59
Figure 39: Open and Delete Project View.....	61
Figure 40: Step Run.....	62
Figure 41: Point Manager (1/2).....	63
Figure 42: Point Manager (2/2).....	63
Figure 43: Base Manager.....	64

Figure 44: Controller.....	65
Figure 45: Controller (IO Control).....	66
Figure 46: Controller (FreeBot Control).....	67
Figure 47: EditBlock	69
Figure 48: Base List	70
Figure 49: Tool List.....	70
Figure 50: Display Manager	71
Figure 51: Project Edit (1/3)	71
Figure 52: Project Edit (2/3)	72
Figure 53: Project Edit (3/3)	73
Figure 54: Project Function Menu	73
Figure 55: Searching Pane.....	74
Figure 56: Stop Watch Setting Page.....	75
Figure 57: View Tool Floating Window.....	76
Figure 58: Serial Port (1/2).....	76
Figure 59: Serial Port (2/2).....	77
Figure 60: Robot Setting	79
Figure 61: Output Default Value Setting.....	80
Figure 62: Speech Setting.....	81
Figure 63: Gripper Button.....	81
Figure 64: Posture Setting.....	83
Figure 65: System Setting	85
Figure 66: Language Setting	86
Figure 67: System Update (1/2)	86
Figure 68: System Update (2/2)	87
Figure 69: Group	87
Figure 70: User Account.....	88
Figure 71: Network Setting (1/2)	88
Figure 72: Network Setting (2/2)	89
Figure 73: Date Time.....	91
Figure 74: Administrator Setting.....	91
Figure 75: Network Services	92
Figure 76: Backup\Restore.....	93
Figure 77: Pop-out Keyboard	94
Figure 78: Input Devices	94
Figure 79: Auto Remote Mode (1/2).....	95

Figure 80: Auto Remote Mode (2/2).....	96
Figure 81: Base Value of the Point.....	97
Figure 82: Coordinate Axis Rotation	97
Figure 83: Right-Hand Base	98
Figure 84: Robot Base	99
Figure 85: Servoing Vision Base is on the Camera.....	99
Figure 86: Fix-point Vision Base is on the Object	99
Figure 87: Tool Coordinates	100
Figure 88: Point Parameter Information	101
Figure 89: Shift Function of Point Node	101
Figure 90: Base Shift Schematic Diagram	102
Figure 91: Node with Base Shift.....	102
Figure 92: Node with Tool Shift.....	103
Figure 93: Tool Shift Using Keep Pose	103
Figure 94: Tool Shift Using Keep Path	104
Figure 95: Base Manager	105
Figure 96: Build a Base by 3 Points	106
Figure 97: New Base Node	107
Figure 98: Create a New Base with Two Vision Bases	107
Figure 99: Create a New Base with Three Vision Bases	108
Figure 100: Create a New Base with Three Points	109
Figure 101: Create a New Base with Three Points on the Vision Base	109
Figure 102: Create a New Base with Three Dynamic Points	110
Figure 103: TCP Definition	111
Figure 104: TCP Setting.....	112
Figure 105: Set the times of calibration.....	113
Figure 106: Teaching Screen	113
Figure 107: The Robot Posture Needs to Change during Teaching (1/2).....	114
Figure 108: The Robot Posture Needs to Change during Teaching (1/2).....	114
Figure 109: Save Teaching Result.....	115
Figure 110: Manual Input TCP Values	116
Figure 111: TM Robot Motion Types.....	117
Figure 112: PTP Motion	118
Figure 113: Speed of PTP Motion	119
Figure 114: PTP Application Examples.....	119
Figure 115: PTP Smart Pose Choosing	120

Figure 116: Line Motion Simulation.....	120
Figure 117: Speed of Line Motion	120
Figure 118: Link to Project Speed	121
Figure 119: Line Application Example.....	122
Figure 120: WayPoint Motion Status.....	122
Figure 121: WayPoint Setting.....	123
Figure 122: WayPoint Application Examples	123
Figure 123: Blending in Space	124
Figure 124: Blending Speed Change Chart	124
Figure 125: Set the Blending Percentage or Set the Blending by Radius.....	125
Figure 126: Motion Nodes Support Variable as the Inputs.....	126
Figure 127: Speed Adjust and Speed Indication on the Node.	127
Figure 128: Point Node	127
Figure 129: Point Node Setting	128
Figure 130: F-Point Node	129
Figure 131: F-Point Node Setting.....	129
Figure 132: Adjust F-Point Parameter during Project Running	130
Figure 133: Move Node Setting.....	130
Figure 134: Plan for the Move Node	131
Figure 135: The Circle Node Plans Arc Path with 3-Point Setting Circle	131
Figure 136: Circle Node Setting	132
Figure 137: The Circle Motion Status of Set Angle = 0°	132
Figure 138: The Circle Motion Status of Set Angle =270°	133
Figure 139: PLine Blending Relationship Chart	133
Figure 140: Path Node Setting	134
Figure 141: Pallet Node (1/2)	135
Figure 142: Pallet Node (2/2)	136
Figure 143: Pallet Patterns	136
Figure 144: Listen Node	137
Figure 145: Variable System	139
Figure 146: Global Variable Setting	141
Figure 147: Global Variables after Project Is Run	141
Figure 148: SET Node.....	143
Figure 149: Variable Count	143
Figure 150: Expression Editor Parameters (1/2).....	144
Figure 151: Expression Editor Parameters (2/2).....	145

Figure 152: Add Expression	145
Figure 153: Analog I/O Setting	146
Figure 154: IF Node	146
Figure 155: IF Node Stop Criteria Setting	147
Figure 156: Gateway Node Judges Five Conditions	148
Figure 157: IF Node Judges Four Conditions	148
Figure 158: Stop Node Ends Project.....	149
Figure 159: Goto Node Flow Transfer.....	150
Figure 160: Goto Node Connection.....	150
Figure 161: Warp Node Transfers to another Project	150
Figure 162: Subflow Node Modularization Concept.....	151
Figure 163: Menu to Create Subpages	152
Figure 164: Select a subflow in the subflow node (1/2).....	152
Figure 165: Select a subflow in the subflow node (2/2).....	153
Figure 166: Thread.....	153
Figure 167: Vision Node.....	154
Figure 168: Vision Node Flow	154
Figure 169: Vision Node Setting.....	155
Figure 170: Robot Modbus Protocol.....	156
Figure 171: Modbus Device Access.....	157
Figure 172: Modbus TCP Local IP	158
Figure 173: Modbus Device Setting	159
Figure 174: Modbus X Axis Position Parameter Setting	160
Figure 175: Save the Variable of Modbus Value.....	160
Figure 176: Use the obtained variable of SET node to obtain the value of Modbus	161
Figure 177: Display displays the value obtained by Modbus	161
Figure 178: Network Setting.....	162
Figure 179: Status IO Setting (1/2).....	164
Figure 180: Status IO Setting (2/2).....	165
Figure 181: Instruction Set Communicates with HMI	165
Figure 182: Enable TmComm Instruction Set	166
Figure 183: Directive Summary Flow	168
Figure 184: Command Node Gets RS-232 Information	168
Figure 185: Set and Open Serial Port (1/2).....	169
Figure 186: Set and Open Serial Port (2/2).....	169
Figure 187: Read Data and Receive as a Variable	170

Figure 188: SET Node Setting	171
Figure 189: Display Node Displays the Obtained Value	171
Figure 190: Remotely Add Notepad and Write information	173
Figure 191: Display Node Displays Received Variables	174
Figure 192: Remotely Delete Notepad File	174
Figure 193: Log Node Gets the Current Angle	175
Figure 194: Modbus Setting	175
Figure 195: SET Node Setting and Log of Thread Page.....	176
Figure 196: Node Text Example.....	176
Figure 197: Display Node Displays the Robot's Position	177
Figure 198: Voice Node in TMflow Application.....	178
Figure 199: Select Components	179
Figure 200: Robot Setting Page Component	180
Figure 201: Gripper Button Setting Page	181
Figure 202: Compliance Node.....	182
Figure 203: Compliance Node Teach Setting	184
Figure 204: Line Direction	185
Figure 205: Rotation Direction.....	185
Figure 206: Compliance Variable Selection	185
Figure 207: F/T Sensor	186
Figure 208: Read Values after Setting F/T Sensor	187
Figure 209: Position Setting	188
Figure 210: Select Position Setting	188
Figure 211: Input Values	189
Figure 212: Charts.....	189
Figure 213: Touch Stop-Compliance Settings.....	190
Figure 214: Touch Stop-Line Settings.....	192
Figure 215: Force Sensor.....	193
Figure 216: Force Sensor.....	194
Figure 217: Approaching Principle	196
Figure 218: Approaching Parameter Setting	197
Figure 219: Spiral Searching Method.....	197
Figure 220: Line Searching Method (1/2).....	198
Figure 221: Line Searching Method (2/2).....	198
Figure 222: Spiral Searching Parameter Setting Interface.....	199
Figure 223: Linear Searching Parameter Setting Interface	200

Figure 224: Pushing Parameter Interface	201
Figure 225: Force Control Node Settings	202
Figure 226: Tool Coordinate System.....	202
Figure 227: Base Coordinate System	203
Figure 228: Trajectory Coordinate System.....	203
Figure 229: Possible Conversion Error	204
Figure 230: F/T Operation Modes – Setpoint	205
Figure 231: F/T Operation Modes – Trajectory (1/3).....	206
Figure 232: F/T Operation Modes – Trajectory (2/3).....	206
Figure 233: F/T Operation Modes – Trajectory (3/3).....	206
Figure 234: Stop Criteria – F/T Reached	207
Figure 235: Operation Space Setting	210
Figure 236: Plane	211
Figure 237: Cube (1/2)	212
Figure 238: Cube (2/2)	213
Figure 239: Project Editing Page and Operation Space Setting	214
Figure 240: Click the Save Button to Save the File	215
Figure 241: Start Node	219
Figure 242: Component Icon Resolution	220
Figure 243: Node Setting (1/2)	222
Figure 244: Node Setting (2/2)	223
Figure 245: Global Variables Naming	225
Figure 246: Global Variables.....	227
Figure 247: The Example of Point Parameterization Application (1/4).....	228
Figure 248: The Example of Point Parameterization Application (2/4).....	229
Figure 249: The Example of Point Parameterization Application (3/4).....	230
Figure 250: The Example of Point Parameterization Application (4/4).....	230
Figure 251: The Example of Making Parameterized Devices	231
Figure 252: Hide Parameters	232
Figure 253: Open the Component.....	233
Figure 254: Collision Check Node.....	234

Tables

Table 1: Hardware Versions and Applicability	21
Table 2: Warning and Caution Symbols	22
Table 3: Functional Note Symbols	23

Table 4: Keyboard Hot Keys in TMflow	59
Table 5: FreeBot Degree of Freedom Limitation	68
Table 6: User Defined IO Setting Table	80
Table 7: Valid Blending Setting (Moving from P1 to P2)	125
Table 8: Variable Data Types	140
Table 9: SET Syntax List.....	143
Table 10: If Judgment Operators.....	147
Table 11: TM Robot Coordinates in the Modbus List.....	157
Table 12: User Defined IO Setting Table	163
Table 13: TmComm Instruction set	167
Table 14: File Commands	173
Table 15: Spiral Searching Function Setting Parameters Definition	199
Table 16: Linear Searching Function Setting Parameter Definition	200
Table 17: Pushing Parameter Definitions	201
Table 18: Component Naming	224
Table 19: Naming Rule for Items after Components	224
Table 20: Modbus – Classify	235
Table 21: Modbus – Robot Status 1	235
Table 22: Modbus – Robot Status 2.....	236
Table 23: Modbus – Control Box DI/O	237
Table 24: Modbus – End Module	237
Table 25: Modbus – Control Box AI/O.....	237
Table 26: Modbus – External Module.....	238
Table 27: Safety Connector (1/2)	238
Table 28: Safety Connector (2/2)	239
Table 29: Modbus – Robot Coordinate	241
Table 30: Modbus – Robot Coordinate (When Touch Stop node is triggered)	242
Table 31: Modbus – Run Setting.....	243
Table 32: Modbus – TCP Value	244
Table 33: Modbus – Robot Stick	244
Table 34: Modbus - Project Speed.....	244
Table 35: Modbut - End Module Button.....	245
Table 36: Modbus – Stick Status (Pressed).....	245
Table 37: Modbus – TCP Speed	246
Table 38: Modbus – TCP Force	246
Table 39: Modbus – Joint Torque.....	246

Table 40: Modbus – Joint Speed.....	247
Table 41: Modbus – Joint Current.....	247
Table 42: Modbus – Joint Temperature	247
Table 43: Modbus – Current Base	247
Table 44: Modbus – Safety Stop Criteria	248
Table 45: Modbus – Collaborative Mode.....	249
Table 46: Modbus – Running Timer	249
Table 47: Modbus – Up Time	249
Table 48: Modbus – Others 1.....	250
Table 49: Modbus – Others 2.....	251
Table 50: Modbus – Others 3.....	252
Table 51: Modbus – Others 4.....	252
Table 52: Blinking Ratio	254
Table 53: Light Indications	255
Table 54: Quick References of Color/Blinking.....	256
Table 55: Safety Parameter Table - TM5-700/ TM5M-700	257
Table 56: Safety Parameter Table - TM5X-700	258
Table 57: Safety Parameter Table - TM5-900/ TM5M-900	259
Table 58: Safety Parameter Table - TM5X-900	260
Table 59: Safety Parameter Table - TM14/ TM14M.....	261
Table 60: Safety Parameter Table - TM14X.....	262
Table 61: Safety Parameter Table - TM12/ TM12M.....	263
Table 62: Safety Parameter Table - TM12X.....	264
Table 63: Ethernet Slave Data Table	270

Revision History Table

Revision Code	Date	Revised Content
01	October 2018	Original release
02	December 2018	Software update from 1.68.6000 to 1.68.6800. Redefined the LED light color and added safety monitoring functions to hand guiding. Updated Chapter 4. Minor test fixes. Added Appendix B for indication light ring display.
03	July 2019	Added 1.72.3500 features
04	August 2019	Added X model information
05	December 2019	Added 1.76.3300 features
06	April 2020	Added 1.76.6300 features
07	August 2020	Added 1.80 features

1. General

1.1 Overview

TMflow is a graphical HMI. Its purpose is to provide users with a complete, convenient and simple interface for robot motion and logic programming environments. Through the graphical HMI, users can simply manage and set the parameters of the robot, and use the graphical flow chart to plan the robot movement and process logic. At the same time, the interface design of **TMflow** considers the use of touch screens, allowing you to manage multiple robots from a single Windows tablet.

Users and system integrators of TM Robot must read and fully understand this chapter before using this robot. In addition, before users perform any operation on the robot in accordance with this manual, it is necessary to read and comply with the *Safety Manual* for the corresponding product's hardware and software version, and the *Hardware Installation Manual* for the corresponding hardware version, before the operation can be performed.

This manual applies to TMflow Version 1.80 or above. Confirm your software version before using and reading this manual. To check the software version, click  on the interface on TMflow.

The applicability of this software to the hardware versions of each TM Robot is as follows:

Hardware Version	Applicability
HW 3.0, 3.1, 3.2	Applicable

Table 1: Hardware Versions and Applicability

1.2 Warning and Caution Symbols

The Table below shows the definitions of the warning and caution levels used in this manual. Pay close attention to them when reading each paragraph, and observe them to avoid personal injuries or equipment damage.



DANGER:

Identifies an imminently hazardous situation which, if not avoided, is likely to result in serious injury, and might result in death or severe property damage.



WARNING:

Identifies a potentially hazardous situation which, if not avoided, will result in minor or moderate injury, and might result in serious injury, death, or significant property damage.



CAUTION:

Identifies a potentially hazardous situation which, if not avoided, might result in minor injury, moderate injury, or property damage.

Table 2: Warning and Caution Symbols

1.3 Safety Precautions



DANGER:

This product can cause serious injury or death, or damage to itself and other equipment, if the following safety precautions are not observed:

- All personnel who install, operate, teach, program, or maintain the system must read the *Hardware Installation Manual*, *Software Manual*, and *Safety Manual* for the software and hardware version of this product, and complete a training course for their responsibilities in regard to the robot.



Read Manual Label



Impact Warning

- All personnel who design the robot system must read the *Hardware Installation Manual*, *Software Manual*, and *Safety Manual* for the software and hardware version of this product, and must comply with all local and national safety regulations for the location in which the robot is installed.
- The TM Robot shall be used according to its intended use.
- Results of the risk assessment may require the use of additional risk reduction measures.
- Power to the robot and its power supply must be locked out and tagged out or have means to control hazardous energy or implement energy isolation before any maintenance is performed.
-  Dispose of the product in accordance with the relevant rules and regulations of the country or area where the product is used.

1.4 Validation and Responsibility

The information provided in this Manual does not include how to design, install and operate a complete arm application, nor does it involve the peripheral devices that will affect the overall system safety. The design and installation of the complete system must comply with the standards and regulations for safety requirements in the country located. Users or integrators should understand safety laws and safety regulations in the local country, and avoid major risks present in the entire system.

This includes but is not limited to:

- Risk assessment of the whole system
- Adding other machines and additional risk reduction measures based on the results of the risk assessment
- Using appropriate software safety features
- Ensuring the user will not modify any safety measures
- Ensuring all systems are correctly designed and installed
- Clearly labeling user instructions
- Clearly marked symbols for installation of the robot arm and the integrator contact details
- Making accessible relevant documents, including the risk assessment and this manual.

1.5 Limitation of Liability

No safety-related information shall be considered a guarantee by the Corporation that a TM Robot will not cause personnel injury or property damage.

1.6 Functional Note Symbol

The following table defines the functional note symbols used in this manual. Read the paragraphs carefully.



IMPORTANT:

This symbol represents the relevant functional details to assist the programming and use.



NOTE:

This symbol represents the relevant functional use tips to assist programming efficiency

Table 3: Functional Note Symbols

2. Start up and Activation

2.1 Overview

This manual instructs users of TM Robot to perform start up procedures for the first time. Users must first read and follow the *Safety Manual* for the corresponding product's software and hardware version, and the *Hardware Installation Manual* for the corresponding hardware version to install the TM Robot correctly and properly before executing the operation of this chapter; otherwise, it may result in serious risks.



WARNING:

The following chapters of this manual will describe how to install the TM Robot after unpacking the box. If it is your first time to install TM Robot without learning all the installation process starting from unpacking the new product, especially when the robot has been installed in a working environment, pay attention to the following items in order to perform first time installation and startup operation according to this manual:

1. In order to avoid the risks of resuming work caused by the changes of the original working environment and configuration, check with the responsible person for the working environment and keep all necessary configuration records, such as software settings and all hardware wirings.
2. Remove all IOs for the external connection of the **Control Box**, including analog IO, digital IO, EtherCAT connection port and network ports. Remove all air lines or external power lines connecting to the optional equipment before Commissioning.
3. Remove all **Control Box** external USB interface, serial port, and external connection / external storage device connections of the network interface.
4. Uninstall any added objects / end-effectors installed to the end flange and any electrical connections between the end effector and the **End Module / Control Box**.
5. Uninstall any hardware that is installed outside the robot body.

2.2 Start Up

2.2.1 Plug in the Power

Plug the **Power Cable of Control Box** into the **power socket**.



WARNING:

For the procedure from product unpacking to plugging the **Power Cable of the Control Box** into the **power socket**, read and follow the corresponding contents of the *Hardware Installation Manual*.

2.2.2 Start up from Packing Pose

Step 1. Press the **Emergency Switch** of the **Robot Stick**.

Step 2. Press the **Power Button** of the **Robot Stick** to start the power supply of the **Control Box**.

Step 3. Release the **Emergency Switch** of the **Robot Stick** by twisting it a quarter-turn clockwise when the light on **Robot Stick** starts blinking.

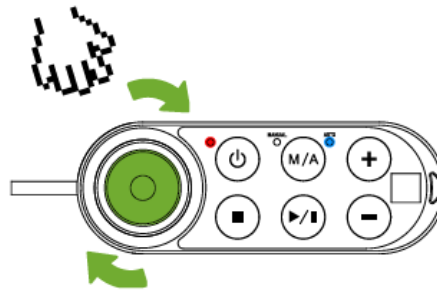

Figure 1: Release the Emergency Switch

The three lights on the **Robot Stick** keep flashing. For the buttons, lights, and switch on the **Robot Stick**, refer to the *Hardware Installation Manual*.

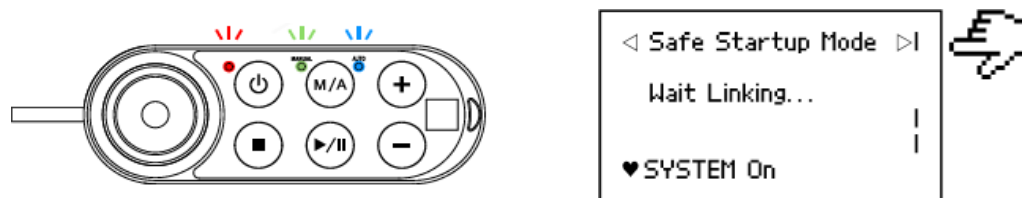

Figure 2: The Three Lights on The Robot Stick Flashing



CAUTION:

While booting up, if the **Emergency Switch** on the Robot Stick is kept pressed, the **User Connected ESTOP Input** is kept open, or the **User Connected ESTOP Input Port without Robot ESTOP Output** is kept open, the boot process cannot be complete. Follow the instructions shown on the screen to restart the robot.

Step 4. **The Indication Light Ring** of the **End Module** flashes in red during startup. After the start up is completed, the **Indication Light Ring** of the **End Module** flashes in light blue, representing that it is in the **Safe Start Up Mode**.

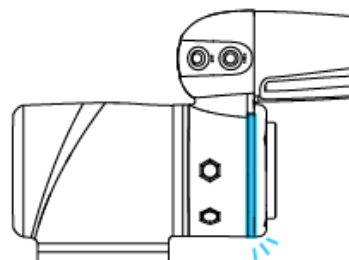

Figure 3: The Indication Light Ring of The End Module Flashing in Light Blue

Step 5. Hold the **FREE Button** on the **End Module** to release the brakes and manually move the robot to a relatively safe position. If this is the first time unpacking the robot, follow the illustrations below to release joints from initial posture.

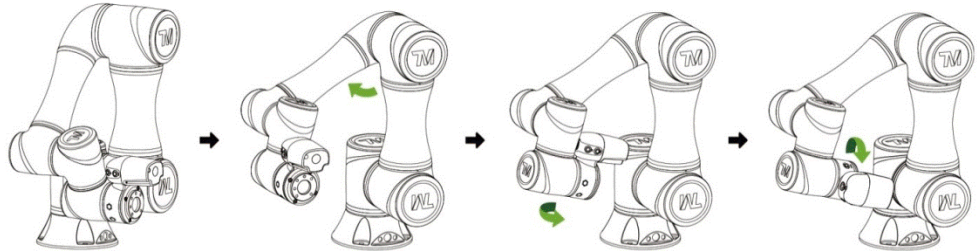

Figure 4: The Recommended Operating Sequence of Moving the Joints of TM Robot from Packing Pose to Safe Posture

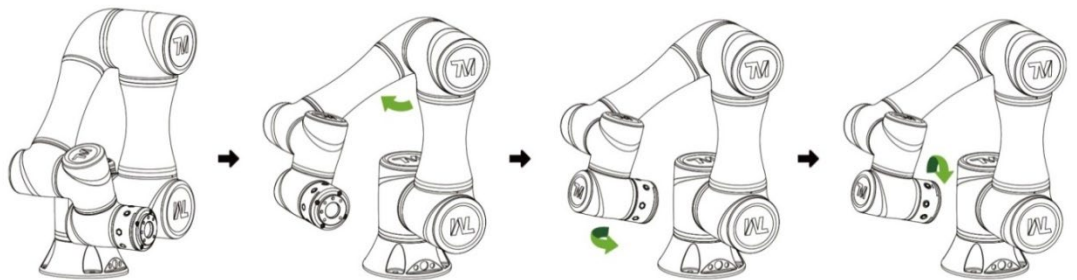

Figure 5: The Recommended Operating Sequence of Moving the Joints of X series TM Robot from Packing Pose to Safe Posture



DANGER:

Pay attention when the **FREE Button** is pressed and the brake is released. The robot's body will sag due to gravity. When the **FREE Button** is pressed to unlock the brake, be sure to support the end of robot and expect some sagging, and hold the end of robot, to prevent harm such as pinching of the Operator. If there are any problems with the robot sagging, release the **FREE Button** immediately, and the brake of each robot joint will be locked again.



DANGER:

There is no force compensation in **Safe Start Up Mode**. This means that it requires more force to move each joints directly against the motor drive.



CAUTION:

If you do not follow the above instructions to move the robot to the safe posture shown in the above figure, but continue to operate downwards to release the **Emergency Switch**, it may cause certain joints of the robot (especially the fifth joint) to be outside the joint angle limit when the robot returns to a normal state. At this time, the robot will not be able to start correctly and the red light will be on. In this condition, press the **Emergency Switch** again and repeat this step to the correct safe posture as shown in the figure.



CAUTION:

During **Joint Position Calibration**, each joint of the robot will perform a calibration motion. Make sure the robot pose is in a clear space of at least 5 degrees per joint to perform the calibration motion before calibration. At the same time, make sure the TCP, which may be a long distance from the robot flange, will not cause harm during the calibration motion.

Step 6.

Press and hold the **Stop Button** on the **Robot Stick** for about three seconds, and the robot will enter the calibration process. During calibration, joints of the robot may move slightly. After the calibration is completed, the **Indication Light Ring** of the **End Module** will return to blue light, indicating that the robot has entered the **Auto Mode** successfully and it can be used normally.

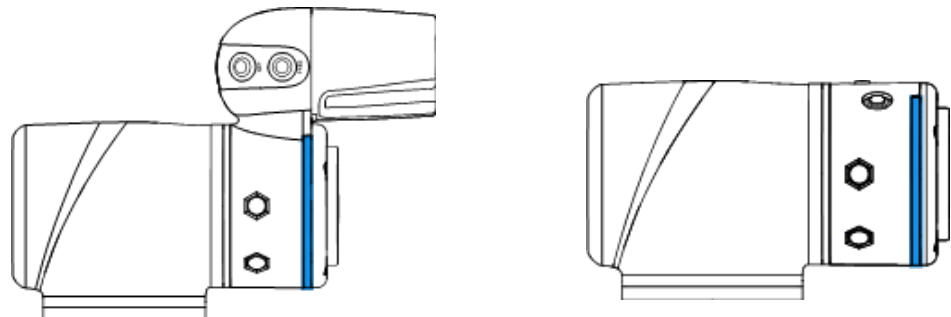

Figure 6: The Indication Light Ring of The End Module Returns to Blue Light



CAUTION:

When the startup from the Packing Pose is complete, use the **TMflow controller page** to move the robot posture to the origin first (each joint angle: 0, 0, 0, 0, 0, 0), and then use the **FreeBot** teaching to move the robot to the **Normal Pose** (each joint angle: 0, 0, 90, 0, 90, 0) as shown in the figure below. Note that the joint 2 pointing directions of the **Normal Pose** and the safe posture after unpacking the box are opposite.

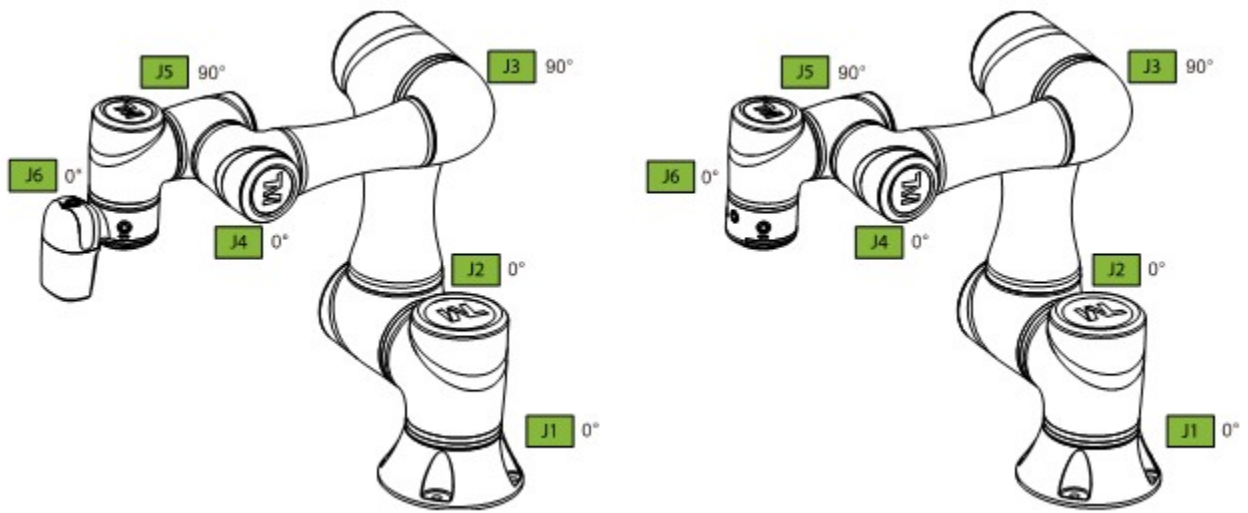

Figure 7: The Normal Poses

2.2.3 Standard Start Up

- Step 1.** Check that the robot's posture is safe.
- Step 2.** Check that the **Emergency Switch of Robot Stick** is released.

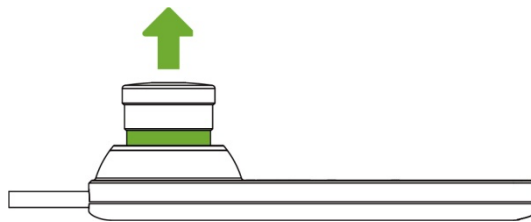

Figure 8: Release the Emergency Switch of Robot Stick

- Step 3.** Press the **Power Button** on the **Robot Stick** to start the robot.



CAUTION:

While booting up, if the **Emergency Switch** on the Robot Stick is kept pressed, the **User Connected ESTOP Input** is kept open, or the **User Connected ESTOP Input Port without Robot ESTOP Output** is kept open, the boot process cannot be complete. Follow the instructions shown on the screen to restart the robot.

- Step 4.** Check the screen on the **Control Box**. It should now indicate that the system entered startup mode. The power light on the **Robot Stick** will keep flashing, too.

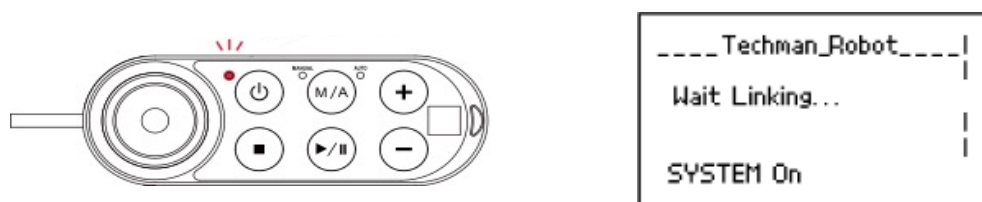

Figure 9: The Power Light on The Robot Stick Flashing

Step 5. When the controller is starting up, the **Indication Light Ring** of the **End Module** displays flashing red light. During the process, the robot will run automatic calibration, and each joint of the robot will move slightly to calibrate.



CAUTION:

During **Joint Position Calibration** period, each point of the robot will perform a calibration motion. Make sure the robot pose is in a clear space of at least 5 degrees per joint to perform the calibration motion before calibration. At the same time, make sure the TCP, which may be a long distance to the robot flange, will not cause harm during the calibration motion.

Step 6. After the controller start up is done, the **Indication Light Ring** of the **End Module** will constantly display blue light. The robot can be used normally at this time.

2.2.4 TM Robot HMI TMflow Operation

TMflow and the TM Robot can be connected in ways as below:

- Connect with the monitor, keyboard and mouse to the **Control Box**. This enables to start **TMflow**.
- Download the **TMflow Client** from customer area of the official website, and then install it on a Windows-based computer (e.g. Windows Laptop/ Windows Tablet). Connect to the robot in a wired or a wireless network.



NOTE:

Minimum requirement of the client device to install **TMflow** are as follows:

Operating System:	Windows 7 SP 1
CPU:	Intel i5 series
RAM:	4 GB
Hard Drive Space:	2 GB of available space
Display Resolution:	1366 by 768
Peripherals:	USB ports and Ethernet ports
Supported Languages:	English, Simplified Chinese, Traditional Chinese, Japanese, German, Korean, Vietnamese, Spanish, French, Italian, Danish, Dutch, Czech, Hungarian, Romanian, Portuguese, Turkish
Additional Requirements:	<ol style="list-style-type: none"> 1. 2010Redistributable_bcredist (x64/x86) 2. 2013Redistributable_bcredist (x64/x86) 3. 2015Redistributable_bcredist (x64/x86) 4. .Net Framework 4.52 or above.

2.2.4.1 Local Operation Method

- Step 1.** Connect the screen, mouse, and keyboard, to the **Control Box**.
- Step 2.** Navigate to ☰ and click **Login**.
Administrator by default is not set with password. Click **OK** to login directly.
- Step 3.** Click **Get Control** to get control of the robot.

2.2.4.2 Wireless Access Point Connection Method

- Step 1.** Install **TMflow** on client device.
- Step 2.** Connect the robot to the same physical AP or entity AP of the same network segment.

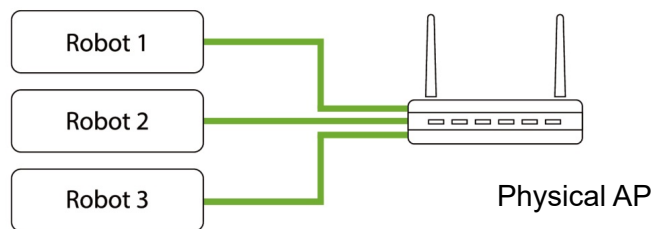

Figure 10: Wireless Access Point Connection Method (1/2)

- Step 3.** Connect the client network to the above local area network.

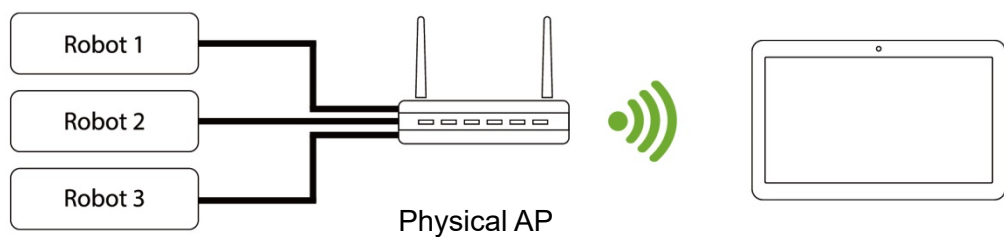



Figure 11: Wireless Access Point Connection Method (2/2)

- Step 4.** Open **TMflow** on the client device, click the upper left corner 🔄 to refresh the robot list, and wait for the corresponding Robot name to appear on the connection screen.
- Step 5.** Click the robot icon twice to connect with the robot. Ensure that all the robots in this network segment appear in the screen. Users can distinguish which robot to be connected by the robot's Robot ID (the number displayed below the QR code on the **Robot Stick**).

- Step 6.** When the robot connection is successful, the  icon will appear in the screen on the robot and the robot icon will appear in the upper right corner.
- Step 7.** Click **Get Control** to control the robot.



CAUTION:



Do not mistakenly insert the network cable into the dedicated **EtherCAT port** of the **Control Box**. This action will trigger a robot error.



NOTE:

The connected device will display a green icon, and any other device will display a red icon.

2.2.4.3 Wired Network Connection Method

- Step 1.** Install **TMflow** on the client device.
- Step 2.** Connect the robot and client device to the same physical AP or the physical AP on the same network segment, or connect the two ends of the network wires to the robot **Control Box** and Client.
- Step 3.** Connect the client network to the above local area network.
- Step 4.** Open **TMflow** on the client device, click the upper left corner  to refresh the robot list, and wait for the corresponding Robot ID to appear on the connection screen.
- Step 5.** Click the robot icon twice to connect with the robot. Ensure that all robots in this network segment appear in the screen. Users can distinguish which robot to be connected by the robot's Robot ID.
- Step 6.** When the robot connection is successful, the icon  will appear on the robot in the screen and the icon of robot appears on the upper right corner.
- Step 7.** Click **Get Control** to control the robot.

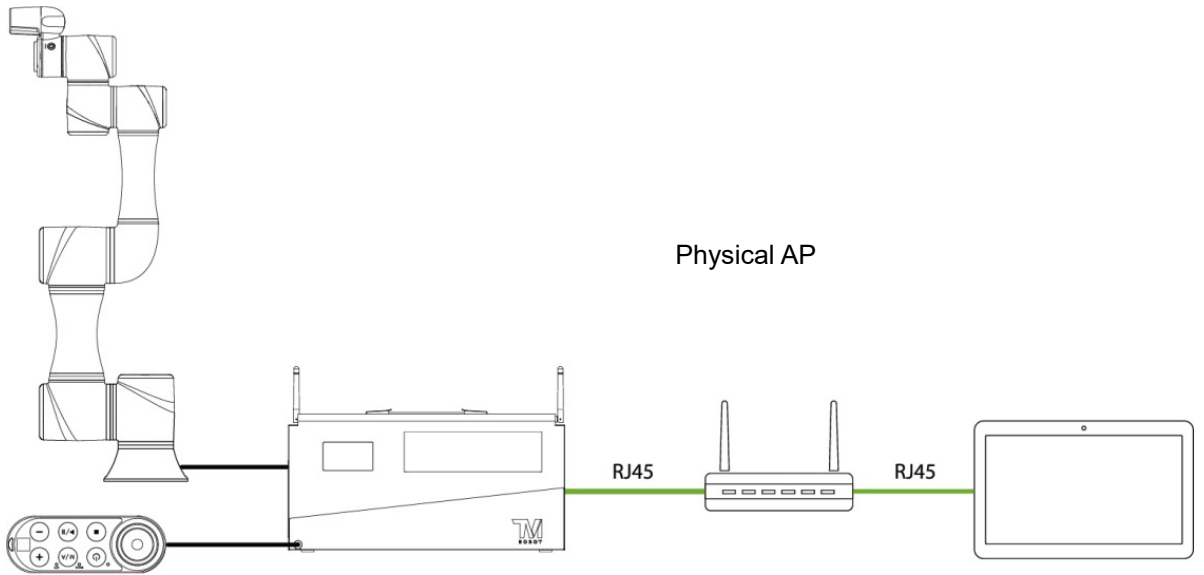

Figure 12: Wired Network Connection Method (1/2)

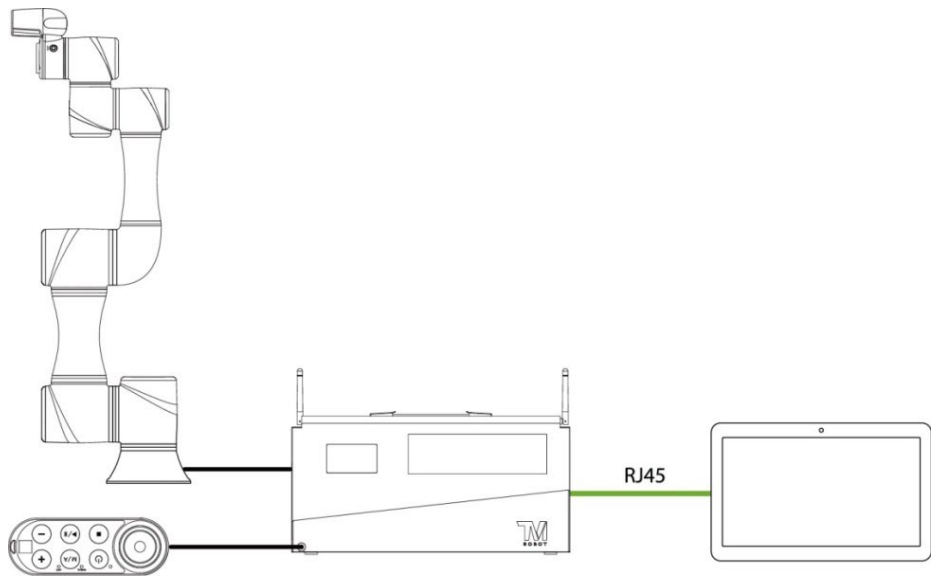

Figure 13: Wired Network Connection Method (2/2)

3. Safety Settings

3.1 Overview

This chapter will introduce the safety settings interface of the TM Robot, including the Safety Permission Settings and Safety Setting.

Note

NOTE:

Upgrading the software with previous versions of hardware will not upgrade the version of the safety system.

3.2 Safety Permission Settings

Users and administrators of TM Robot must set appropriate account password permissions before starting to use the TM Robot, with appropriate arrangements for access to operator permission for safety configuration.

When users have completed the startup and activation according to the previous chapter, and entered the **TMflow** interface with the default account password to get the control of robot, navigated to **≡** and clicked **Setting** to enter the setting page, an option labelled **Safety** will appear on this page. This is the safety setting operation area of the product as well as all important settings for the robot. If settings are altered arbitrarily, it will cause danger during operation. For proper permission settings, refer to 5.8.3 Group and 5.8.4 User Account to create accounts for authorization to access the safety related setting permissions and grant permission to access **Setting**, and set all other account and group privileges to access **Setting** to change the safety permission settings.

3.3 Safety Setting

On the **Safety Setting** page, there are functions including **Performance Safety Settings**, **Human – Machine Safety Settings**, **Safety IO Settings**, **Cartesian Limit A**, **Cartesian Limit B**, and **Project Speed Adjustment Setting**. These function returns a Safety Checksum at the left of the item separator line at top right to verify the system integrity. Changes in these functions renew the Safety Checksum if saved. There is also a timestamp of the last modified date and time at the bottom left of the screen. The timestamp is updated and expressed according to ISO 8601 every time users click the **Save** button for new parameters.

Note

NOTE:

In TMflow Software version 1.74 and earlier versions:

- **Performance Safety Settings** is named **Safety Stop Criteria**.
- **Human – Machine Safety Settings** is named **Collaborative Mode Setting**.
- **Safety IO Settings** is named **Safeguard Port Setting**.
- **Cartesian Limit** is not available.

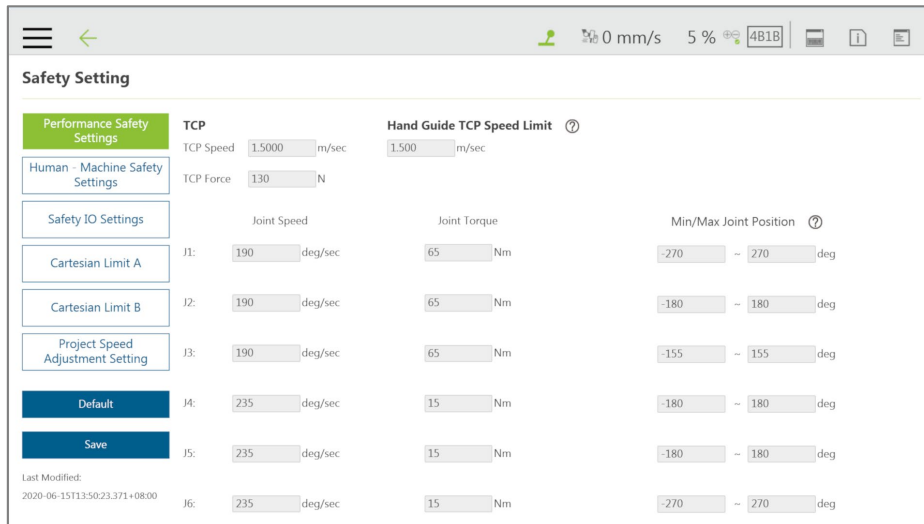

Figure 14: Safety Setting

3.3.1 Performance Safety Settings

On this page, users can set the TCP speed of the robot, the force of the TCP, the **Hand Guide TCP Speed Limit** as an individual speed limit categorized as a cat.2 stop, as well as the speed, the torque, and the position of each joint. For the related physical meanings and the definition of the safety functions and the precautions that they represent, read and follow the instructions in the *Safety Manual* before the operation or setting can be performed. Users can refer to [Appendix C](#) for values applicable to each model.

Note

NOTE:

When using with Hand Guide, if the pull speed by hand reaches to the Hand Guide TCP Speed Limit, users will feel the resistance feedback. Under such circumstances, lower the strength to pull to keep from triggering the protective stop.

The default value of the stop criteria is designed to provide a relatively safer working capability of the robot. A higher upper limit can be set by users. If users want to reach 100% project speed without triggering these stop criteria, set the limit to the upper limit for each input slot. Since the capability of the robot is still related to the pose, motion, TCP length, and payload, without these stop criteria, the robot is still protected by the maximum allowable torque of each joint and stops. In addition, regarding the life of the robot, refer to the *Hardware Installation Manual* of the

respective model for the value of rated torque and the limit for repeated peak torque of each joint.



CAUTION:

Angle Setting:

For example, when the first joint position is set to 270° and -270°, then the angle range in 270°~ 271° and -270°~ -271° will become reducing range shown as the blue area in the figure. When joint 1 moves into this range, the basic moving speed of the robot will be switched to 250mm/sec for line motion and 5% for PTP motion, to form an angle buffer region to prevent possible overshoot to the joint limit. At the same time, the angle range in 271°~ 274° and -271°~ -274° is the 2nd buffer range for joint limit as the red area in the figure. When the joint angle arrives this area robot will stop moving. Users can only operate the robot by pressing **FREE Button** to make the robot leave this area.

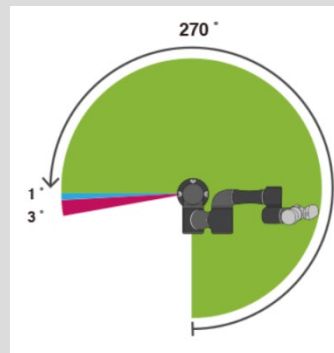

Figure 15: Angle Setting



CAUTION:

For different TM Robot models the maximum angle limits of each joint may be different. Refer to the product specifications according to the product model and hardware version.

3.3.2 Human – Machine Safety Settings

When User Connected External Safeguard Input Port for Human – Machine Safety Settings is triggered, TM Robot will run at a slower speed and a lower joint torque stop criteria by the users' settings. At this time, a purple light will be added to the **Indication Light Ring** for users to distinguish whether the robot is switch into Human – Machine Safety Settings. Users can refer to [Appendix C.](#) for values applicable to each model.



DANGER:

Note that the functions described in this section are only to assist users in setting the Human – Machine safety parameters and settings more conveniently. Users should still perform complete risk assessment according to the robot use environment and conditions before the robot is used. TM Robot clearly specifies the following potential residual risks: There is a risk that causes the robot to hit a human body at full speed due to improper use of safe space settings or by running incorrect projects.



DANGER:

If using the Compliance function in **TMflow**, speed is not controlled in **Human - Machine Safety Settings**. The robot will still run **Compliance** function according to the force you set. If you want to use **Compliance** function with **Human - Machine Safety Setting**, complete a complete risk assessment and set appropriate force values.

The parameters of **Human – Machine Safety Settings** can be divided into two parts: one is **Body Region Risk Setting** and the other is **More Limit Setting**. The **Body Region Risk Setting** page is shown in the figure below.

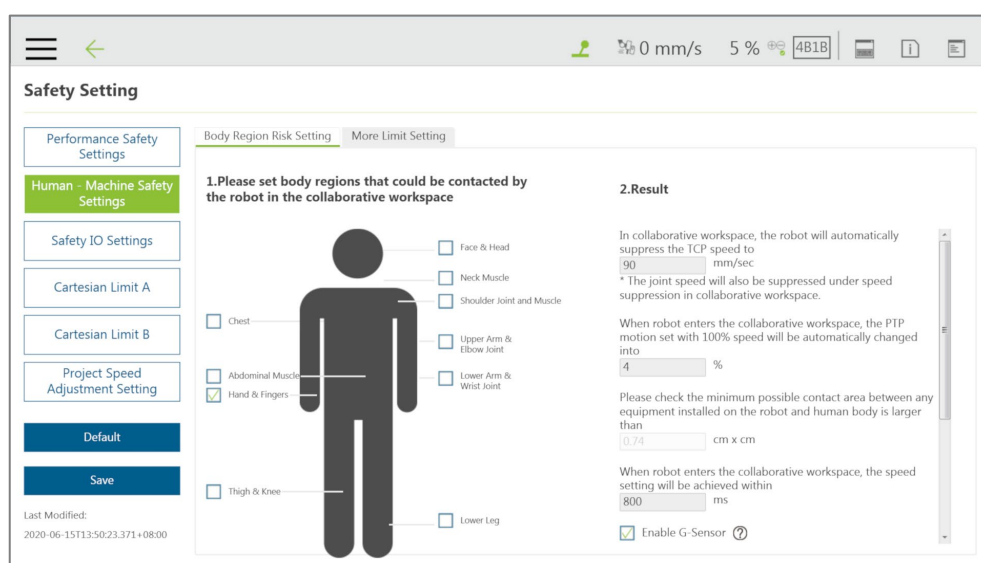

Figure 16: Human – Machine Safety Settings (1/2)

For **Body Region Risk Setting**, users can set the human body region that may be in contact with the robot in collaborative workspace according to the requirements. The calculation result on the right side of this interface displays the robot's running speed in the collaborative workspace. The setting value can be saved after being confirmed by users. The calculation result includes the value of the automatic reduced moving speed, the value of the automatic reduced point-to-point movement speed, and the minimum possible contact area between the robot's external device and human body when entering the collaborative workspace. Users must check the confirmation field in the lower right corner before saving the setting value, to confirm the area where the robot's external device may be in contact with the human body is larger than or equal to the area confirmation value.

This feature is designed for users to quickly set up an initial robot application in collaborative workspace following the biomechanical limits of each body region listed in ISO/TS 15066*. Users should still perform risk assessment on real application before deployment. Users shall take

responsibility for human body region which is not listed in this graph, and ensure the robot does not have any chance to be in contact with any vulnerable body region such as spine and hindbrain.

*Default parameters are recommended based on tests with tool length of 135mm and weight of 0.43kg.



NOTE:

- Users can set the deceleration time manually in the field after **When robot enters the collaborative workspace, the speed setting will be achieved within.**

	TM700/900	TM12/14
Default	150 ms	300 ms
Available range	150~800 ms	300~800 ms

- Check **Enable G-Sensor** to increase the robot's sensitivity to collision detections. This function alone is an auxiliary to increase sensitivity on top of the safety function and not safety rated, and this function works in all mounting poses. Once this function is enabled, the impact force will decrease, and the reduction of stopping time can be negligible. While practicing the risk assessment, users should disable this function.



DANGER:

This function is designed to automatically adjust the speed of robot in the collaborative workspace following the biomechanical limits of each body region listed in ISO/TS 15066. Users should consider more and take responsibility for human body regions not listed separately in the graph by themselves. Also, make sure that the robot does not have any chance to come into contact with any particularly vulnerable body region like spine, neck, or head.



DANGER:

The user connected external safeguard input for Human - Machine safety settings provide users a quick and initial robot application in collaborative workspace following the biomechanical limits of each body region listed in ISO/TS 15066. Though users can further adjust the TCP speed, TCP force, joint speed and the joint torque of robot, users should still perform risk assessment on real application before deployment. Also note that users shall take responsibility for human body region which is not listed in this graph, and ensure the robot does not have any chance to be in contact with any vulnerable body region such as spine and hindbrain.

For setting more detailed parameters, users can go to **More Limit Setting** page.

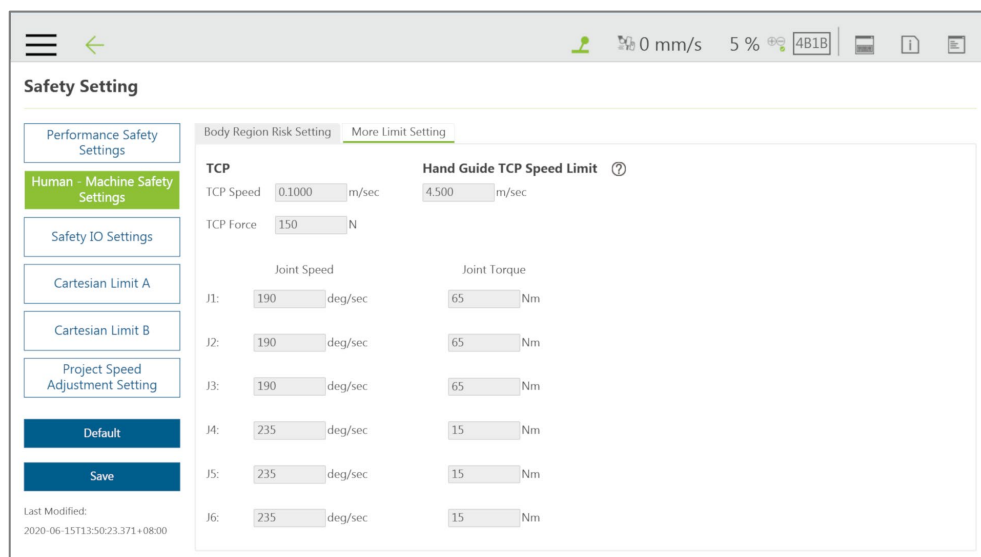

Figure 17: Human – Machine Safety Settings (2/2)

In the **More Limit Setting** page of **Human – Machine Safety Settings**, users can further adjust the TCP speed, TCP force, joint speed and the joint torque of robot. Note that the modified values higher than default values will be highlighted with blue borders, the minimum possible contact area calculation will be removed. In this case, it's user's responsibility and liability to perform risk assessment and validate safety parameters due to the modification. The values can be saved after confirmed by users.

3.3.3 Safety IO Settings

This page is to set up the function of **User Connected External Safeguard** for the TM Robot. For the electrical connection of the **User Connected External Safeguard**, refer to the relevant section of the *Hardware Installation Manual* with the respective hardware version.

Safety IO Settings comes with **User Connected External Safeguard Input Port** and **User Connected External Safeguard Input Port for Human - Machine Safety Settings**. For the definition of each safeguard, refer to the *Safety Manual* for the respective software and hardware version. Note that users should set up this item appropriately according to the risk assessment.

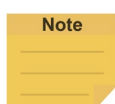

NOTE:

In TMflow Software version 1.74 and earlier versions:

- **User Connected External Safeguard Input Port** is named **Safeguard Port A: Safeguard Pause** or **Safeguard Port Setting Pause**.
- **User Connected External Safeguard Input Port for Human - Machine Safety Settings** is named **Safeguard Port B: Safeguard Collaborative Mode** or **Safeguard Port Setting Collaborative Mode**.
- **Enabling Device Setting** is not available.

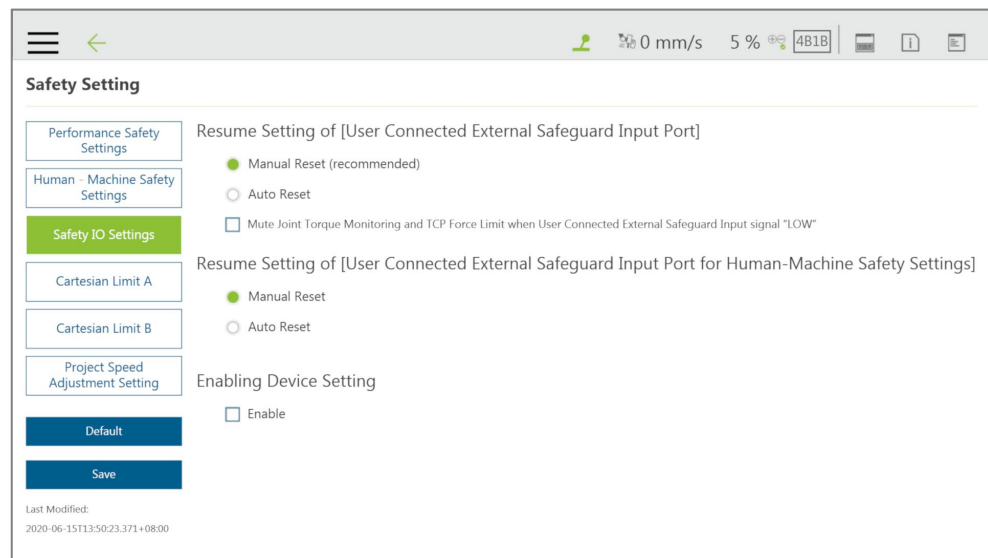

Figure 18: Safety IO Settings

3.3.3.1 Resume Setting of User Connected External Safeguard Input Port

- **Manual Reset (recommended):** For **Manual Reset**, after the robot has been paused through **User Connected External Safeguard Input Port**, even if the trigger condition is removed, users must manually use the **Play/Pause Button** on the **Robot Stick** to release the pause and return to the original project process and project speed.
- **Auto Reset:** For **Auto Reset**, after the robot has been paused through **User Connected External Safeguard Input Port** and once the trigger condition is removed, the robot will automatically release the pause and return to the original project process and project speed.
- **Mute Joint Torque Monitoring and TCP Force Limit when User Connected External Safeguard Input signal “LOW”:** Check this function to deactivate joint torque monitoring and TCP force limit when User Connected External Safeguard Input signal “LOW”.

3.3.3.2 Resume Setting of User Connected External Safeguard Input Port for Human - Machine Safety Settings

- **Manual Reset:** For **Manual Reset**, after the robot has been triggered into **Human – Machine Safety Settings**, even if the triggered condition is removed, users must manually use the **Play/Pause Button** to pause the robot motion and press the **Play/Pause Button** again from the **Robot Stick** to return to the original project process and project speed.
- **Auto Reset (by default for HW 3.0 or earlier):** For **Auto Reset**, after the robot has been triggered into **Human – Machine Safety Settings**, and once the triggered condition is

removed, the robot will automatically return to the original project process and project speed.

3.3.3.3 Safeguard Port Setting for the Hardware Version prior to 2.00 (inclusive)

The former section refers to the setting of hardware version 3.2. The **Safeguard Port** of hardware version 2.00 has the functions of switching to pause and triggering the **Collaborative Mode**. For the connection and use, refer to the corresponding hardware version of the *Hardware Installation Manual*. Users shall set up this item appropriately according to the risk assessment.

- **Pause:** The **Safeguard Port** will trigger pause. The following settings will set up the **Safeguard Port** to reset mechanism during the pause.
- **Manual Reset (recommended):** When you choose **Manual Reset**, after the robot is paused through **Safeguard Port**, even if the trigger condition is removed, users can only operate the **Play/Pause Button** or the same action from the **Robot Stick** to release pause and return to the original project process and project speed.
- **Auto Reset:** When you choose **Auto Reset**, after the robot paused through **Safeguard Port**. Once the trigger condition is removed, the robot will automatically return to the original project process and project speed.
- **Collaborative Mode: Safeguard Port** will trigger the **Collaborative Mode**. Once the trigger condition is removed, the robot will automatically return to the original project process and project speed.

3.3.3.4 Enabling Device Setting (HW 3.2 or newer exclusive)

Enabling Device provides the dual channel input ports for users to connect to a three-position enabling device. Check to box to apply the setting. Note that the status of this safety setting will not affect the operation in Auto Mode. When this setting is enabled and connected to the enabling switch, in Manual Mode, all manual control operations are enabled only when users press the three position enabling device in the middle position. If the Enabling Device is released or fully pressed, the robot performs a protective stop. When starting a manual trial run of the project pressing the PLAY button, the Enabling Device should be pressed in the middle position. When Enabling Device is released or fully pressed during the Manual Trial Run mode, the Project Speed will always automatically return to 5%. Connect this function only to the three-position enabling device compliant with IEC60204-1. Note that the input of this function has two input statuses only, so the Enabling Device should not have an enabled output during the procedure from the fully pressed status to the fully released status.

3.3.4 Cartesian Limit A & B

For users of HW 3.2 or newer, Cartesian Limit A & B are available as a cube or a cylinder with Operation Space disabled to set the bounds for the robot movement. Any violation to the safety plane from TCP and/or elbow limits of position will result in a Cat.2 stop for Cartesian Limit A and trigger Human-Machine Safety Setting in Cartesian Limit B.

To use Cartesian Limit A or B, follow the steps below.

1. Navigate to  and click **Setting > Safety > Cartesian Limit A or B**.
2. Check **Enable Cartesian Limit & Disable Operation Space** and check **TCP** or **elbow** for **Limits of position**.
3. Select from **Cube** or **Cylinder** in **Cartesian Setting**.
 - For **Cube**, proceed to check the desired axes bounds, and, in the next fields, input the integer values of the desired distance in millimeters. Be sure to make the difference between the upper bound and the lower bound larger than 120 in millimeters.
 - For **Cylinder**, proceed to check the desired axis bounds or **R** for the radius, and, in the next fields, input the integer values of the desired distance in millimeters. Be sure to make the difference between the upper bound and the lower bound larger than 120 in millimeters.

Note

NOTE:

For robots set with Cartesian Limits, it is not possible to run a project with an Operation Space.

3.3.5 Project Speed Adjustment Setting

Project Speed Adjustment Setting is available to users to adjust or restrict motion speed during project executions for safety and security.

To use Project Speed Adjustment Setting, follow the steps below.

1. Navigate to  and click **Setting > Safety > Project Speed Adjustment Setting**.
2. Check **Enable Manual Trial Run Mode Speed Adjustment** to set the project running with a flexible speed or uncheck to fix to 5% speed in Manual Trial Run Mode.
3. Check **Enable Auto Mode Speed Adjustment** to let users adjust speed in project executions under Auto Mode. Once checked, it is recommended for users to set the speed adjustment password immediately. The password is blank by default. When the password is set, click the **Reset Password** button to set the password again.

4. Click **Save** to keep the setting or **Default** to restore the defaults.

As users check either item in Project Speed Adjustment Setting, the speed adjustment icon with a stop sign turns to a tick sign appearing between the speed indicator and the Safety Checksum icon, and users can learn from the speed adjustment icon to know if it is available to adjust speed in the current mode.

3.3.6 Switch between Modes

Switching between Auto mode and Manual mode is prohibited/rejected by the system under these conditions:

1. The project is running in Auto Mode.
2. The project is running in Manual High Speed Mode.
3. The robot is in Hand Guide Mode.
4. SF15 Enabling Device is triggered (Enabling Device is continuously held in middle position) in Manual Mode.
5. A Cat. 0 or Cat. 1 stop is in effect.

To switch from Auto Mode to Manual Mode, first press the Stop Button to stop robot operation if the project is running. Once the project is stopped, press the Mode Switch Button on the robot Stick and the operation mode will be switched to Manual Mode.

To switch from Manual Mode to Auto Mode, press and hold the Mode Switch Button for a few seconds. Once the Mode Indicators on the Robot Stick start blinking, press the +/- buttons on the **Robot Stick** in this order: "+ - + + -" to change to Auto mode. Go to the pages of **View, Run Setting**, or **Connect** to press and hold the **M/A Mode Button** and press the +/- buttons on the **Robot Stick** in this order: "+ - + + -" to change to Auto mode. The robot will stay still in Auto mode until you press the play button on the robot stick.

When the robot performs trial run in **Manual Mode** again, the project speed will start with the initial speed at 5%. Refer to 4.4 Build and Run Your First Project for how to set the project speed.



DANGER:

Prior to selecting automatic operation, any suspended safeguards must be set back to full functionality.

Note

NOTE:

- To lock the robot stick in either Auto mode or Manual mode, press and hold the + Button and the – Button at the same time until either the blue LED or the green LED blinks, and then press the +/- Button in the sequence of "-", "+, -, -, +". The robot stick is now locked in the respective mode, and the system beeps when any button is pressed on the locked robot stick.
- To unlock the robot stick in either Auto mode or Manual mode, press and hold the + Button and the – Button at the same time until either the blue LED or the green LED blinks, and then press the +/- Button in the sequence of "-", "+, -, -, +". The robot stick is now unlocked in the respective mode.
- Users can press and hold the power button on the robot stick to shut down the system.

4. Start Your First Project

4.1 Overview

This chapter will describe how to create and run your first project. Only after users have read all instructions and have a full understanding of the content of this manual and have correctly set the TM Robots according to the contents of Chapters 2 and 3, can procedures in this chapter be performed.



IMPORTANT:

Before starting the very first project, confirm that the **User Connected External Safeguard Input Port for Human-Machine Safety Settings** is OPEN and the robot is in the **Human – Machine Safety Settings** state as the **Indication Light Ring** of the **End Module** is flashing purple. Refer to the section of Safety Connection in corresponding hardware version of the *Hardware Installation Manual* for details.

4.2 Initial Setting

When your device is connected to the TM robot for the first time, follow the wizard steps to complete the following settings:

- Step 1.** Follow the steps to set up the robot.
- Step 2.** Select the interface language.
- Step 3.** Set the system time.
- Step 4.** Set the Network settings.
- Step 5.** Perform voice settings.

Navigate to , and click **Setting > Wizard** to reset if required.

4.3 M/A Mode and FreeBot

Confirm the **Operation Mode** of the robot at this time. Check the mode Indicator on the **Robot Stick**, and identify whether the lamp position is marked as **MANUAL** (Manual Mode) or **AUTO** (Auto Mode). The mode can also be identified by the **Indication Light Ring** of the **End Module**, where green light is **Manual Mode**, and the blue light is **Auto Mode**. If it is still in **Auto Mode**, press the **M/A Mode Switch Button** on the **Robot Stick** to switch to the **Manual Mode** to perform the follow-up operations of this chapter. When the indicator of the **M/A Mode Switch Button** is green and the **Indication Light Ring** of the **End Module** is green, it is in **Manual Mode**.

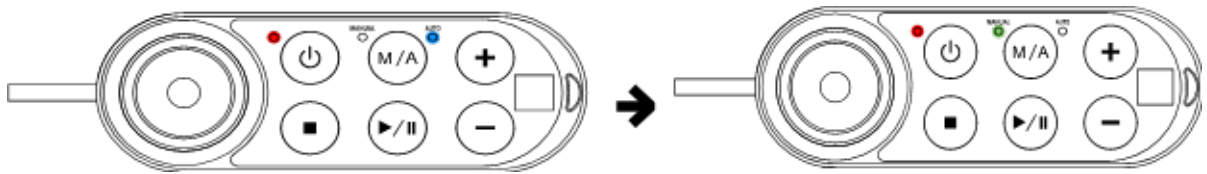

Figure 19: Auto Mode / Manual Mode (1/3)

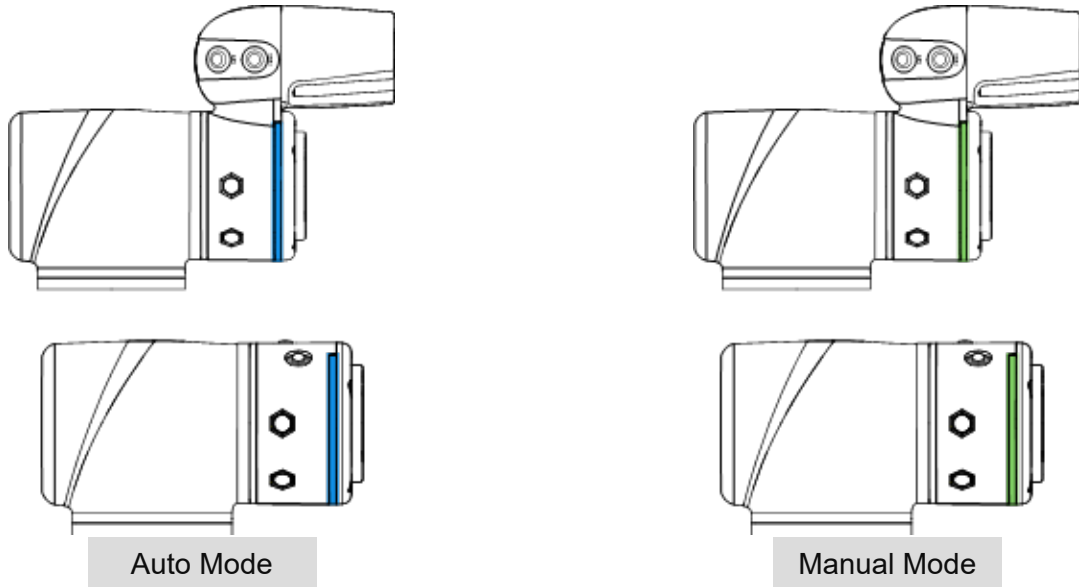

Figure 20: Auto Mode / Manual Mode (2/3)

In **Manual Mode**, press the **FREE Button** to hand guide the robot. The hand guiding function is limited to **Manual Mode**.

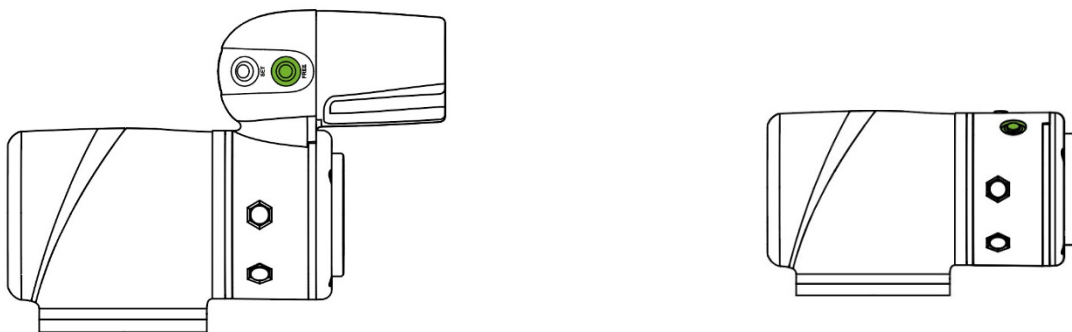

Figure 21: Auto Mode / Manual Mode (3/3)



NOTE:

For users of HW 3.2 or newer, the robot stick comes with the speed indication LEDs as shown below.

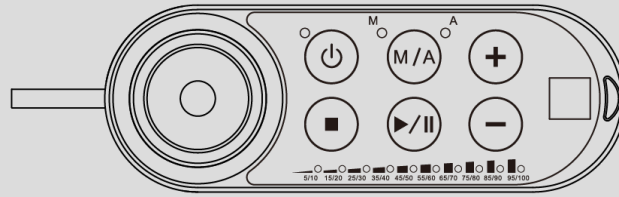

Figure 22: The Robot Stick for HW 3.2 or newer

4.4 Build and Run Your First Project

If this is the first time you are unpacking the TM Robot, there will be no project in the robot. You can build your first project according to the instructions of this section. The following project target is to run back and forth between two points (P1 and P2). The setting method is as follows:



DANGER:

Only after users have read all instructions first and have a full understanding of the content of this manual and have correctly set the TM Robot according to the contents of Chapters 2 and 3, can procedures in of this chapter be performed.

- Step 1.** Confirm the **Operation Mode** of the robot. If it is not in **Manual Mode**, press **M/A Mode Button** to switch to **Manual Mode**.
- Step 2.** Navigate to , and click **Project** to enter the **Project Editing Page**.
- Step 3.** Choose to create a new project and enter the project name.



IMPORTANT:

- The project naming supports Latin alphabet in upper case and lower case (A-Z, a-z), numbers (0-9), and the character “_”.
- Do not use reserved words such as var in naming.

- Step 4.** Enter the project name. The maximum number of characters for naming a project is 100.
- Step 5.** Press the **FREE Button** to move the robot to any point by hand guiding and press the **POINT Button** to let the project flow generate the point. You can see that the robot automatically names this point as P1 and has been automatically added after the Start Node and automatically highlighted.

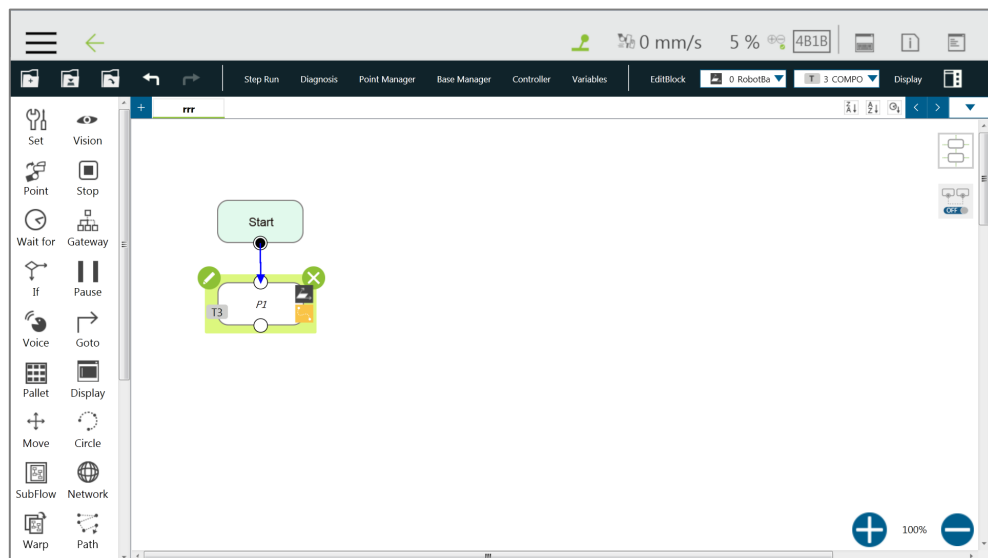

Figure 23: Build and Run Your First Project (1/5)

- Step 6.** Press the **FREE Button** and move the robot to any other point by hand guiding. Press the **POINT Button** to record this point and generate P2.
- Step 7.** Drag a **Goto Node** from the nodes menu onto the project flow.
- Step 8.** Click the pencil icon and click on **Set Goto Target**. Choose P1.
- Step 9.** Press the save icon to complete the project editing.
- Step 10.** Press the **Play/Pause Button** on the **Robot Stick** in the **Project Editing Page** to start running the project. At this time, the **Indication Light Ring** will flash in green. Each time you start running a project in **Manual Mode**, the **Robot Stick** looks as shown.

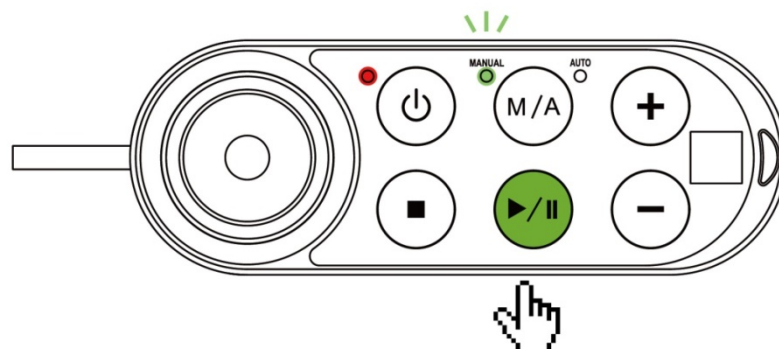

Figure 24: Build and Run Your First Project (2/5)

- Step 11.** In the trial run, the process speed of the project will start at initial speed of 5% as shown on the top right of the **Project Editing Page**.
- Step 12.** Press the **+ button** (increase running speed) / **- button** (decrease running speed) on the **Robot Stick**, to increase or decrease the project speed of the robot. Adjust the speed of

the robot at this time for an appropriate speed. (You can read the set project speed from the % number displayed at the top right of the operation interface.)

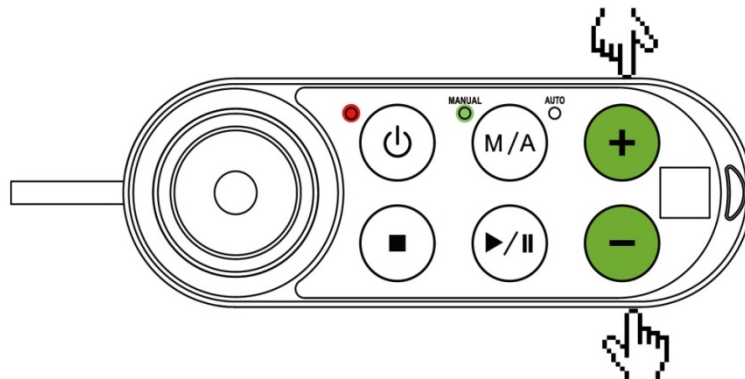

Figure 25: Build and Run Your First Project (3/5)

- Step 13.** After setting your preferred project speed, press and hold the **M/A Mode Button** to store the project speed. If ended and stopped without any error, the project will be labeled **Tested**.
- Step 14.** Press the **Stop Button** on the **Robot Stick**, and go to the **Run Setting** page to check your current project file labeled **Tested**. You can also go to the pages of **View**, **Run Setting**, or **Connect** to press and hold the **M/A Mode Button** and press the +/- buttons on the **Robot Stick** in this order: "+ - + + -" to change to Auto mode. The robot will stay still in **Auto Mode** until you press the play button on the robot stick. Remember that if you perform a trial run in **Manual Mode** again, the project speed will start with the initial speed at 5%. You must perform the previous steps again to set the project speed.
- Step 15.** Press the **Play/Pause Button** in **Auto Mode**.
The speed remains at the project running speed you set, and the speed cannot be changed in **Auto Mode**.

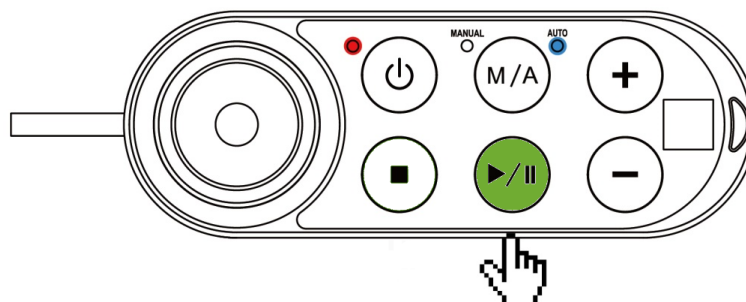

Figure 26: Build and Run Your First Project (4/5)

- Step 16.** Congratulations on your successful completion of project editing and running. Press the **Stop Button** on the **Robot Stick** to stop running the project.

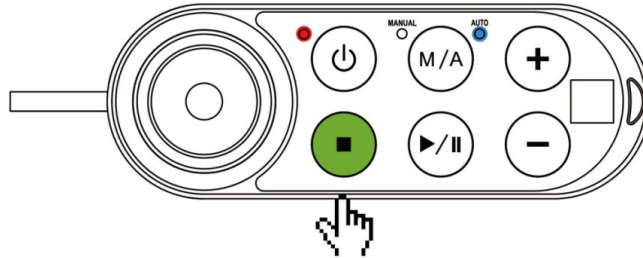

Figure 27: Build and Run Your First Project (5/5)

- Step 17.** Switch over to **Manual Mode**.
After stopped the project, you can press the M/A button on the Robot Stick to switch over to **Manual Mode**.



WARNING:

Running the self-constructing project before completing adequate training may lead to body collision or human injuries due to the unforeseen robot actions.

4.5 Shutdown

There are two shutdown methods:

- Method 1:** In **TMflow**, navigate to , click **Shutdown**, and choose **Shutdown**. When the warning message appears, click **OK** to shut the system down properly.
- Method 2:** Press and hold the power button of the **Robot Stick**, and release the button when you hear a beep sound. The power indicator of the **Robot Stick** is flashing in red and the robot performs shutdown.

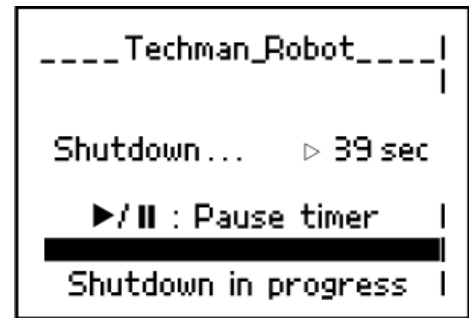
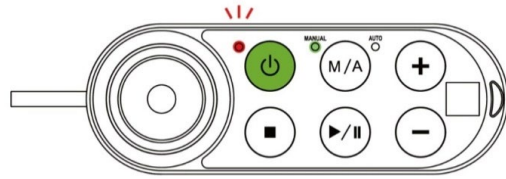

Figure 28: Shutdown



DANGER:

The following Shutdown methods are prohibited:

1. Unplugging the power plug directly
2. Loosening the power cord of **Control Box** directly
3. Loosening the power of robot body directly

5. Operation Interface

5.1 Overview

The chapter will introduce the operation interface of **TMflow**, including the icons in the function menu: **Login/Logout**, **Connect**, **View**, **Run Setting**, **Project**, **Setting**, and **System**.

Navigate to ☰ and click to expand the function menu. The listed icons from top to bottom are:

- **Login/Logout**: login/logout to start/stop using the robot
- **Connect**: list the available robots
- **View**: display page when the project is running
- **Run Setting**: project list and the default project to run
- **Project**: create or edit the project
- **Setting**: the robot setting
- **System**: the system setting
- **Shutdown**: turn off the system

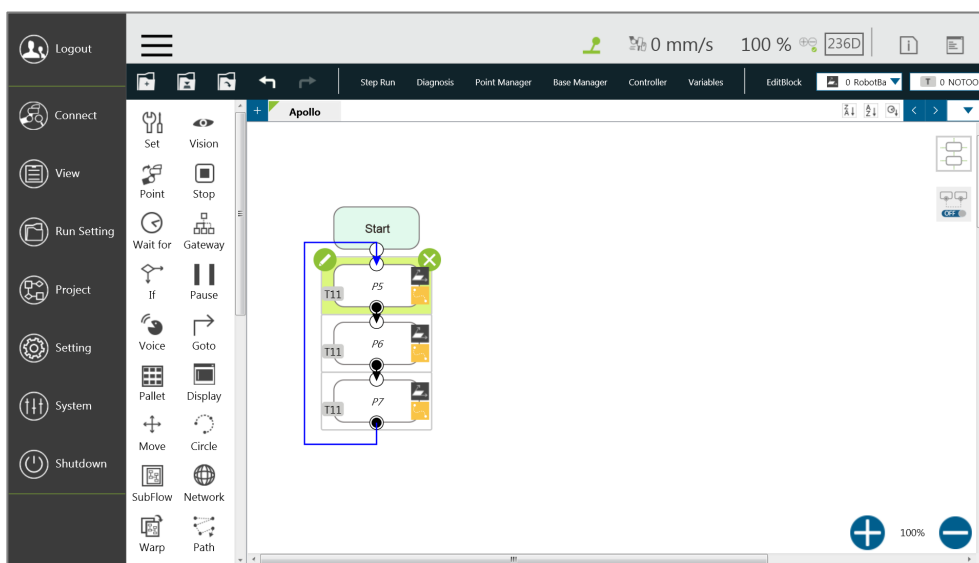

Figure 29: Function Menu

Note

NOTE:

- When connected from a client device, there is another icon, **Leave**.
- The selection is available when the mouse cursor moves onto the immediate vicinity of the icon or the text in the function menu.

5.2 Login/Logout

The login window will pop up when clicking **Login**. Enter your account number and password to start using the robot.



CAUTION:

The default account is **administrator**, and the default password is blank.

Refer to Chapter 2 for details, from start up to complete login: Start up and Activation.

5.3 Connection

5.3.1 Local Connection

To control the robot with the screen, keyboard and mouse via the **Control Box**, follow the instructions below to log in and connect. After completing login, click **Get Control** as shown below to control the robot. To release the control to the robot, click **Release Control**. Refer to Chapter 2 for the details.

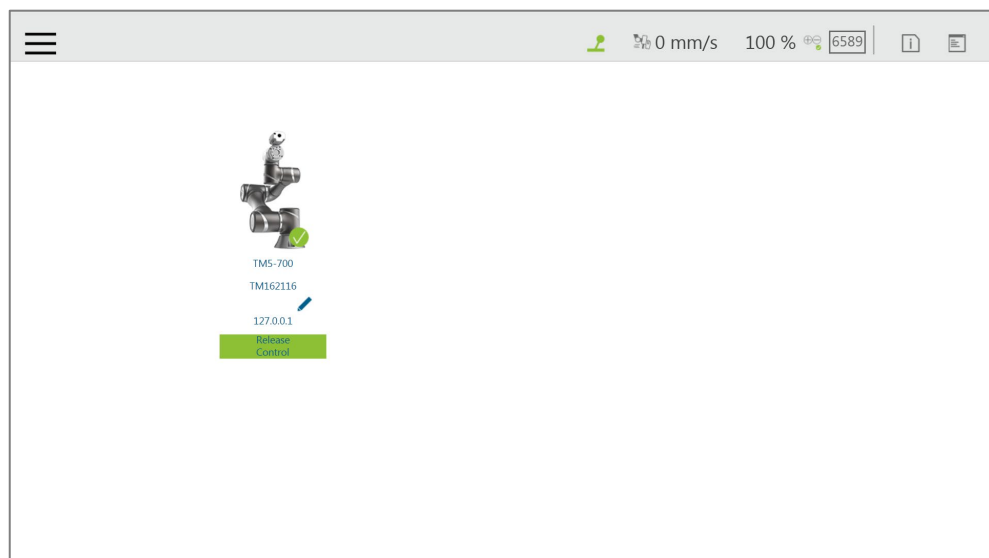



Figure 30: Get/Release Control (Local)

5.3.2 Remote Connection

To control the robot from a remote device (desktop, laptop, or tablet), follow the instructions below before login. Click the upper left corner  to refresh the robot list. Available robots will be displayed with their images, models, IDs, Nicknames, IP addresses, and occupancy in the list. Double-click the available robot to bring up the Login pop-up window and allow for login. Click the **Get Control** button below the robot to get control. To release the control, click **Release Control** again. Refer to Chapter 2 for details. A warning message will prompt users to use the same version of TMflow for connection if the versions between the client and the host are different.

Note

NOTE:

The addresses of **Modbus Slave** and **Ethernet Slave** for robot stick commands (Play/Pause, +, -, Stop) cannot be written to when the robot is in Manual Mode or when users get control permission in Auto Mode.

5.4 View

In the view page, users can monitor project progress and the robot, as the figures below from left to right are **Display Board**, **IO**, **Simulator**, **Status**, **Force Sensor**, and **Vision Viewer**.

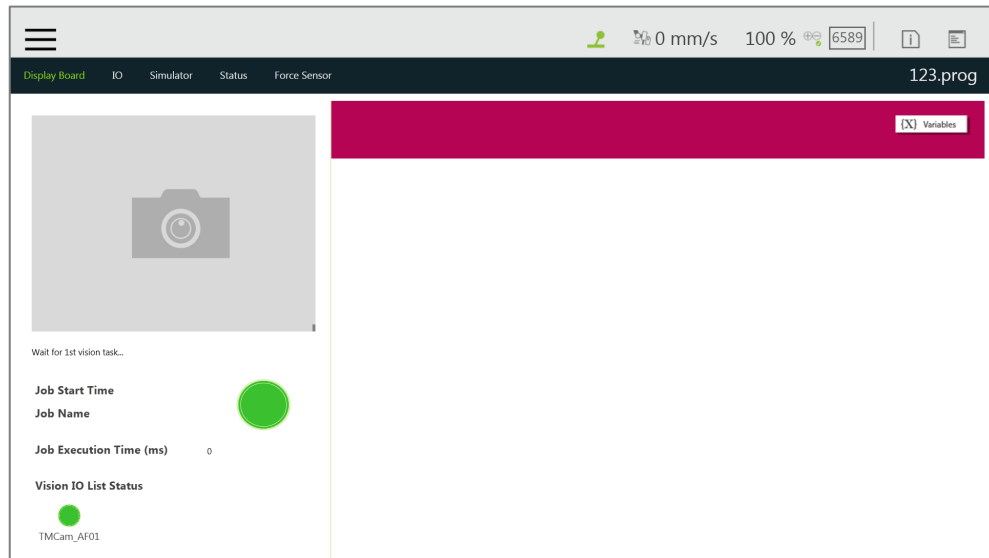

Figure 31: View



IMPORTANT:

The robot provides remote and local multi-logins, but only one person can get control at a time.

5.4.1 Display Board

In **Display Board**, users can monitor the project running status such as the vision job result at left and the status display at right. The status display contains both descriptions and variables that can be switched by **{X} Variables** and **Description** buttons on the upper right corner. The description content can be changed through the **Display** node, and the variable can be changed through the **Display Management** in the project.

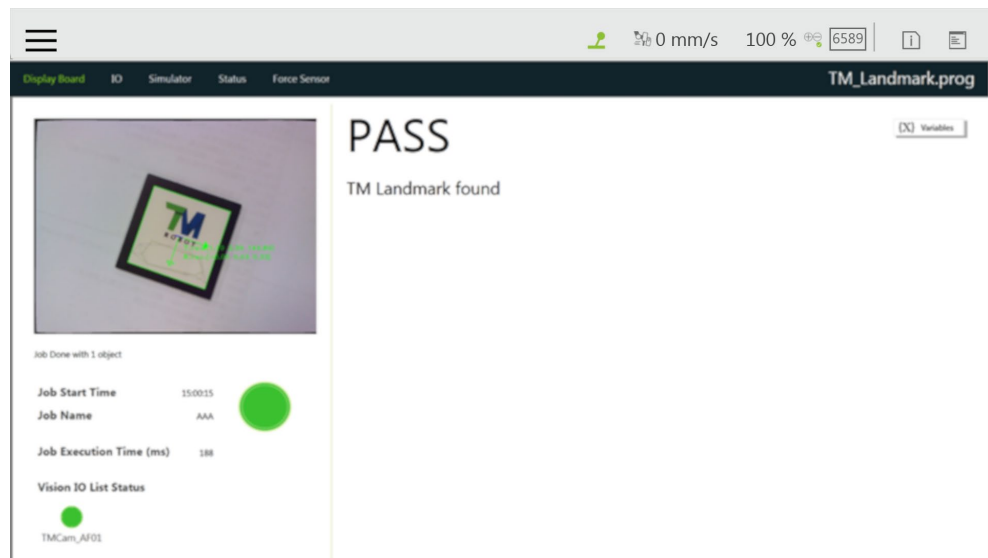

Figure 32: Display

Note

NOTE:

When an error occurred:

- In Manual mode
 1. The system will return to the **Project Editing Page**, highlight the node induced the error, and expand the system log with the error code.
 2. If there is no account currently logged in or the logged in account does not come with the privilege to open the project, the system will not return to the **Project Editing Page** but expand the system log with the error code.
 3. The contents in the Display Board does not go away even if users go back the **Project Editing Page** until the project runs again.
 4. The system log does not fold up automatically.
- In Auto mode
 1. The system log expanded at right and the once grayed out **Flow** button turned on the top left.
 2. Users can click **Flow** to generate the project flow with the node induced the error highlighted. If the flow did not induce the error, the highlight is on the last executed node.
 3. The system displays the page induced the error only and highlights the node induced the error.
 4. Users can switch to Manual mode to correct the node induced the error with the function menu or press the play button of the robot stick without correcting to make the **Flow** button gray out and the system log fold up automatically.

5.4.2 Flow

In **Manual Mode**, the flow will be displayed with the focus on the current processing node while the project is running. Switch off the Auto Focus-Tracking icon at top right to scale the flow with the + and the - button at bottom right. Through this page, users can conveniently monitor the

process as well as properly optimize and modify the process. In **Auto Mode**, this page will not display.

5.4.3 IO

IO provides IO status monitoring and operation tools for users to monitor the status of the digital/analog input and to operate the digital/analog outputs in this page. When the project is running, the IO is controlled by the project and cannot be changed manually.

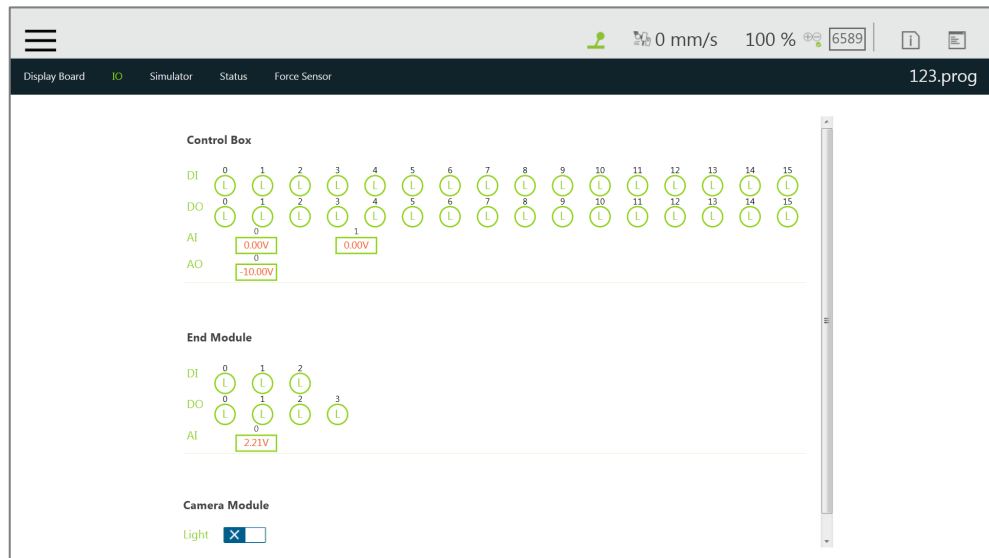

Figure 33: IO

5.4.4 Simulator

In Simulator, users can monitor the current robot posture. Press and hold Ctrl on the keyboard and, with the right button of the mouse depressed, rotate the 3D model by dragging the mouse. Press and hold Ctrl and, with the left button of the mouse depressed, zoom in and out of the 3D model by dragging the mouse up or down. Press and hold Ctrl and, with the middle button depressed, move the 3D model by dragging the mouse. The information of the Joint Angle and TCP Coordinate status of Robot base is at the right.

Note

NOTE:

If your mouse comes with a scroll wheel, it is the middle button. If your mouse does not come with a scroll wheel or a middle button, you can press the left and the right buttons simultaneously to function as the middle button.

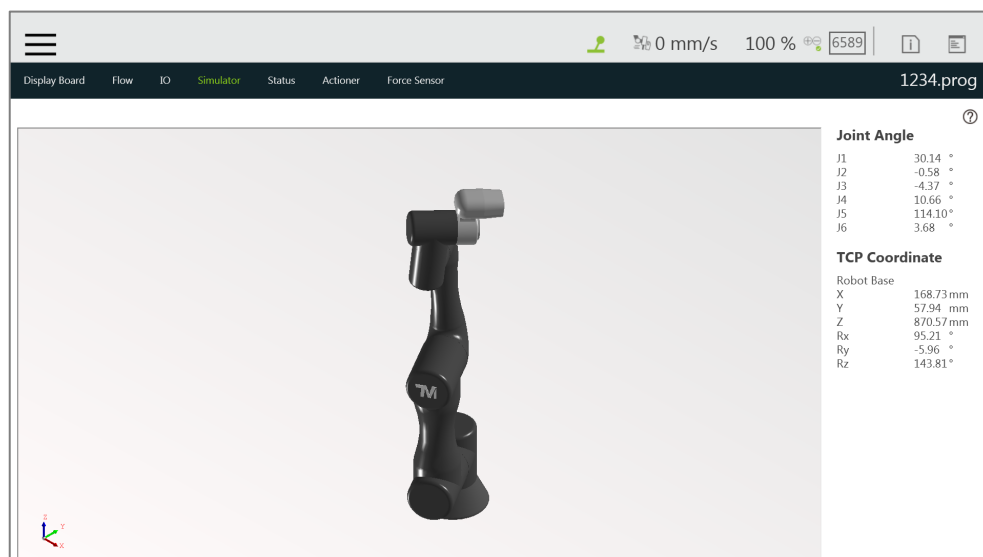

Figure 34: Simulator

5.4.5 Status

In **Status**, **Controller Temperature**, **Robot Voltage**, **Robot Power Consumption**, **Robot Current**, **Control Box I/O Current**, and **Tool Side I/O Current** can be monitored. The currently running project or preset project will be displayed on the upper right corner.

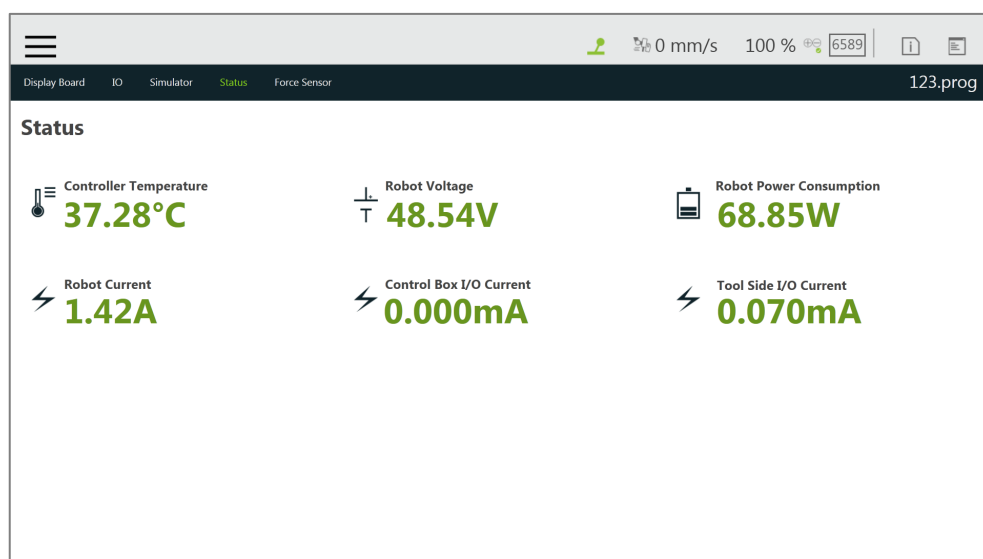

Figure 35: Status

5.4.6 Vision Viewer

In **Vision Viewer**, users can check results, images, and variables ended up with the vision job. While the project is running, this page stays at which the current vision job finished and keeps updating, and users can pause the project and check with the finished vision job in the meanwhile. When the project is stopped, information of the vision job and images remain in **Vision Viewer**

until the next project execution. **Vision Viewer** is available in Manual Mode, Auto Mode, and TMflow client.

The resolution in the **Vision Viewer Live Video** is 640*480. If the system comes with the external SSD, users can use the magnifier to enlarge the selected region on the **Live Video** for 1, 2, or 4 times. The magnifier is not available if no external SSD is presented or no image in the external SSD.

Note

NOTE:

- If the variable outputs more than the available length in **Vision Viewer**, users can move the cursor on the variable and the system will prompt its entire content.
- Use the slider for the outputs beyond the available viewing area.

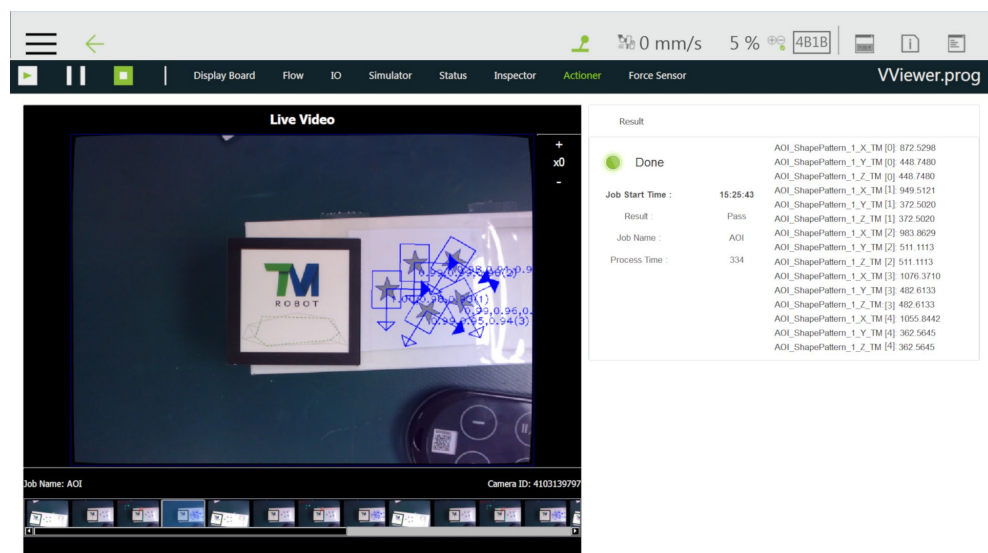

Figure 36: Vision Viewer

The finished vision jobs will append to the right as thumbnails in the list below **Live Video**. When the project is paused or stopped, click on the thumbnail will highlight the thumbnail and the job name and the camera type will show above the list. Double-click on the thumbnail to view the respective vision job. Use the left arrow on the list to go back.

5.5 Run Setting

In **Run Setting**, all executable projects can be viewed. For instance, Current displayed on the file represents this project is running currently, Tested displayed represents this project can be run in **Auto Mode**. If the project is to be run in **Auto Mode**, it must go through the **Trial Run** process. The running method of **Trial Run** is performed in **Manual Mode**. After adjusting the speed, while the project is running, press and hold the **M/A Mode Button** and press the +/- buttons on the **Robot Stick** in this

order: "+ - + + -" to change to **Auto Mode** and complete the project with complete **Trial Run** procedure and ensure the safety while running. The robot will stay still in Auto mode until you press the play button on the robot stick. Remember that if you perform trial run in **Manual Mode** again, the project speed will start with the initial speed at 5%.



Figure 37: Single Project Icon

5.6 Project

Navigate to and click **Project** to start creating and editing the flow. As shown in the figure below, the top is the **Project Editing Toolbar**, and the left is the node menu, the right sidebar contains system log and system function menu. Move the mouse cursor on the icon to read its function on the ribbon. show At the top right, icons at the right of the item separator line can be clicked for more information by clicking to expand the system log folded at the right and to check the **TMflow** version. Icons at the left of the item separator line are for indications only such as suggests your device occupied the robot, no one occupied the robot, and someone occupied the robot. The number comes with mm/s suggests the TCP speed, and the percentage suggests the project speed. For HW 3.2 users, the robot stick comes with the color LED speed meter, and the speed meter syncs with the project speed of TMflow.



NOTE:

- There would be some buffer/deviation between the number suggested as the TCP speed and the value calculated from safety monitoring function. The suggested number as the TCP speed is for reference only.
- The number suggested as the TCP speed renews approximately every 1 second.

While editing the project, users can click to expand the system function menu folded at the right, and click to redo or click to undo changes of adding normal nodes, duplicating normal nodes, or deleting normal nodes up to 5 steps.



NOTE:

The 5 steps of redo or undo changes do not apply to adding, duplicating, and deleting of the **Component**, the **Subflow**, and the **Thread** as well as normal nodes that disappear due to the operations of the **Component**, the **Subflow**, and the **Thread**.

Hot Key	Function	Hot Key	Function	Hot Key	Function	Hot Key	Function
Ctrl shift P	Play/Pause	Esc	X, escape	Ctrl Z	Undo	F1	Step run
Ctrl shift M	M/A	Enter	OK	Ctrl Y	Redo	F2	Diagnosis
Ctrl shift [-	Ctrl N	New project	Ctrl C	Copy	F3	Point Manager
Ctrl shift]	+	Ctrl S	Save project	Ctrl V	Paste	F4	Base Manager
Ctrl shift 9	Info	Ctrl O	Open project	Delete	Delete	F5	Controller
Ctrl shift E	Error Log					F6	Variables

Table 4: Keyboard Hot Keys in TMflow

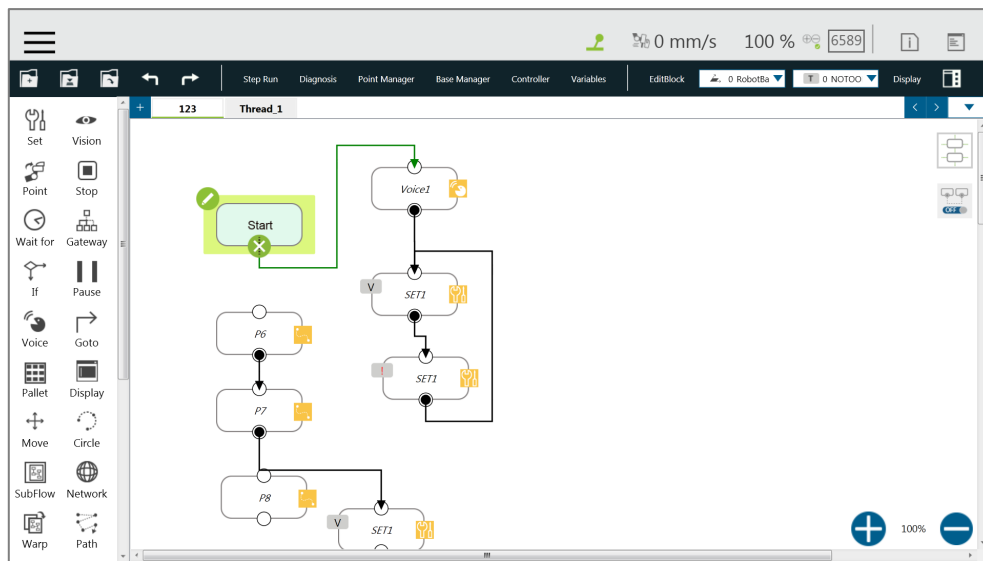



Figure 38: Project Editing Page

5.6.1 Project Editing Toolbar

The project editing toolbar is located at the top of the **Project Editing Page**. From left to right the functions are **Create New Project**, **Save Project**, **Open Project**, **Step Run**, **Diagnosis**, **Point Manager**, **Base Manager**, **Controller**, **Variables**, **EditBlock**, **Current Base and Base List**, **Current Tool and Tool List**, and **Display Manager**.

5.6.1.1 Create New Project

Click  to create a new project. The project naming supports Latin alphabet letters in upper case and lower case (A-Z, a-z), digits (0-9), and the character '_'. The maximum number of characters can be used in naming a project is 100.

Note

NOTE:

- Check **Component Editor** to create components. Refer to 16 TM Component Editor for details.
- Check **Conveyor Tracking** to create projects for conveyor tracking. Refer to *TM Conveyor Tracking User Manual* for details.

IMPORTANT

IMPORTANT:

- When saving the file, if there is a file with the same filename, it will be overwritten. Save the file with care to avoid file loss.

5.6.1.2 Save Project

Click  to save the project. The project naming supports Latin alphabet letters in upper case and lower case (A-Z, a-z), digits (0-9), and the character '_'. The project is saved with the date and the time of build and last updated. If the previous project is not closed properly, a message will prompt when the project is opened. If select **Yes**, the last saved file version will be opened and all subsequent modifications will be discarded. If select **No**, the file will open with the last state before closing, and for users to perform the file saving operation.

Note

NOTE:

A warning message will prompt users to save the current project if unsaved. Click **Yes** to save and close the project, **No** to simply close the project, or **Cancel** to ignore the message.

5.6.1.3 Open Project

Click  to open existing projects. Projects are listed with the build date and the modified date. Users can sort projects in the list with the buttons of reverse alphabetical, alphabetical, or chronological. Click the **Batch Delete** button to select multiple projects to delete. Click on the name of the project to select the project to delete. Repeat the step if there are more projects to delete or check the box next to **Select all** to select all projects, and click **Delete** button to delete the projects. Click the left arrow icon on the top left to exit.

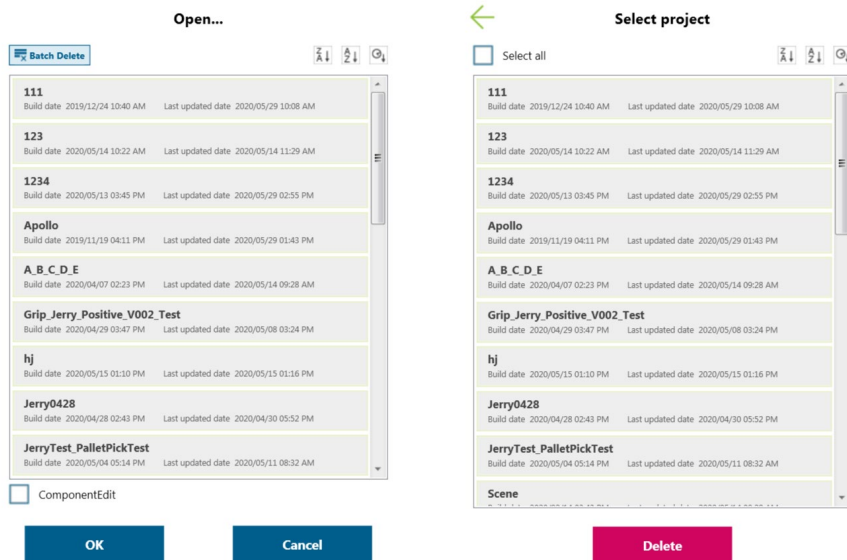

Figure 39: Open and Delete Project View



IMPORTANT:

The currently opened project cannot be deleted and deleted projects cannot be restored.

5.6.1.4 Step Run

Step Run is used to confirm accuracy of the edited motion. The first node of a Step Run can be a Start, a Point Node, or any node that is not grayed out. This allows users to easily evaluate the correctness of the node/motion. **Step Run** can start running from the selected node to have the robot moving by pressing and holding **Run** on the screen or the + button on the **Robot Stick**. At any time, releasing **Run** on the screen or the + button on the **Robot Stick** will stop the robot movement, and pressing and holding **Run** on the screen or the + button on the **Robot Stick** again will start the robot moving from where it stopped. When the **Step Run** pane displays **(Node name)_finish**, the node running is completed. Release **Run** on the screen or the + button on the **Robot Stick** and press and hold again to continue to the next node. If the **Step Run** window is open, the **FREE** button at the **End Module** cannot be used to hand guide the robot. Also, both the variable system and the decision formula will not operate. When there is a logical branch node (e.g., If Node, Gateway Node) the path of pass or fail can be selected freely to check that each decision branch's internal motion programming is correct using **Step Run**.

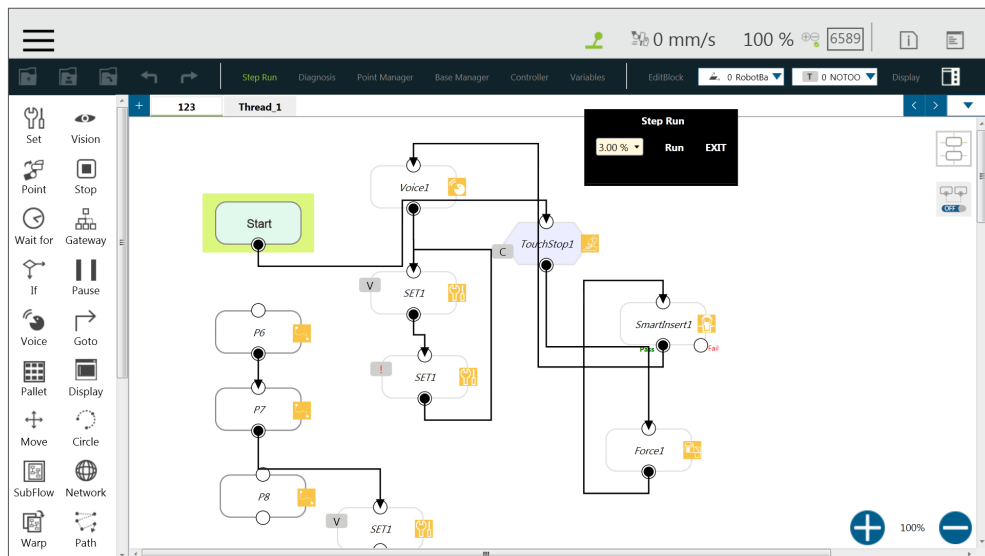





Figure 40: Step Run



IMPORTANT:

When using **Step Run** through a **Subflow** node, click **RUN** to enter the **Subflow** page, or click another node to skip the **Subflow** steps. Although the variable system will not operate, the **Vision** node will run. The **Vision** node parameter value and output value can be refreshed through a **Step Run Vision** node to facilitate subsequent programming and fine tuning. Since the variable system will not work, the **Pallet** node will only run for the first point.

5.6.1.5 Point Manager

Point Manager lists all points and their parameters including the category of points: **General point, fine-tuning point, dynamic point**, the reference **Base** to which the point is attached, and the tools used by the point. For the creation and applicable nodes of all categories of points, refer to the Point node, F-Point node, and Touch Stop node. In the **Point Manager**,  represents **Vision Base**, and  represents **Custom Base**. Click the  on the right side of the point to go to the information page of the point where users can modify the point name and find out the reference coordinates, tools, and detail coordinates of the point: [X, Y, Z, Rx, Ry, Rz]. Users can set the type of motion with either **PTP** or **Line** and its speed at the bottom.

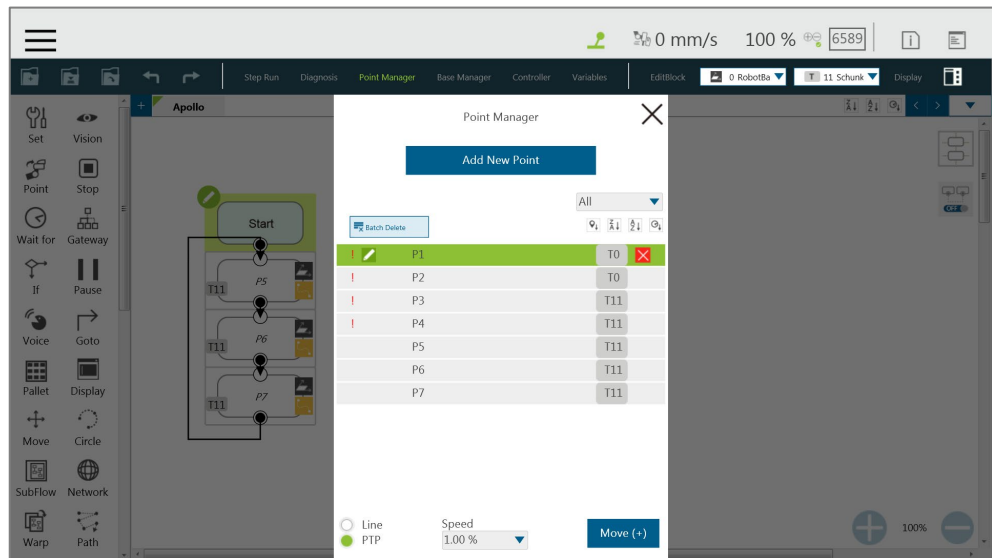

Figure 41: Point Manager (1/2)

Users can use dropdown to filter available point in the list, and sort points in the list with the buttons of point order, reverse alphabetical, alphabetical, or chronological. Click the **Batch Delete** button to select multiple points to delete. Click the pencil icon to point modification.

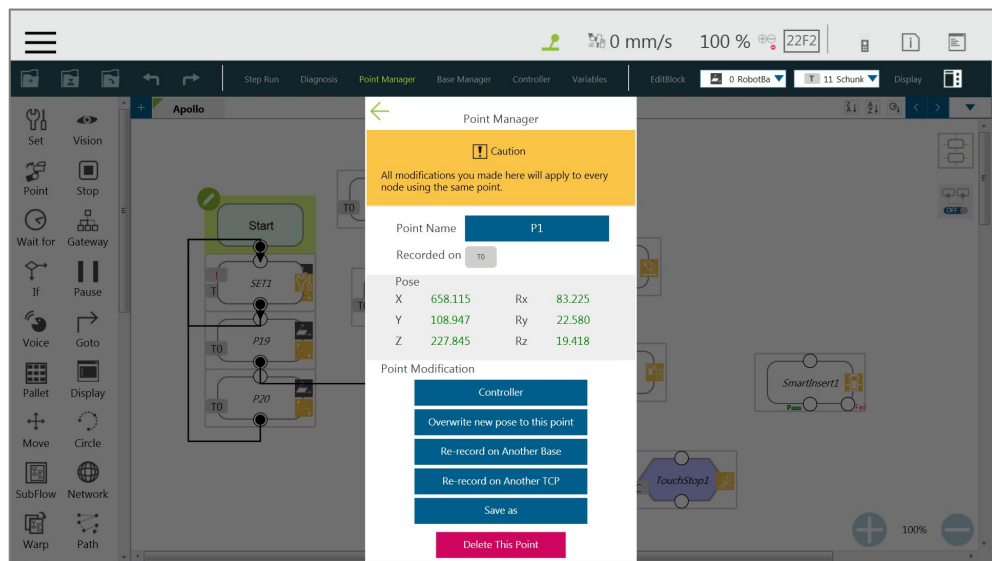

Figure 42: Point Manager (2/2)

- **Controller:** Enable the Controller to operate robot.
- **Overwrite new pose to this point:** Write the current robot position and posture at this point and overwrite the original value.
- **Re-record on Another Base:** Re-record this point on another **Base**, change the reference coordinate.
- **Re-record on Another TCP:** Re-record another tool for the point when users want to

run the same position with a different tool. After selecting TCP, users can select **Keep Pose** to hold the flange position and transfer the TCP position or **Keep Path** to transfer the flange position and hold the point position. Click **OK** when done.



- **Save as:** Save as other point with new name.
- **Delete This Point:** Delete the selected point.



IMPORTANT:

The point system and the nodes are mutually independent. The changes made in the **Point Manager** will be applied to all the nodes that use this point. Before the change, check all the nodes sharing this point again to avoid the occurrence of unintended motion.

5.6.1.6 Base Manager

Base Manager will list all the **Bases** that can be used, the **Current** tag will indicate the **Base** used by the robot at that time,  represents **Vision Base**, and  represents **Custom Base**. Clicking  on the right of the specific **Base** can access the information page of the **Base**. Clicking **Set as the current base** will change the current reference coordinate used by the robot to this **Base**. Beneath that information, there are tools provided for users to operate the **Base**. Refer to Chapter 6 Point and Base for the definition of **Base** and 7.2 Create a Custom Base for the details on how to create a **Custom Base**. Users can use dropdown to filter available base in the list, and sort bases in the list with the buttons of base order, reverse alphabetical, alphabetical, or chronological. Click the **Batch Delete** button to select multiple bases to delete.

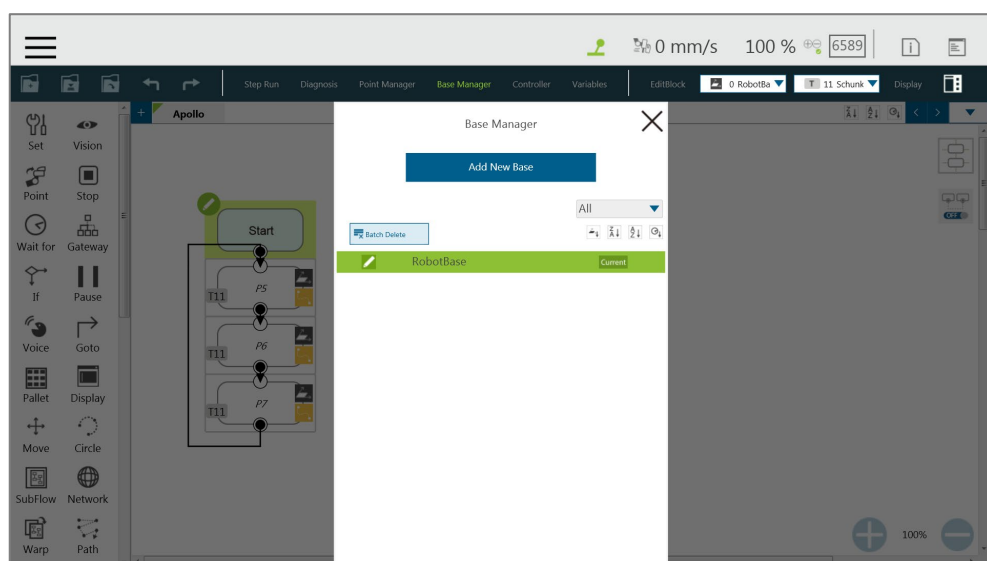

Figure 43: Base Manager

5.6.1.7 Controller

Controller provides users with direct control of the robot from motion control, IO control and **FreeBot** settings. Motion control includes three tabs: **Joint**, **Base**, and **Tool**, which correspond respectively to “move according to the joint angle setting”, “move according to the robot **Base** or the current **Base**”, and “move according to the **Tool Coordinate**”.

The Robot Link icon above the **Joint** tab is in green and connected when the I/O states, the safety connector states and the coordinates values are correct. If in gray, the Robot Link is disconnected, and the states and the values are not adequate for reference.

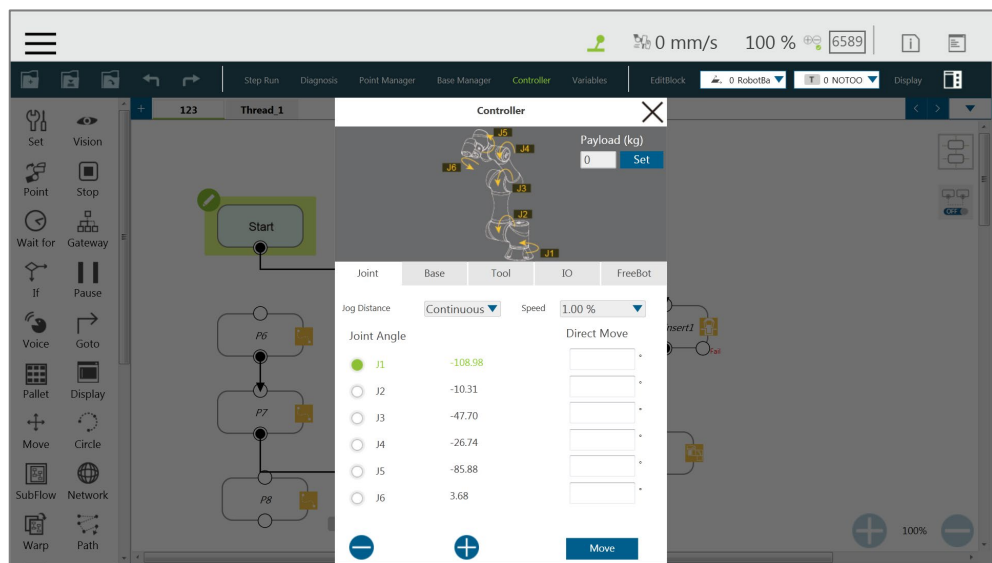

Figure 44: Controller

- Motion Control: In the tab of **Joint**, **Base**, or **Tool** tabs, there are two kinds of motion control methods:
 - Single-joint/single-axis movement
To use single joint/single-axis movement, click the joint/axis to be moved first, then press **+** or **-** on the left bottom corner, or press the **+** or **-** button on the Robot Stick to move the joint/axis in a positive or negative direction.
 - Moving to a specific target
To move a specific target, enter the target in the textbox on the right, then press and hold the Move button below to move the robot to the target position.

Note

NOTE:

- The selections in the dropdowns, the solid circles, and the input values in the fields will remain even after switching the tabs until users exit the **Controller**.
- **Controller** comes with the protection mechanism to prevent the joint to report the hardware error with the oversized interpolations from sending the position command with a large gap.

IMPORTANT

IMPORTANT:

The **Base** tab is used to move to a specified target with respect to the specified **Base**, and the **Tool** tab is used to move in a specified direction with respect to the **Tool Coordinate**.

- IO Control: Click **IO** tab to open the **IO control page**. In the **IO control**, the output value of each IO can be controlled independently, including **Control Box IO**, **End Module IO**, **Camera Module IO**, and **Safety Connector IO**. For detailed IO specifications and applications, refer to Chapter 12.3 IO.

Note

NOTE:

- **Safety Connector IO** is HW 3.2 or newer exclusive.
- **Safety Connector IO** is read-only and users cannot change the state in TMflow.

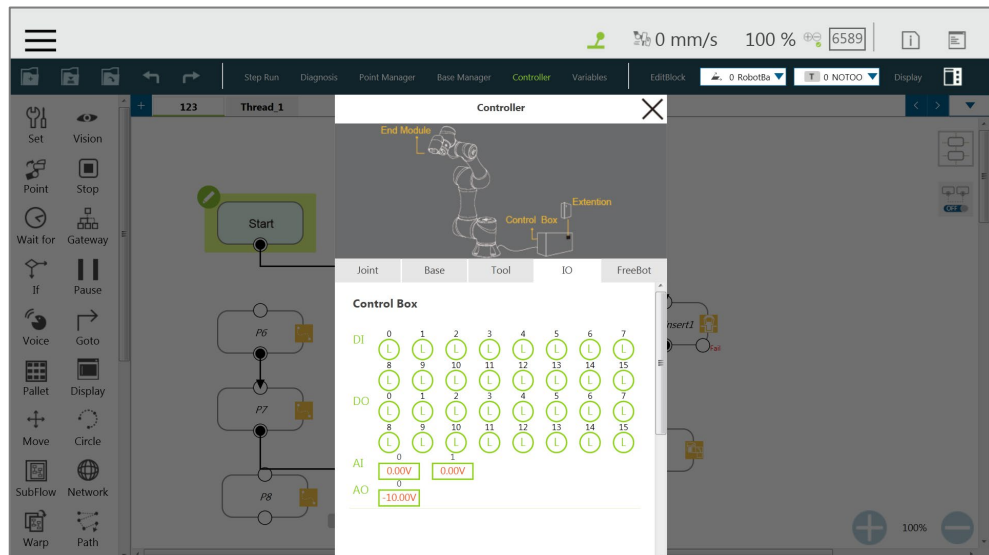

Figure 45: Controller (IO Control)

- FreeBot: In **FreeBot**, it defaults to **Robot Joints** as the **Control Mode** and the movement limits of the robot while pressing the **FREE Button** can be set. The settings are divided into **Free all joints**, **Free XYZ**, **Free RXYZ**, **SCARA like** and **Custom**

Setting. When the control mode is **Robot Joints**, Check **Clear Payload** and press the **FREE Button** to clear payload for obtaining the correct TCP force and joint torque.

Users can set the **Control Mode** to **F/T Sensor** for hand guiding in the current project and select the F/T sensor in the dropdown if installed an F/T sensor to the robot. If users exit the project, hand guiding with the F/T sensor becomes unavailable until users set the **Control Mode** to **F/T Sensor** in **Controller** again.

Note

NOTE:

- Users cannot hand guide when the project is running.
- All safety functions are effective in hand guiding with the F/T sensor.
- The indication light ring turns to red if an error occurred after users pressed the FREE Button to begin hand guiding with the F/T sensor. Press the FREE Button in the End Module or the Stop Button on Robot Stick to troubleshoot the error to turn the indication light ring to green and start over.

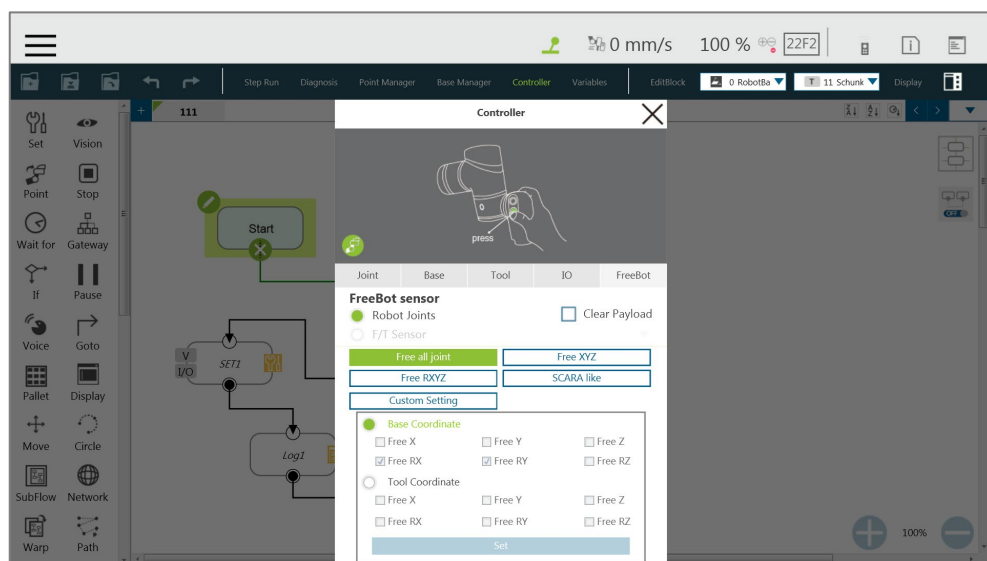

Figure 46: Controller (FreeBot Control)

- **Free all joint:** Freely drag the robot while pressing the **FREE Button**.
- **Free XYZ:** Use the **FREE Button** to make the robot performing translation-only motion in **Robot Base**.
- **Free RXYZ:** Use the **FREE Button** to make the robot performing rotation-only motion in **Robot Base**.
- **SCARA like:** Use the **FREE Button** to make the robot performing motion on X, Y, Z, RZ directions of **Robot Base** as the traditional SCARA robots. This mode is suitable for teaching simple pick and place jobs to avoid accidentally causing

unnecessary rotation in degrees of freedom when teaching.

- **Custom Setting:** Freely set the degree of freedom to be released and fixed, to facilitate hand guiding.

Button	Function
Free all joint	Six Degrees of Freedom, the robot end movement and posture change are not restricted
Free XYZ	Three Degrees of Freedom, the robot end can only move XYZ directions.
Free RXYZ	Three Degrees of Freedom, the end can only change its orientation
SCARA	Four Degrees of Freedom (X, Y, Z, RZ)
Custom Setting	Degrees of Freedom to be set by users.

Table 5: FreeBot Degree of Freedom Limitation



IMPORTANT:

The **FreeBot** setting is still valid after the controller page is closed. Therefore, if users find that the robot cannot be moved in certain degree of freedom, check whether the **FreeBot** setting is correct.

5.6.1.8 Variables

TMflow has its own variable system. All types, names, and initial values of all variables can be seen in the variable list. The variable types include both single variables and arrays, and the new variables can be added through the **Create Variable** button or the **Create Array** button. In the naming rule of variables, only the digits, underline and the upper case and lower case Latin alphabets are supported. Users can sort variables in the list with the buttons of reverse alphabetical, alphabetical, or chronological.

Users can use **Import/Export** to read text files as entities, and users can break them down into pieces or trace them back to the plain code with programming. The text file to read must be less than 2MB in the assigned path. Users can use **Text File Manager** in **Robot Setting** to check text files in the list. **Variables** created with the type of string can read data in the text files as values. **Array**, **Global Variables**, and **Variables** created with other types are not supported.



IMPORTANT:

- Use " " to enclose the string when inputting the string value to avoid being treated as a variable.
- Do not use reserved words such as var in naming.

5.6.1.9 EditBlock

By extending the **EditBlock** menu, multiple nodes can be selected, either by dragging the mouse, while pressing the left mouse button, to draw a frame around the desired icons, or by simply clicking each desired icon. Clicking a selected icon deselects it. Users can drag and drop all the selections, click the **Copy** and **Paste** icon to copy and paste all selected nodes, or perform **Base Shift** or **Speed Adjust** for all nodes. Moreover, users can set **Payload** with a value or a variable in integer, float, or double, check the options in **Blending** to reduce the number of robotic brakes and the cycle time, and **Precise Positioning** to set how nodes locate in particular. All **EditBlock** related behaviors, including copy-and-paste function, can only be performed under the same project.

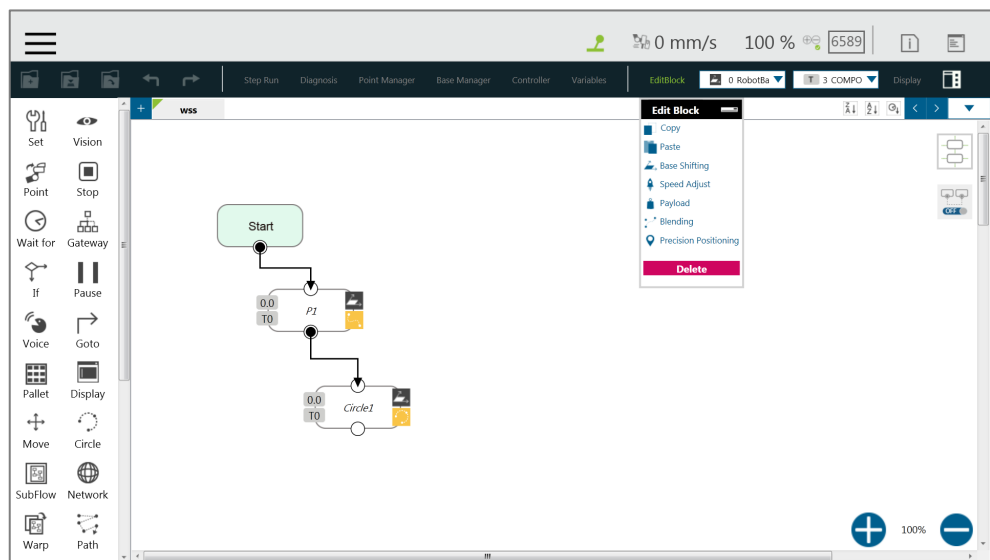



Figure 47: EditBlock

5.6.1.10 Current Base and Base List

Base list will list all Bases for this project and also indicates the **Current Base**. In the base list, the front symbol represents the type of **Base**, and  represents **Vision Base**,  represents **Custom Base**. The **Base** displayed in the box is the **Current Base** and can be replaced through clicking the list.



IMPORTANT:

When users click on the **Base List** and add a new point, the point will be recorded on the **Current Base**.

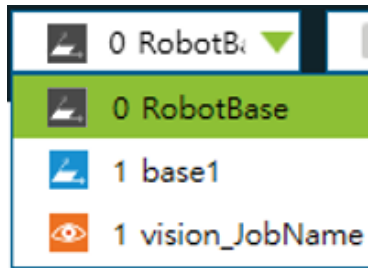

Figure 48: Base List

5.6.1.11 Current TCP and TCP List

TCP list will list all the TCPs. In the TCP list, the front symbol represents the type of tool, **T** represents the general TCP, and **V** represents the built-in TCP list of the hand-eye camera. The TCP displayed in the box is the current TCP, and can be replaced by clicking on the list.



IMPORTANT:

When users click the TCP list and add a new point, the point will be recorded with the current TCP.



Figure 49: Tool List

5.6.1.12 Display Manager

In **Display Manager**, users can set the variables to be displayed on the display panel and interact with users when the project is running. Variables are divided into two types: displayed to users and input by users. The page where users may input variable value can be protected with a password, to avoid unauthorized operators intervening with or modifying the robot's motion behaviors by modifying the variables. On the top part of the display management panel, the time period of the refreshing of the display of variables can be selected from 300, 500, or 1000 in milliseconds. The variable will update the display information according to the set time. Set the refresh time appropriately to avoid users receiving wrong variable information.

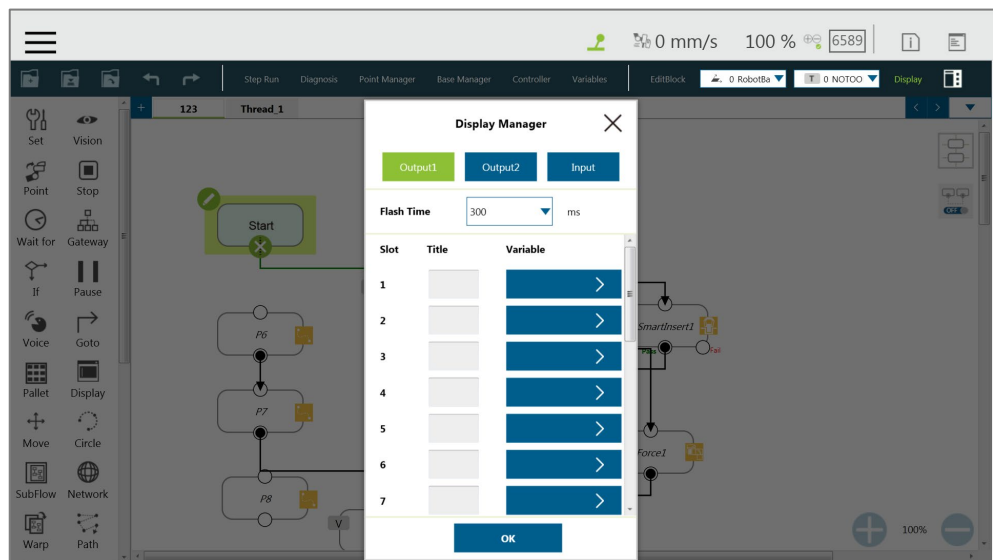

Figure 50: Display Manager

5.6.2 Node Menu and Flow Editing Area

In the **Project Editing Page**, users can create projects. The node menu in the left side is a list of nodes that can be used. Drag the icon of each node to the **Flow Editing Area** to create Flow. Users can click the pencil icon on the node to name the node in the field next to **Node Name** if available. The maximum characters available in the field is 50.

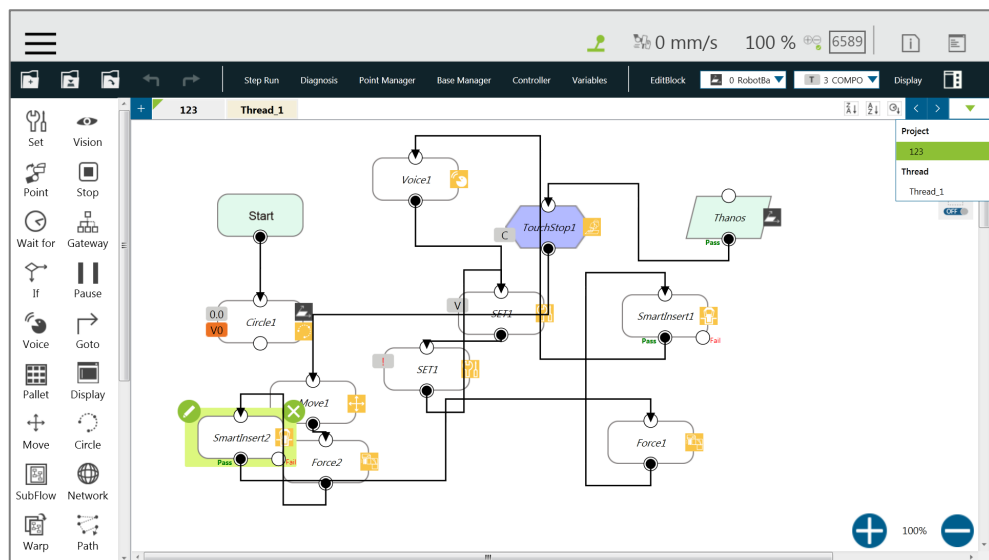









Figure 51: Project Edit (1/3)

The green triangle at the top left of the tab denotes in use currently. At the top right of the project editing page, users can click , , or  to sort the tabs of the project editing pages in the orders of reverse alphabetical, alphabetical, or chronological, and click  as a dropdown to switch between subflows.

At the bottom right of the project editing page, users can click  or  to change display percentage for easier reading, click  to enable automatic connection mode by clicking any two nodes in the automatic connection mode to connect both of the nodes based on the clicking order, and click  again to exit the automatic connection mode upon completion of programming.



NOTE:

- Tabs will be sorted by types with colors in the order of the following.
Thread (pale yellow) > Subflow (pale blue)
- Identical user-defined names of threads are sorted chronologically.
- If you use a touch screen for project editing, automatic connection mode will greatly simplify your connection process, dragging between each endpoint is no longer needed, simply enable the automatic connection mode and click on the nodes desired to be connected to connect.

Users can click  at the top right, select nodes, and click the icon of the desired arrangement at the top right to align nodes in the page as shown below. The first selected node acts as the alignment node for the other nodes. If the first node is deselected, the second selected node becomes the alignment node.

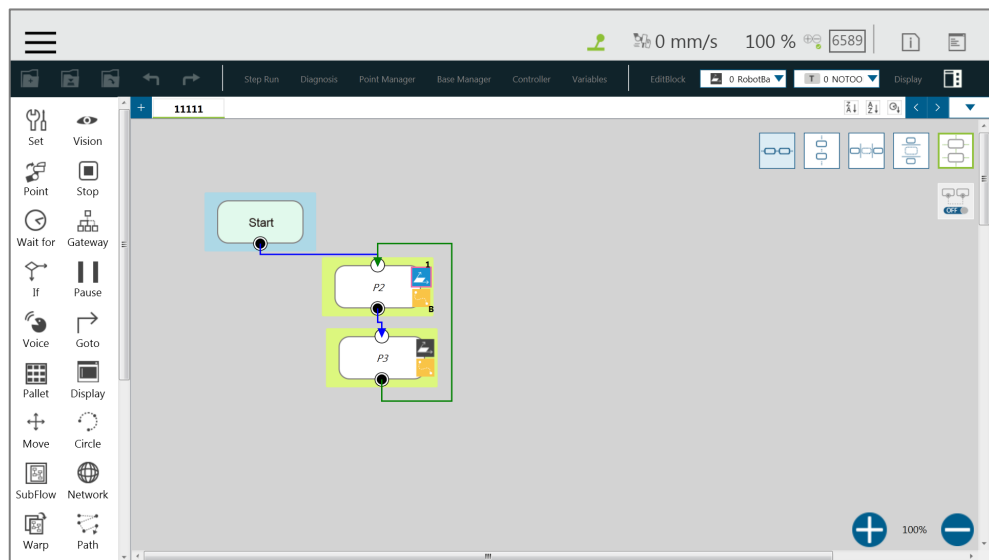

Figure 52: Project Edit (2/3)



Figure 53: Project Edit (3/3)

5.6.3 Project Function Menu

The **Project Function Menu** will display the settings and tools related to the project, including search function, **Operation Space**, **Modbus Device**, **Set IO while Project Error**, **Set IO while Project Stop**, **Stop Watch**, **View**, **F/T Sensor**, **Serial Port**, **Path Generate**, and **Joint Loading**.

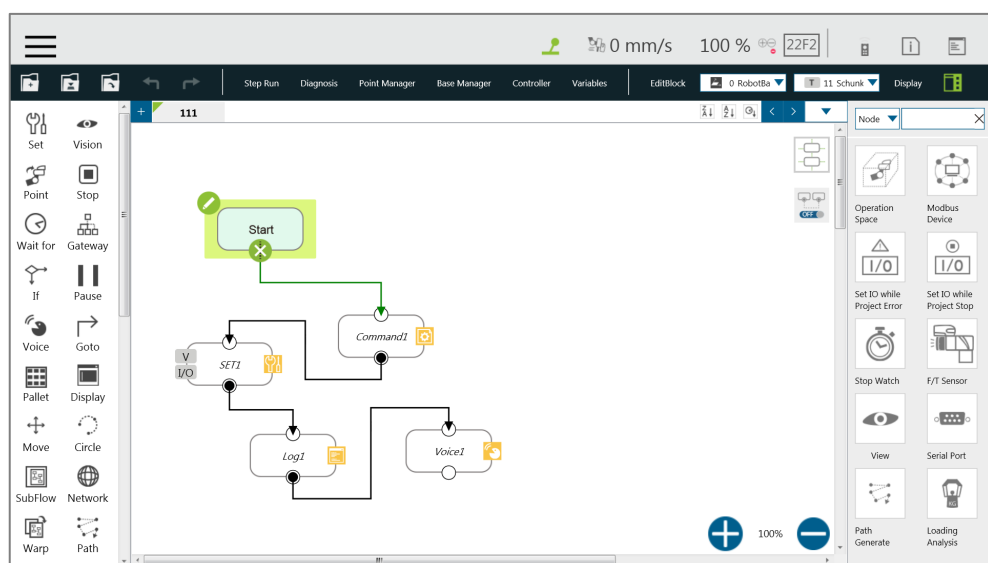

Figure 54: Project Function Menu

5.6.3.1 Search Function

In Search Function, the search can be performed by the node name or variable name. Click the first search box to determine the search target (searching with node name or variable name used in the node). If searching with a node name, select , and input the keyword in the search box behind it. If searching with a variable, select , and input

the variable in the input box. The ▼ in the input box can be clicked to input from the pop up variable list, or input the keyword directly. The search limit condition can be specified below the search box, for users to narrow the search range so that users can filter out the desired targets. If you want to jump to a specific search result, click ◀ in front of the item in the result list directly.

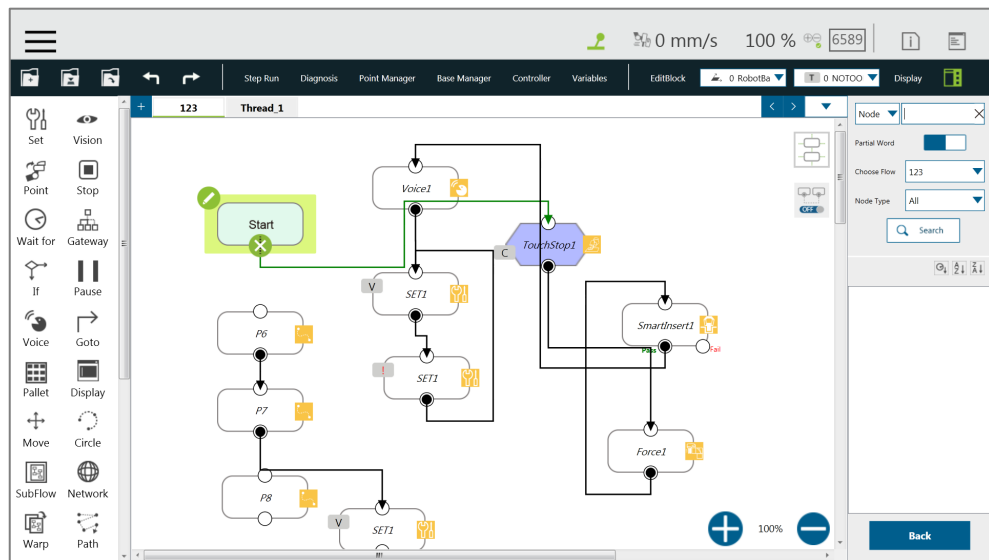

Figure 55: Searching Pane

5.6.3.2 Operation Space

Operation Space can be used to set the operation space configuration of the project. Refer to Chapter 15 Operation Space for instructions.

5.6.3.3 Modbus Device

Modbus Device can be used to set the Modbus master/client in the project. Refer to 12.1 Modbus for instructions.

5.6.3.4 Set IO while Project Error

This tool can set the IO output status when the project has an error. Refer to 12.3 IO for instructions.

5.6.3.5 Set IO while Project Stop

This tool can set the IO output status when the project stops. Refer to 12.3 IO for instructions.

5.6.3.6 Stop Watch

Through **Stop Watch**, users can calculate the running time elapsed between two nodes, plan

the motion, manage the production cycles more conveniently through the **Stop Watch** runtime analysis tool, and optimize time for each flow. After clicking **Stop Watch**, click **New** to add a stop watch. **Stop Watch** includes four parts, the beginning node, the ending node, records in a specific variable, and the note description. Check the bullet before **Start** or **End**. Then, click the note to be configured to complete the configuration. To save the variable, when **Stop Watch** is running, the time result obtained while running can be output as the variable to help users analyze this parameter. Select a double type variable in the variable list and fill in the variable box to use this function.

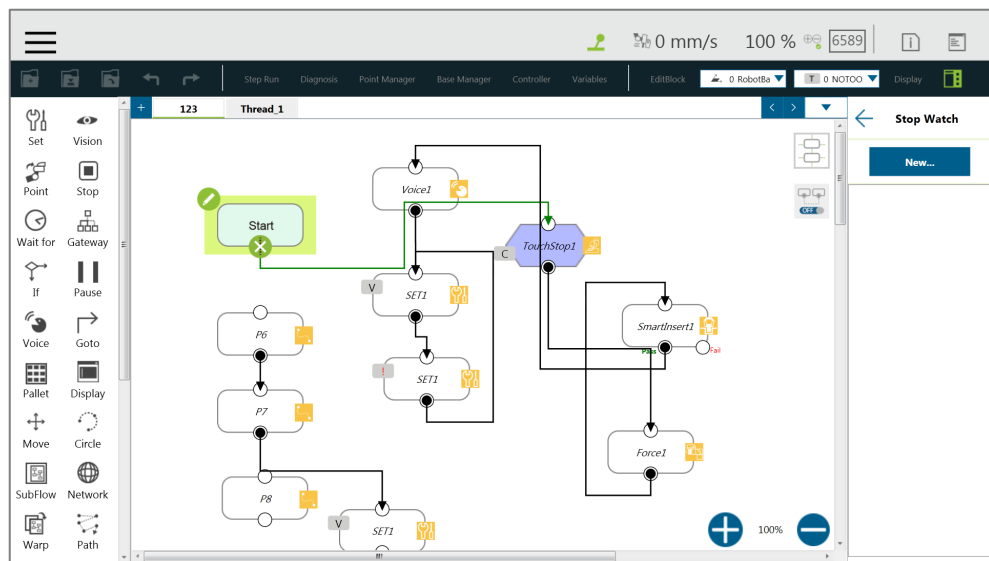

Figure 56: Stop Watch Setting Page

5.6.3.7 View

View provides users with a quick view of the current camera's live image. The camera name can be selected in the upper left corner of the image. Click  below the image to bring up the camera adjustment parameters.



Figure 57: View Tool Floating Window

5.6.3.8 F/T Sensor

Refer to 14.2 F/T Sensor for instructions.

5.6.3.9 Serial Port

Users can add devices with serial communication interfaces in **Serial Port**. Simply click the icon of **Serial Port** to manage the serial port devices.

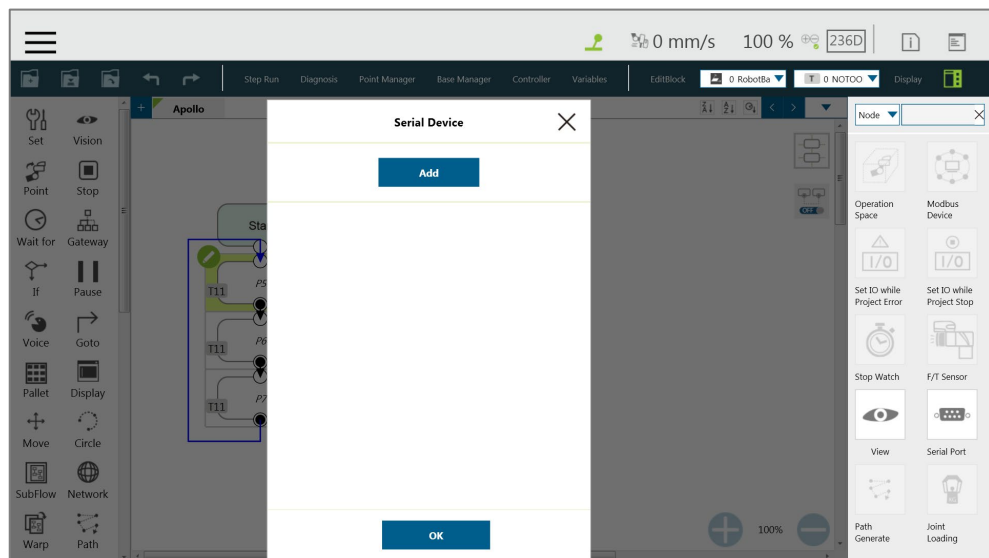

Figure 58: Serial Port (1/2)

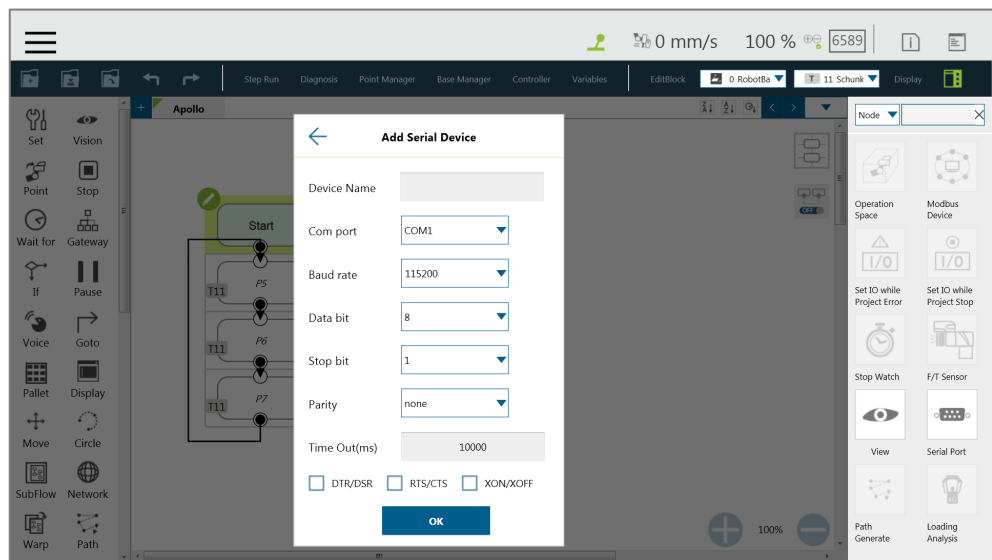



Figure 59: Serial Port (2/2)

- To add a device, click **Add**, enter values for **Device Name**, **Com port**, **Baud rate**, **Data bit**, **Stop bit**, **Parity**, **Time Out** in the respective fields as well as check the hardware and software flow control options, and then click **OK**.
- To edit a device, click on the name of the device, and click on the pencil icon to edit. Every field but **Device Name** is editable.
- To delete a device, click on the name of the device, and click .



Note

NOTE:

- The **Modbus** tab in Expression Editor is replaced by the **Connection** tab, and Modbus is in the **Protocol** dropdown.
- The **Baud rate** dropdown offers choices of: 300, 1200, 2400, 4800, 9600, 14400, 19200, 38400, 57600, 115200. Users can also input a custom baud rate in the dropdown.

5.6.3.10 Path Generate

In **Path Generate**, users can generate complex curves by hand guiding with the F/T sensor. Simply click the icon of **Path Generate** to use the function.

-  Create a new motion record.
-  Open a motion record or a path file.
-  Save as a path file applicable to the path node.

- Choose the base and the tool in the dropdowns at top right. Click the record icon to start recording the path. Hand guide the robot moving while recording is in progress. Click the stop icon to stop recording.

- Click the **Time** button to set **Time Sampling** parameters. Click the **Position** button to set **Position Sampling** parameters. Points on the path in the 3D viewer vary from **Time Sampling** and **Position Sampling**.
- Click the **Run** button for the trial run with the recorded path. Users can set **Direction**, **Data Type**, or **Speed**. Click the Move (+) button or the + button of the robot stick to move the robot along the recorded path. Hold the button for continuous moving. Click the **Reset** button to set **Direction**, **Data Type**, or **Speed** again.



NOTE:

The motion record is generated after recording the path with the lowest possible sample rate and the distance log. The motion record is not applicable to the path node. Save the motion recorded as a path file to use in the path node.

5.6.3.11 Joint Loading



Joint Loading can monitor the loading that every node brings to the robot joints and keep repeating peak torque away. Simply click the icon of **Joint Loading** to use the function.

Follow the steps below to use **Joint Loading**:

1. Click the switch next to **Show Indicator** to turn on or off the rectangle encloses each node in the project.
2. Check or uncheck the desired levels of the risk indication on each node.
3. Click the **Apply** button to have the setting take effect.

Once **Show Indicator** turned on and all levels of the risk checked, the rectangle encloses each node in yellow for **High Risk**, green for **Low Risk**, and gray for **Unknown**. To turn off the rectangle encloses each node, switch off **Show Indicator** in **Joint Loading**.

Below the **Apply** button, every node in the project will be listed with the type and the name.

Joint Loading on every node takes effect after the project execution. The high risk node will come with the reference speed reduction ration in the list. Users can click , , or  to sort the listed nodes in the orders of reverse alphabetical, alphabetical, or chronological.

5.7 Robot Setting

The parameters related to the robot can be set in **Robot Setting**. The parameters, from left to right and from top to bottom are: **Wizard**, **Vision Setting**, **TCP**, **IO Setting**, **Safety**, **Controller**, **Speech**, **End Button**, **Component**, **Operation Space**, **Command**, **Connection**, **Posture Setting**, **TMmanager**, **Global Variable**, **Text File Manager**, **Motion Setting**, and **TM AI+**.

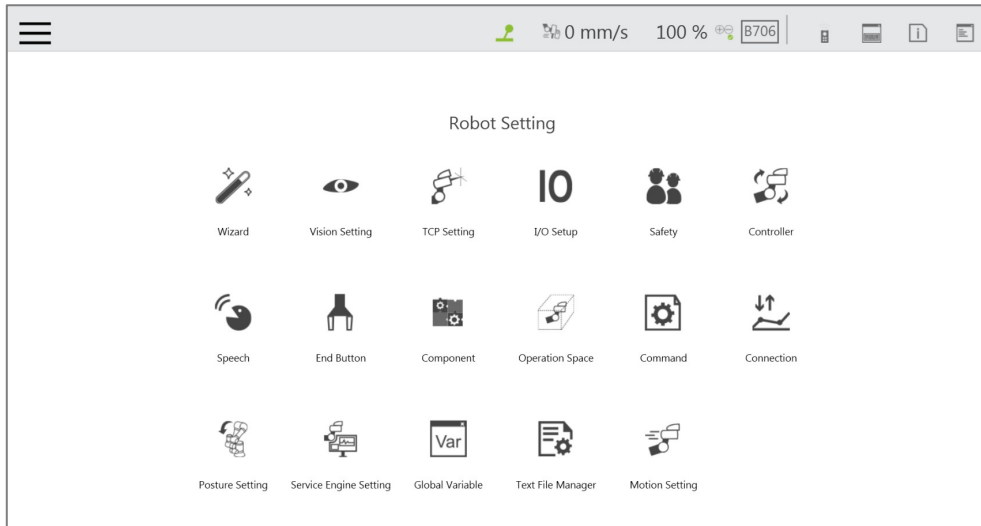

Figure 60: Robot Setting

5.7.1 Wizard

The robot setting **Wizard** will guide users through robot basic settings step by step, including language, time and date, network setting and speech setting.

5.7.2 Vision Setting

Vision Setting allows users to modify the camera parameters and manage vision files.

5.7.3 TCP

In **TCP setting**, users can create a TCP through **FreeBot** teaching and Manual-inputting parameters. Refer to 8.2 TCP Setting for instructions.

5.7.4 IO Setup

In **IO Setup**, the default value of the output signal at the time of starting up, and the meaning represented by the **Self-Defined IO** can be set. Using **Self-Defined IO**, users can trigger or read the button on the **Robot Stick** with an external device through the IO port on the **Control Box**. After the setting is complete, click the **Save** button in the lower right corner to save the setting.

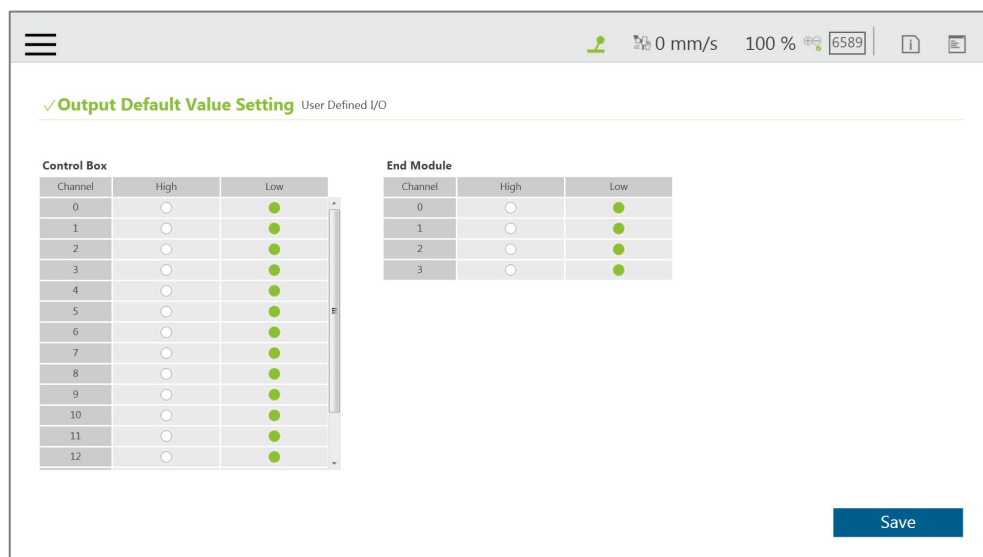

Figure 61: Output Default Value Setting

Control Box Input channel	Meaning	Control Box Output channel	Meaning
9	Stick + button	9	Stick + button
10	Stick - button	10	Stick - button
11	Stick M/A Mode button	11	Stick M/A Mode Button
12	Stick Play button	12	Stick Play Button
13	Stick Stop button	13	Stick Stop Button
		14	System Error Indicator
15	Simulated E-Stop button	15	Simulated E-Stop button

Table 6: User Defined IO Setting Table

5.7.5 Safety

In **Safety**, users can set **Safe Stop criteria**, **Safeguard Port Setting**, etc. Refer to Chapter 3 Safety Settings for details.

5.7.6 Controller

Refer to 5.6.1.7 Controller for details.

5.7.7 Speech

In **Speech**, users can set the speech parameters, including the buzzer, speech function and error message broadcasting or not, broadcast language, speed and volume. To use the speech function, connect a speaker to the **Control Box**.

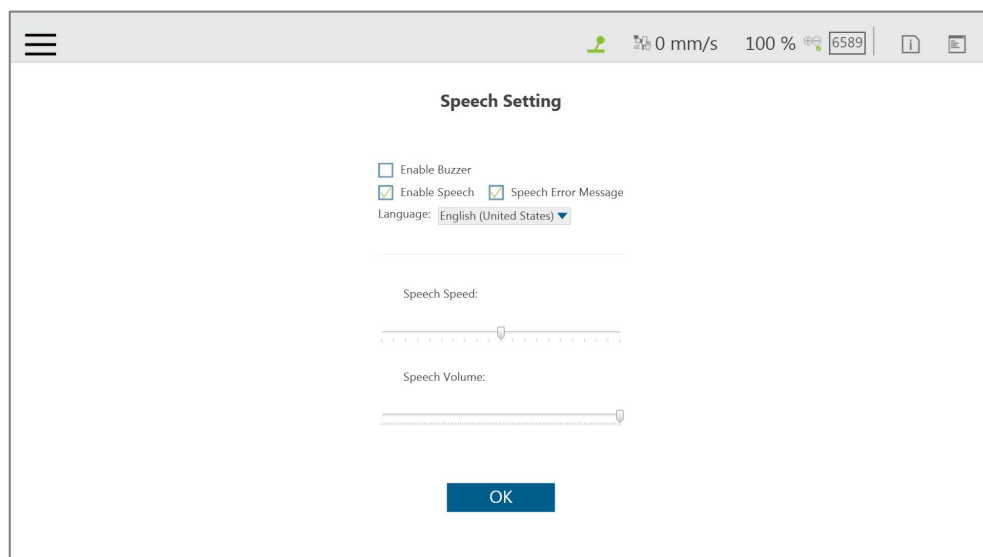

Figure 62: Speech Setting



CAUTION:

If using "**Speak and Move**", the speech will be saved into a buffer and deleted only if the system finished speaking it. That means, if the **Voice** is used in a **Thread** with a quick loop, the buffer size will increase quickly, that the robot might keep speaking without ever stopping.

5.7.8 End Button

In **End Button**, users can set the behavior when the **Gripper Button** on the **End Module** is pressed or set the **Vision Button** for **Smart-Pick** in vision jobs.

For the **Gripper Button**, if the gripper used is a general I/O type gripper, click **Grip** to set the IO signal required to close the gripper. Click **Release** to set the IO signal required to open the gripper. If the gripper in use needs **TM Component** to operate, select the user-defined component. Refer to Chapter 13 Component for use of TM Component.

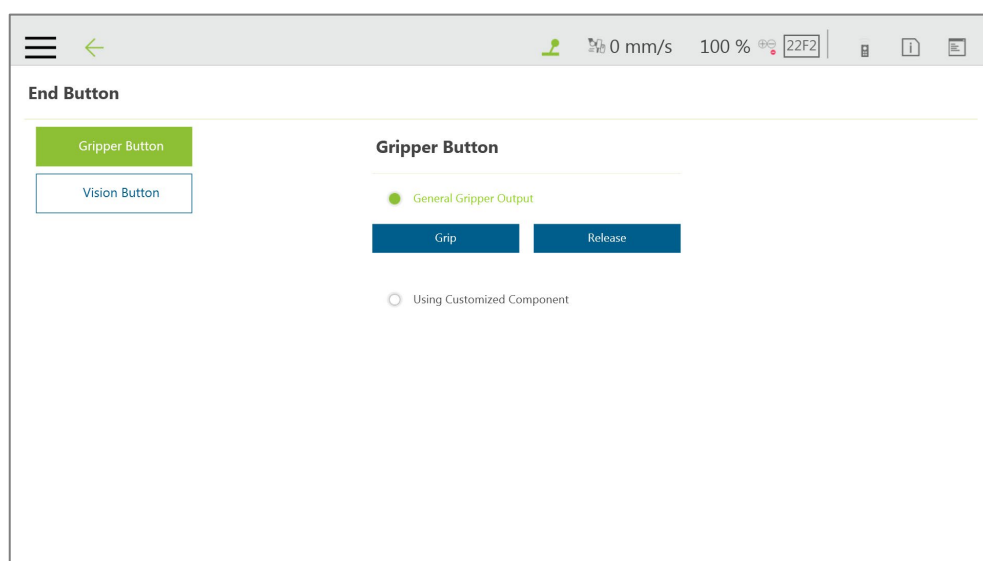



Figure 63: Gripper Button

To set the **Vision Button** for **Smart-Pick**:

1. Navigate to , and click **Setting**.
2. Click the **End Button** icon.
3. Click **Vision Button** and click the bullet before **Smart Pick**, and users can now create vision jobs with **Smart-Pick**.

5.7.9 Component

In **Component**, users can select the component to be started from the **Component List**. Refer to 13 Component and 16 TM Component Editor for details.

5.7.10 Operation Space

For the method of using **Operation Space**, refer to Chapter 15 Operation Space.

5.7.11 Command

In **Command**, users can check the command status as well as enable or delete the command from the **Component List**. Click the **Save** button to take effect. Refer to 12.4 Command for details.

5.7.12 Connection

In **Connection**, users can set **Modbus Slave** related settings, **TM Ethernet Slave**, and **Profinet Server**. Make sure the card does secure to the designated slot and the cable does connect to the appropriate port before setting items in **Connection**.

For **Modbus Slave**, the system provides two Modbus communication methods: **Modbus TCP** and **Modbus RTU**. Click  on the top to turn on/off the mode. Once **TCP** is turned on, the system works as a **Modbus TCP** server for user configured clients with IP filtered and permissions to access robot data. If **RTU** is turned on, it is possible to access robot data with configurations via serial connections. Click the **Code Table** button in the lower left corner to open the Modbus slave encoding definition file.

To use **TM Ethernet Slave**, click  on the top to turn on/off the mode. Once turned on, the system works as a socket server for users to configure clients with IP filtered and permissions to access robot data. **TM Ethernet Slave** follows the protocol introduced in the manual *Expression Editor and Listen Node*.

To use **Profinet Server**, click  on the top to turn on/off the mode. Once turned on, the system works as a server for Profinet supported devices to access robot data. The context after
Software Manual TMflow Software version: 1.80

STATUS denotes the current **Profinet Server** status. For **Endianness**, users can click on the respective bullet to place the most significant byte first and the least significant byte last with **Big-endian** or the opposite with **Little-endian**. To check the data table, click the **Code Table** button.

To use the **Profinet** functions in **Expression Editor Setting**:

1. Click the right field of the expression.
2. Click the **Connection** tab, and select **Profinet** in **Protocol** dropdown.
3. Select the desired item in the **Function** dropdown.



NOTE:
When turning on **Profinet Sever**, if a message prompts users

- for the listed field bus is enabled, please disable the current activated field bus before changing the setting.
- for rebooting the robot, please power cycle the robot to change the firmware of the field bus device and manually enable the target field bus in the setting again.
- for failed to activate device, please check the device and the driver are both installed correctly.

5.7.13 Posture Setting

Posture Setting provides a convenient tool for users to quickly move the robot to a commonly used pose. They are **Packing Pose**, **Normal Pose**, and **Home Pose** from top to bottom.

Packing Pose can reduce the space occupied by the robot to help users pack and transport the robot. **Normal Pose** is the most common work starting pose of the TM Robot, and **Home Pose** is the pose with all joint rotation angles are 0 degrees.

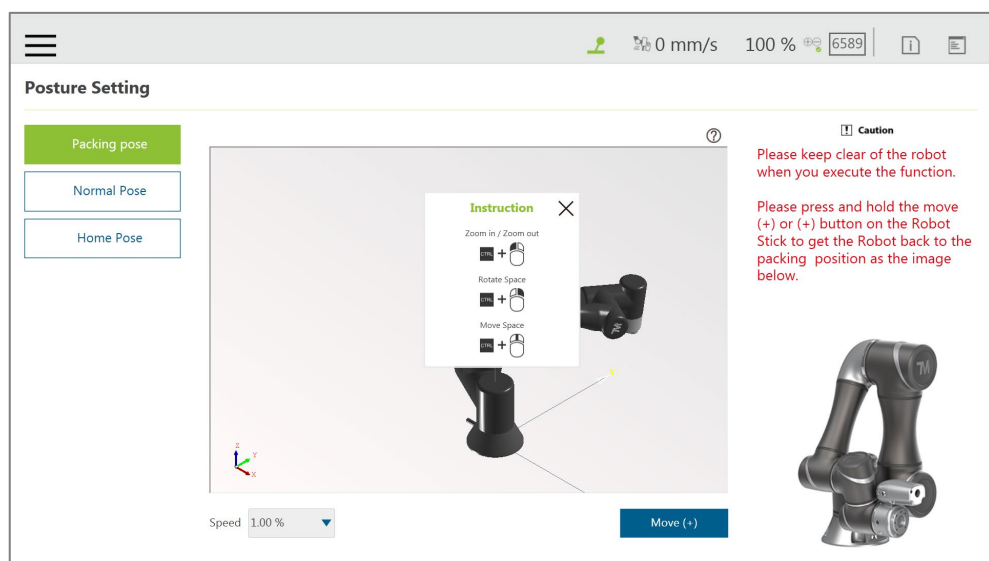



Figure 64: Posture Setting

Note

NOTE:

Click on  at top right of the 3D viewer for the instructions of the mouse operations.

5.7.14 Global Variables

The use of **Global Variables** is similar to the variable system in the project, but the variables in this system can be used in all projects. Refer to 10.2.1.1 Global Variables for instructions on using **Global Variables**.

5.7.15 Text File Manager

The **Text File Manager** contains a list of text files and IODD files that have been imported to the control box. String variables from the **Variables** menu can be used to read data from imported text files. **Array**, **Global Variables**, and **Variables** of other types do not support this feature.

5.7.16 Service Engine Setting

In **Service Engine Setting**, users can send robot data to the Service Engine at a remote site to make use of the data.

To start send robot data to the Service Engine at a remote site, follow the steps below.

4. Navigate to , and click **Setting**.
5. Click the **Service Engine Setting** icon.
6. Check **Enable Service Engine Setting**.
7. If required, check **Enable auto upload data to server** for the remote site to obtain the IP setting and the related parameters of the robot.
8. In the fields below **Server Setting**, fill the IP address and port number of the remote site.
9. Click **OK** when done.

5.7.17 Motion Setting

In **Motion Setting**, users can set **Automatic Speed Suppression** to have the robot adjust its rate of motion by the custom values of the TCP speed and the Joint Speed. Check the box before **Automatic Speed Suppression**, refer to the formula of **Target speed** to input the values in the fields next to **A** and **B**, and click **SAVE** when done.

The custom values of the TCP speed and the Joint Speed are set in

Setting>Safety>Performance Settings and **Setting>Safety>Human-Machine Safety Settings>More Limit Setting** for normal mode and collaborative mode, respectively.



NOTE:
Motion Setting is applicable to the following nodes:
Point Node, Circle Node, Pallet Node, Move Node, F-Point Node, Touch Stop Node (Line), Vision Node (Fixed Point), Vision Node (Servoing), and Path Node.

5.8 System Setting

System Setting includes settings related to this software. From left to right and from top to bottom, they are: **Language**, **System Update**, **Group**, **User Account**, **Network**, **Import/Export**, **Date and Time**, **Administrator Setting**, **Network Service**, **Backup/Restore**, **Input/Display Device**, and Auto Remote mode.

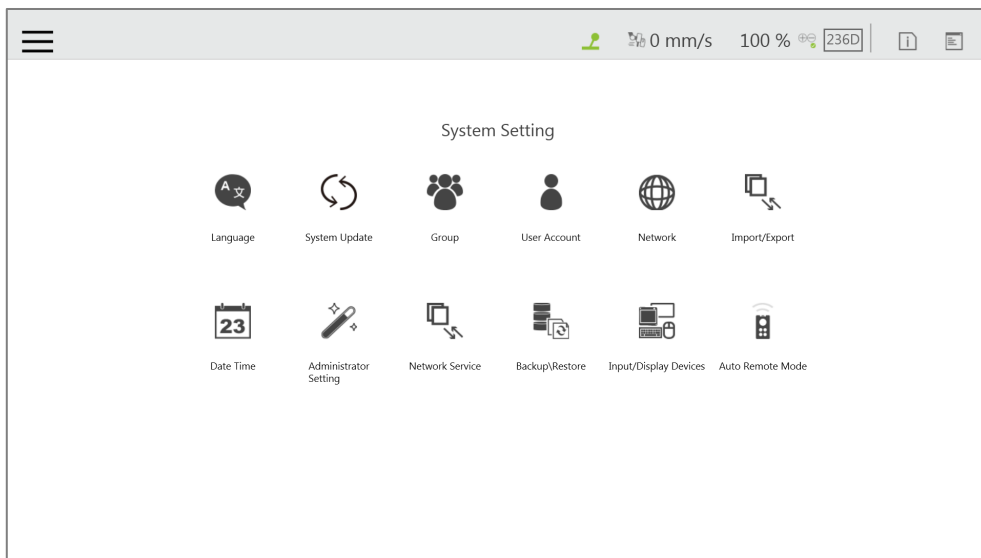



Figure 65: System Setting

5.8.1 Language

Select the icon of the language to display on the system. Click  to update with the language pack if available.

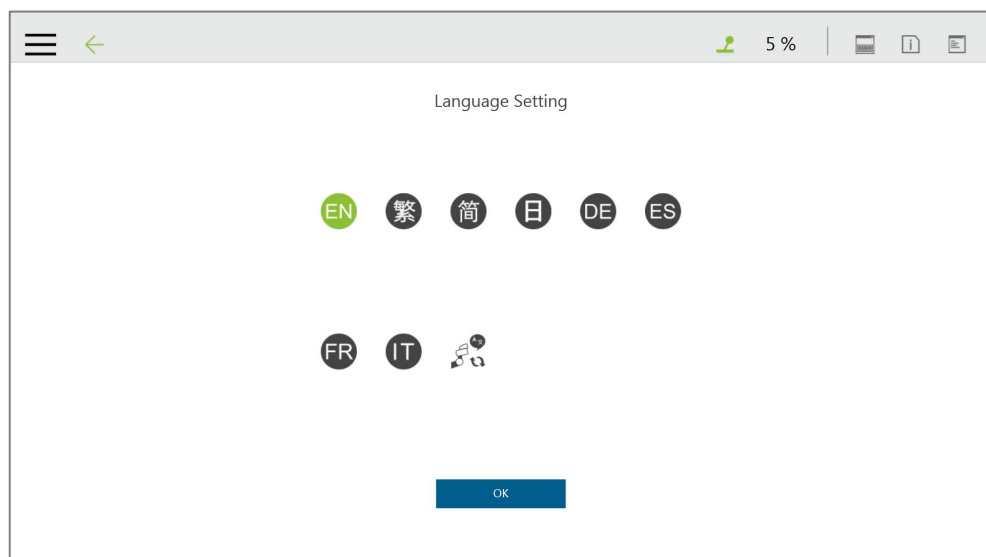

Figure 66: Language Setting

5.8.2 System Update

To update the **TMflow** on the robot, users need to download and unzip the update files from the website of the Company. Then, place all the content generated from the unzipped files into the root directory of the USB flash drive labeled with **TMROBOT** as shown, plug into the USB port on the **Control Box**, and click the **OK** button on the **System Update** page to start the update.

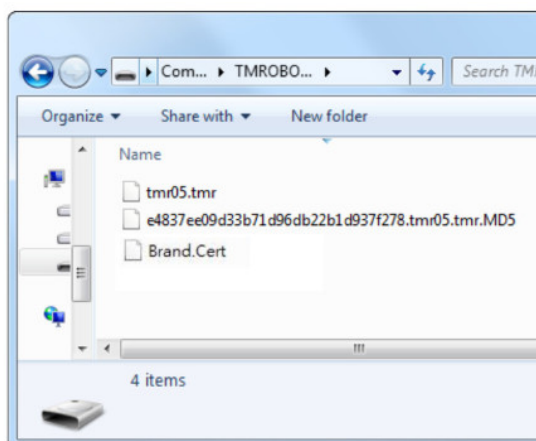

Figure 67: System Update (1/2)

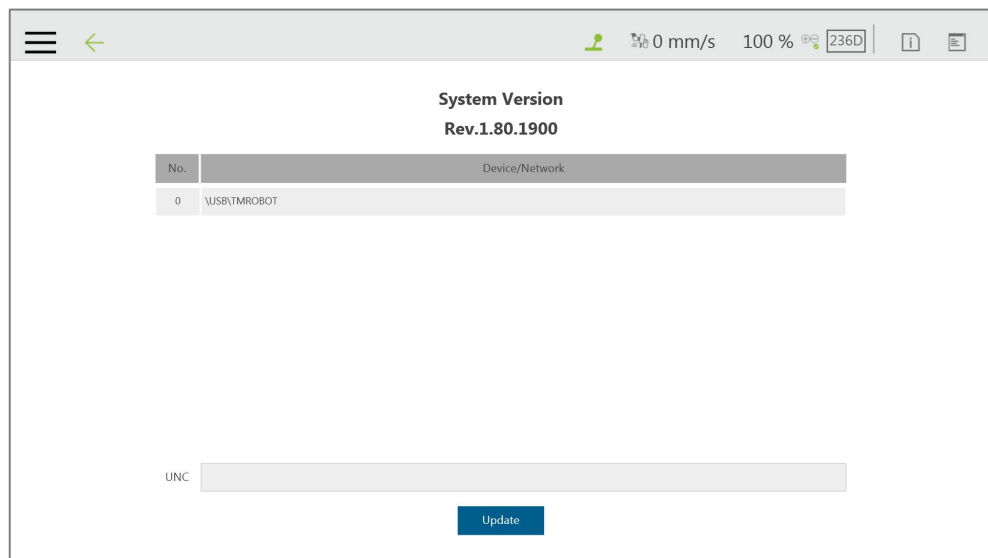



Figure 68: System Update (2/2)

5.8.3 Group

In this setting, the user group can be created. Enter the **Group** name in the right pane. Select the scope of this **Group's** permissions when creating, including run setting, project, settings, view, system. Press **OK** after settings are completed to create the **Group**. After creating the **Group**, click  to modify information, or click  to delete a group.

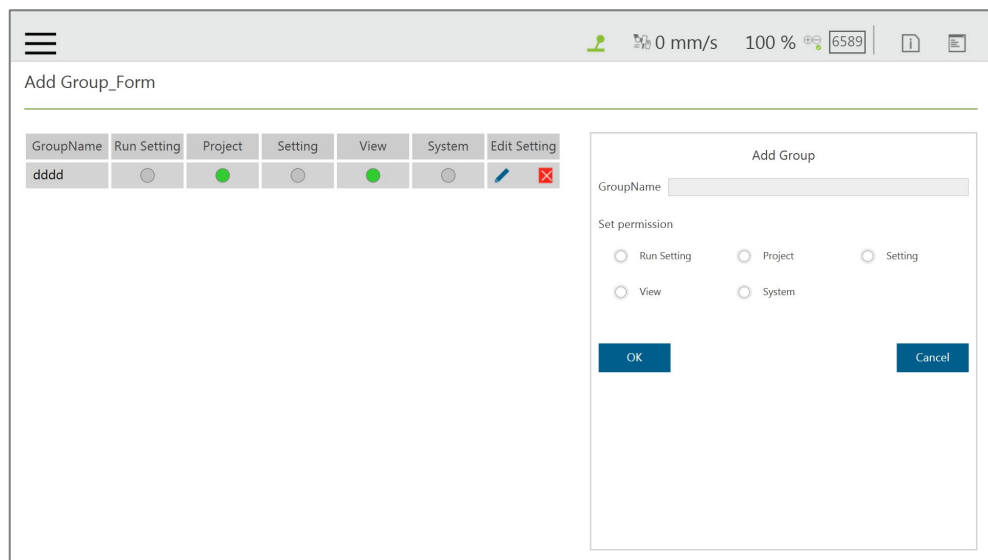



Figure 69: Group

5.8.4 User Account

In this setting, the **User Account** can be created. Enter the **Name** and the **Password** in the right pane to **Add User**. Users must select the **Group** to set the access permissions when creating the **User Account**. After creating the **User Account**, click  to modify information, or click  to

delete the User Account.

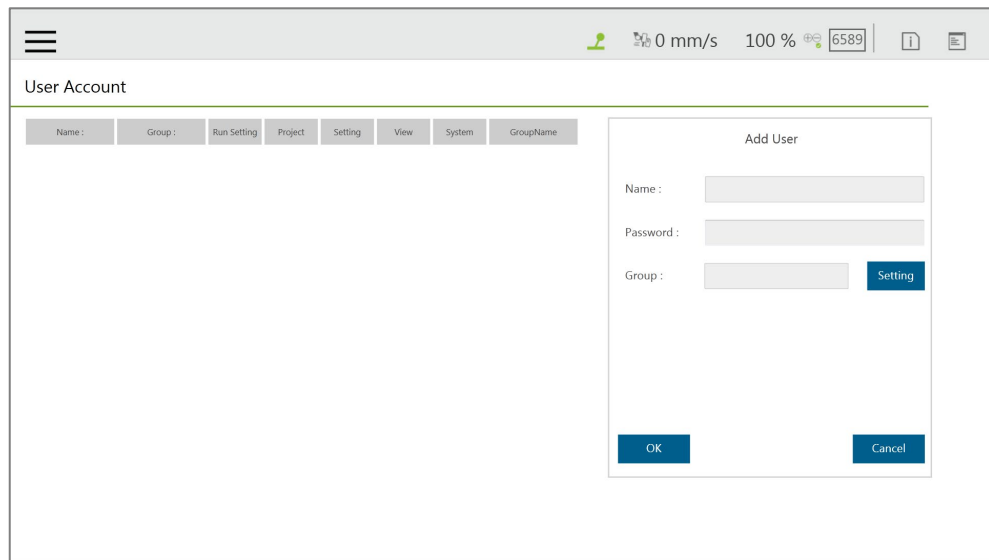

Figure 70: User Account

5.8.5 Network Setting

In **Network Setting**, the currently enabled connection list will be displayed. Click the item to set its parameters. If users choose Get IP from DHCP, the current connection IP will be grayed out.

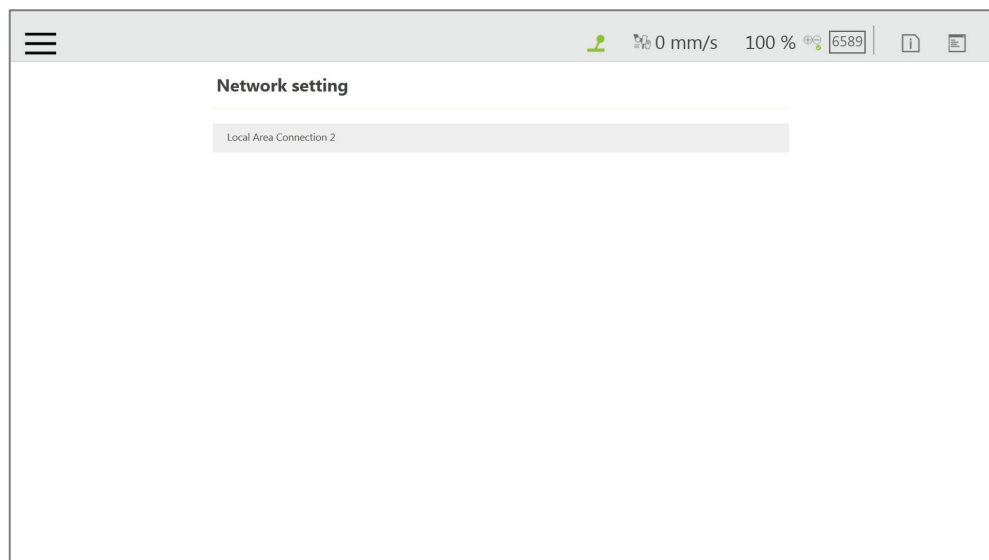

Figure 71: Network Setting (1/2)

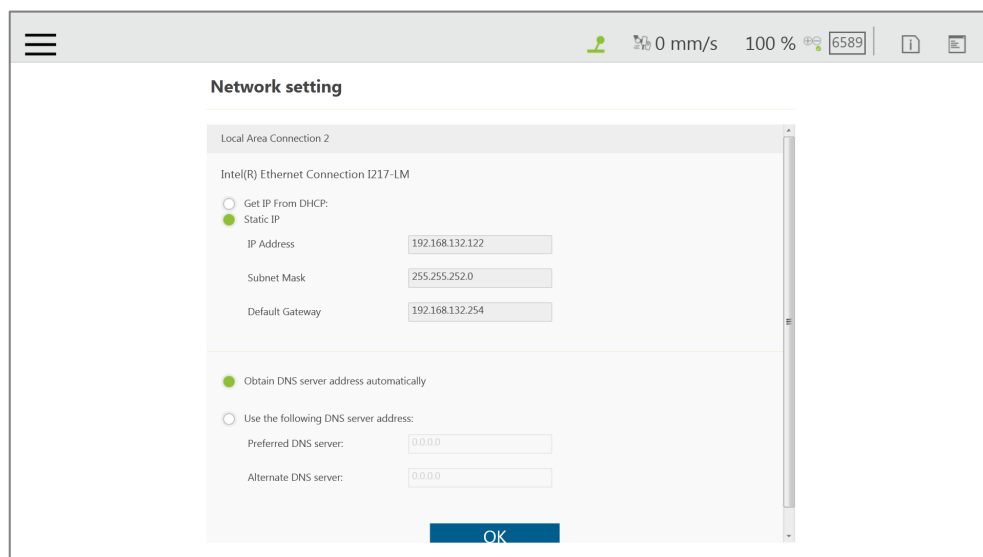

Figure 72: Network Setting (2/2)

5.8.6 Import/Export

In **Import/Export**, users can import items from the flash drive or export items to the flash drive. The label of the flash drive must be **TMROBOT**. Insert the flash drive to the Control Box before using the function.

- To use the Export function:
Click the **Export** button at the top left, and then select the desired file in the **Select file** box. Click the item in this box to add the item to the **Selected files** box. After completing the new addition, click **Export** at the bottom right to start the **Export** procedure.
- To use the Import function:
Click on the **Import** button at the top left, select the robot of the data source in the flash drive from the robot list, and then select the desired data from the **Select file** box. Click an item in this box to add the item to the **Selected files** box. After completing the new addition, click **Import** at the bottom right to start the Import procedure.



NOTE:

While using **Import/Export**, if there are duplicated **Project** files in the **Selected files** box, after clicking either **Import** or **Export** at the bottom, users can choose from **YES** to overwrite, **NO** to save as, or **CANCEL** to cancel the Import or Export. Checking the box next to **Apply to all folders** will apply YES (overwrite) to all remaining duplicates.

Available data types to import or export:

Log, Hardware Record, Project, TCP, Command, Component, Point Base, Operation Space, Global Variable, Path, Modbus, F/T Sensor, Network Service, Text file, IODD Files,

Ethernet Slave, Backup File.

Examples:

- | | |
|---|---|
| <ul style="list-style-type: none">● To export the settings relative to the F/T sensor along with the project: <ol style="list-style-type: none">1. Navigate to ☰, click System > Import/Export.2. Click Export on the top left, and click Project.3. Select the name of the project to export in Select Files. Once selected, the project to export will be listed in Selected Files.4. Repeat Step 3 if you wish to select more projects to export.5. Click Export at the bottom right to export projects when done selecting. | <ul style="list-style-type: none">● To import the settings relative to the F/T sensor along with the project: <ol style="list-style-type: none">1. Navigate to ☰, click System > Import/Export.2. Click Import on the top left, and click F/T Sensor at the bottom left.3. Select the robot to apply the imported setting in the Robot List prompted and click OK.4. Select the project to apply the imported setting in the Project List prompted and click OK.5. Select the project to import in the Import Project List prompted and click OK.6. Select the name of the setting listed in Selected Files.7. Click Import at the bottom right to import the setting. |
|---|---|

Note

NOTE:

- The exported backup file will be compressed and encrypted.
- The backup file will be exported to the path as below.
\TM_Export\ (Computer Namer + Robot ID)\Backup
- Coupler ID, Computer ID, and Robot ID will be checked while importing backup files.
- The number of the backup files on the system is limited to 5. Delete the backup files on the system if unable to import backup files.

5.8.7 Date Time

In **Date Time**, users can change the date and time of the system as well as set the time zone with the option to enable daylight saving.

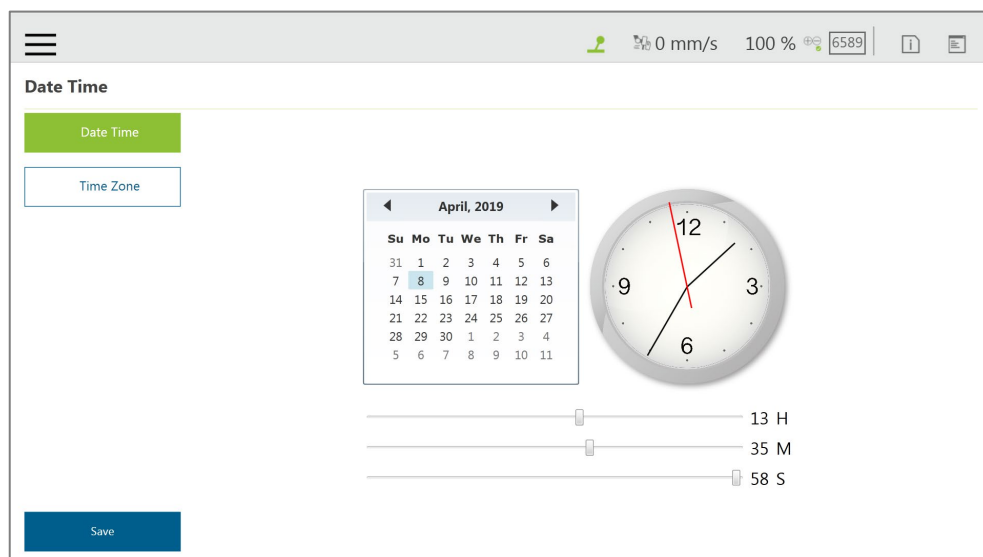

Figure 73: Date Time

5.8.8 Administrator Setting

In **Administrator Setting**, the administrator password can be changed. The default password is blank. To ensure the security of robot use and data, change the password after the first login.

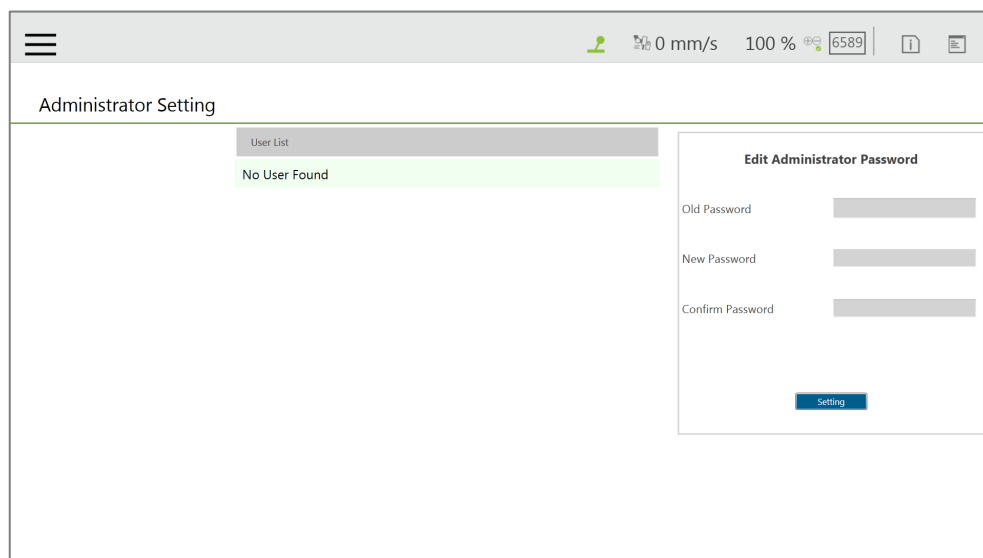

Figure 74: Administrator Setting

5.8.9 Network Service

In **Network Service**, users can upload logs, robot data, and vision images to a remote host on a timely basis with multiple connections and accounts.

To go to **Network Service**, navigate to **≡**, and click **System > Network Service**.

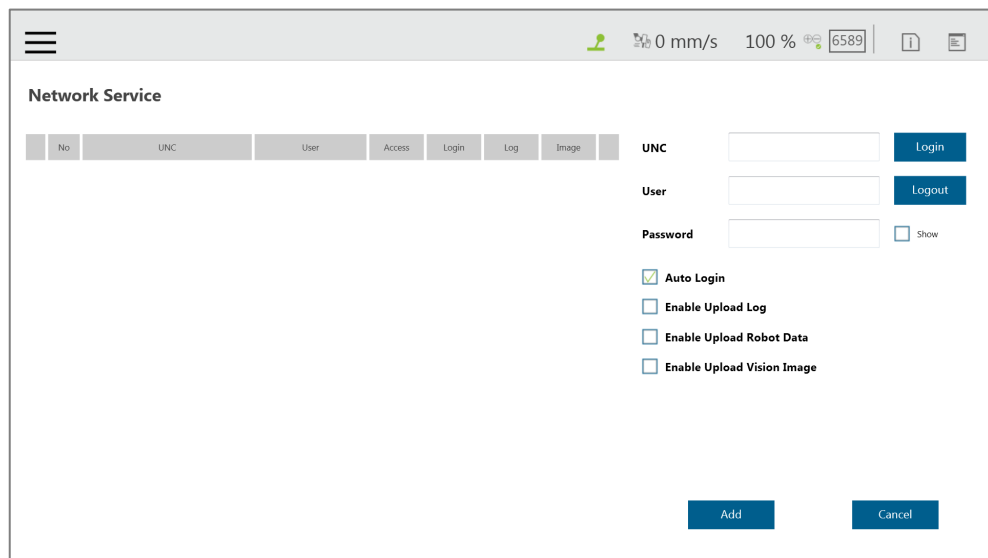

Figure 75: Network Services

To set the remote host to upload, follow the steps below.

1. In the **UNC** field, use the uniform naming convention to input the address of the remote host. If authentication is required, input the user account and the password in the respective fields. Check **Show** if you wish to see the password in plain text. Use **Login** and **Logout** to test the connection.
2. Check **Auto Login** if you wish to establish the connection when the system is on.
3. Select items to upload by checking the respective boxes, and set the interval or a specific time to upload. Check **On Error** if you wish to upload when an error occurred.
4. Repeat step 1 through 3 if you have other hosts to upload.

Note

NOTE:

Users can set FTP protocol for the connection in the **UNC** field, for example:
<ftp://test:1234@192.168.1.100:99>.

- “test” stands for the account, “1234” after the colon is the respective password, and “192.168.1.100:99” denotes the resource IP address and the port number.

To start a project to upload to the remote host, follow the steps below.

1. Navigate to **≡**, and click **Project**.
2. Start a new project or open an existing one.
3. Drag a log node to the workspace, and click the pencil icon of the node.
4. In the **Save Device** field, select the desired item in the dropdown menu, and set the directory to upload in the **Save Directory** field. Click **OK** when done.
5. Make sure the nodes in the workspace are connected properly, and run the project.

Note

NOTE:

Users have to attach the TM SSD to the system and store vision images to the TM SSD before uploading vision images via network service

5.8.10 Backup\Restore

This function allows users to backup and restore the current **TMflow** version, including projects, TCPs, robot parameters and all other contents. A backup file will be generated by clicking the **Backup** button. After users upgrade the TMflow version, the restore function can be used to restore the previous version and the file content. When executing the Restore function, it will show a window and display "**After restoring the backup file, the current data will be removed. Do you want to restore the backup file? (Yes / No)**". Click **Yes** or **No** to proceed.

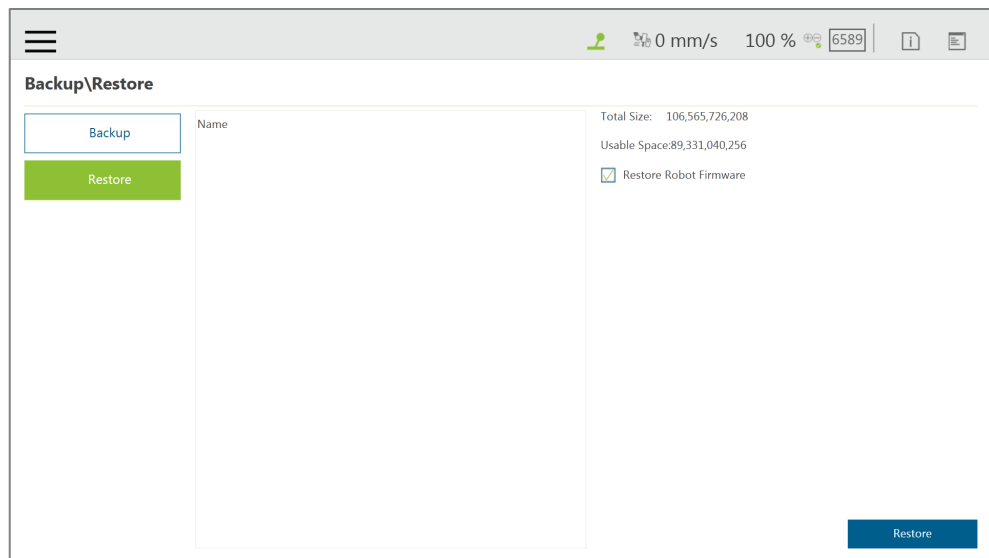

Figure 76: Backup\Restore

IMPORTANT

IMPORTANT:

The number of backup files is limited to five.

5.8.11 Input/Display Devices

5.8.11.1 Pop-out Keyboard

Check the box next to **Enable Pop-out Keyboard** and click the keyboard icon at the top right to toggle the pop-out keyboard as a means of characters input.

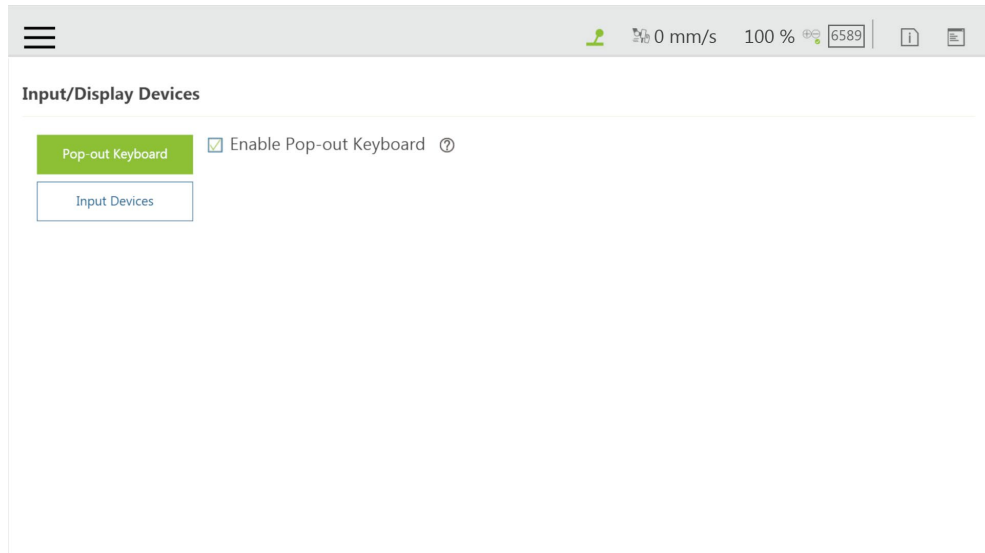

Figure 77: Pop-out Keyboard

5.8.11.2 Input Devices (HW 3.2 or newer exclusive)

This function provides users with options to set **Input Devices** with **Keyboard or Tablet** or **Pendant**. **Pendant** comes with four more hot keys, Ctrl shift P (Play/Pause), Ctrl shift M (M/A), Ctrl shift [(-), and Ctrl shift] (+), than **Keyboard or Tablet** does.

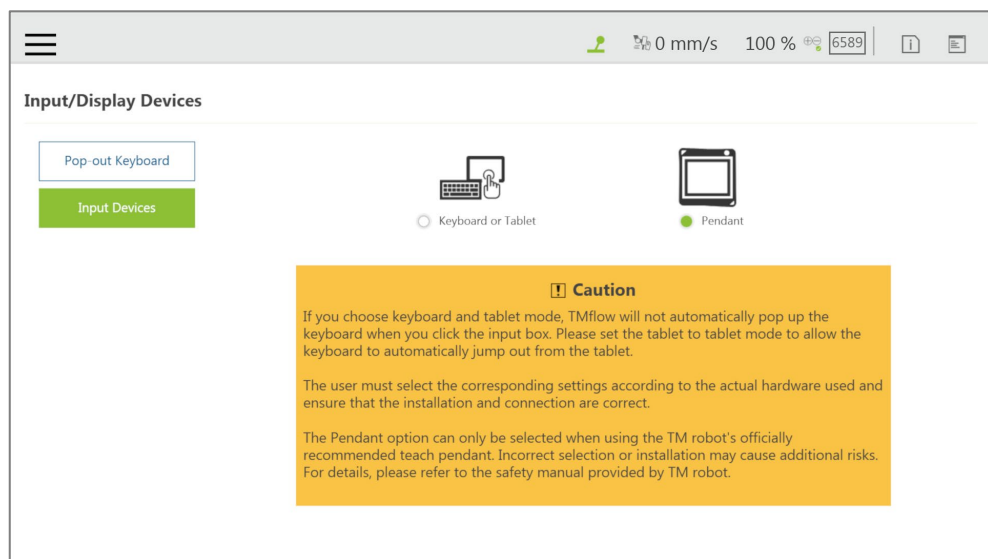

Figure 78: Input Devices

5.8.12 Auto Remote Mode

Auto Remote Mode allows users to remote control the robot with commands from external sources. Users can check the box next to **Enable Auto Remote Mode** to get the remote controller icon ready at the right of the item separator line or further check **Enter Auto Remote Mode when Boot-up** to set the system in Auto Remote Mode after the next booting-up.

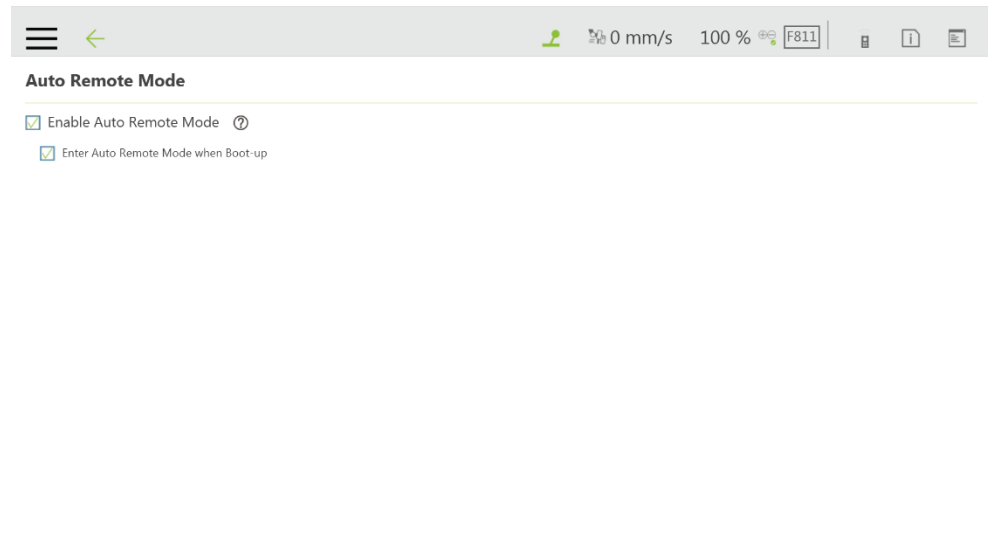

Figure 79: Auto Remote Mode (1/2)

At the right of the item separator line, a gray remote controller icon denotes Auto Remote Mode is enabled but not active, and a red remote controller icon denotes Auto Remote Mode is enabled and active. To switch between Auto Mode and Auto Remote Mode, make sure:

1. No project is running.
2. Get robot control in Auto Mode.
3. Click the remote controller icon.

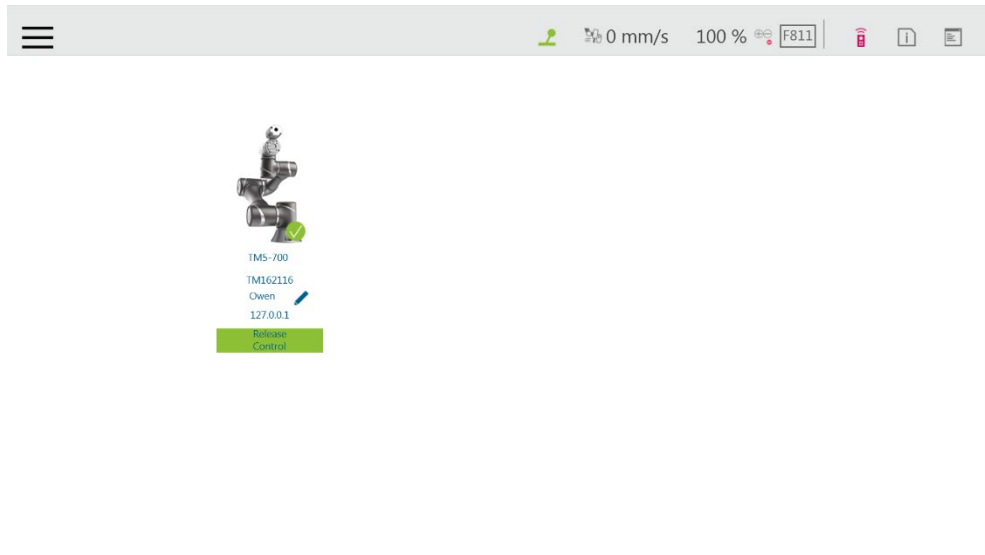

Figure 80: Auto Remote Mode (2/2)

6. Point and Base

6.1 Overview

In the projection of any point in three-dimensional space is the position of the point on the **Base**.

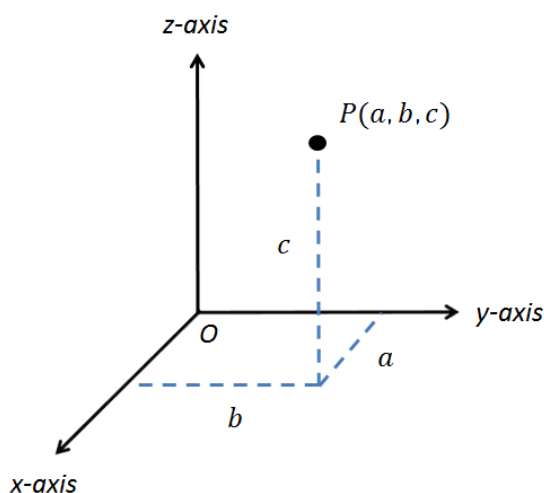

Figure 81: Base Value of the Point

To describe a point, in addition to X, Y, Z coordinate positions, it is also necessary to define its direction in the space R_x , R_y , R_z to describe the posture of the point in the space.

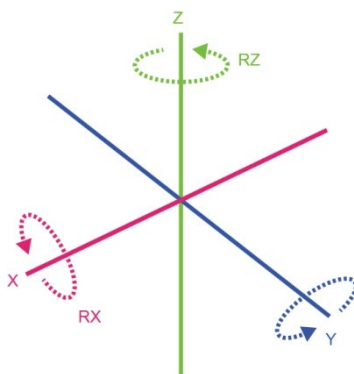

Figure 82: Coordinate Axis Rotation

The **Base** is a system that defines the corresponding position and posture of the robot in three-dimensional space. In the TM Robot, **Base** is divided into four categories: **Robot Base**, **Custom Base**, **Tool Coordinate**, and **Vision Base**.

This Chapter will introduce the basic direction judgment method for the **Base** first, and define the physical meaning of the **Robot Base**, so that users can understand the **Base** of robot, and use the controller system to move the robot in the specified **Base**. Finally, how to convert between different **Bases** will be introduced, which is for users to complete the work flow without reprogramming the project in the situation of absolute position changes while relative positions do not change.

6.2 Base and Right-hand Rule

6.2.1 Right-hand Rule

The Right-hand Rule is a method of determining the direction of the three-dimensional **Base**. In the system of **Base** of robot, the right-hand coordinate system can be used to determine the positive direction of the Z-axis, as shown in the illustration, the thumb, index finger, and middle finger represent the right hand coordinate X-axis, Y-axis, and Z-axis respectively, and three fingers are perpendicular to each other. In addition, the Right-hand Rule also determines the positive rotation direction of the coordinate axis in the three-dimensional space, bending finger. The direction pointed by the finger is the positive rotation direction of the coordinate axis.

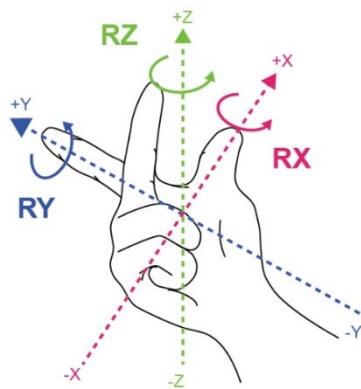

Figure 83: Right-Hand Base

6.2.2 Types of Base

The **Bases** defined in the robot are **Robot Base**, **Custom Base**, **Vision Base** and **Tool Coordinate** according to the purpose. Users can complete the point planning and application in the space using intuitive methods, according to these different base applications.

6.2.2.1 Robot Base

Robot Base is also called the world coordinate system. It is defined as the **Base** of the robot. When the robot is running, no matter how the position or posture is changed, it will not affect the direction and position of the initial point of the coordinates.

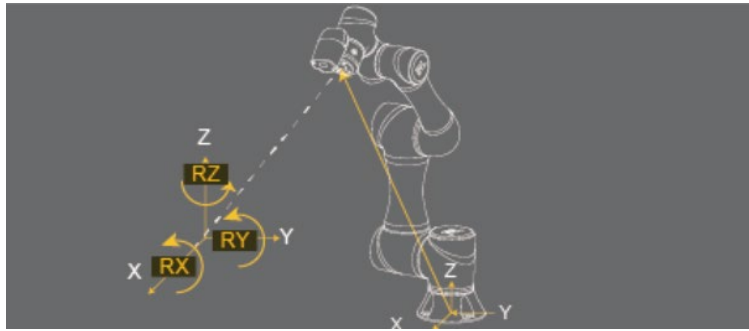

Figure 84: Robot Base

6.2.2.2 Vision Base

Vision Base can be further divided into visual servoing positioning and fixed-point positioning. The concept of visual servoing positioning is to approach the object with camera, so the **Base** is created on the camera. In fixed-point positioning, the relationship between the image coordinate and the robot is known to calculate the positioning object with absolute coordinates and its **Base** is created on the object.

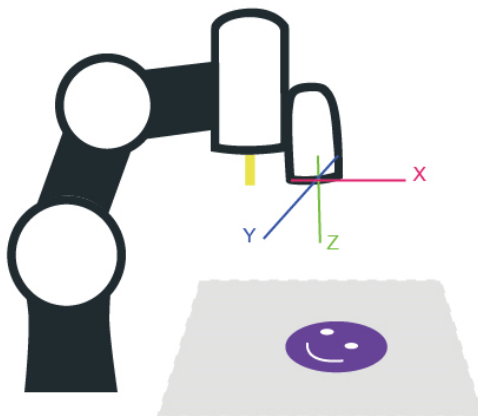

Figure 85: Servoing Vision Base is on the Camera

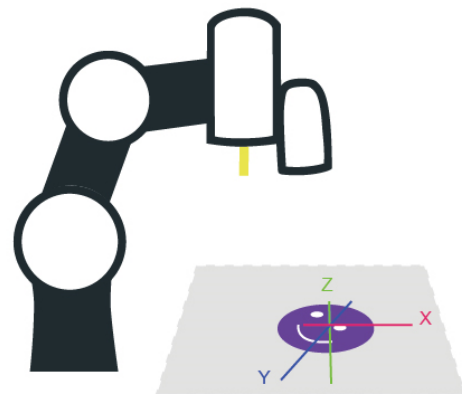

Figure 86: Fix-point Vision Base is on the Object

The robot's vision can be simply built with the **Base** in parallel to the operation plane, allowing users to complete assembly, processing, and other related applications on an inclined plane, and can also use the **Vision Base** to position the robot in the space.

6.2.2.3 Custom Base

The **Custom Base** provides users with a method for creating the reference **Base** of the motion node. Users can jog the robot to move to the origin, any point on the X-axis and XY

planes of the **Base**, to create a **Custom Base**, refer to 7.2 Create a Custom Base for details.

6.2.2.4 Tool Coordinate

Tool Coordinate is used to define the position and orientation of the robot **TCP**. Before using the **Tool Coordinate**, the orientation and posture of the **TCP** must be defined (refer to Chapter 8, "Create "). If the **TCP** is not defined, the flange center point will be used as the origin of the **Base**. In the same project, if the tool is worn out or the tool is changed, you only need to redefine the **Tool Coordinate** without having to reprogram the flow.

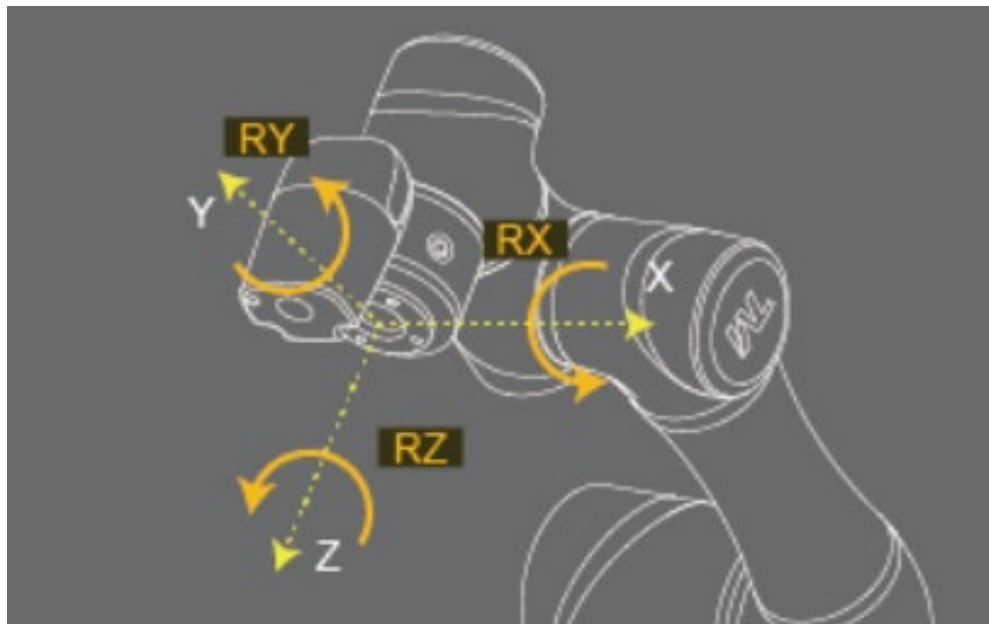

Figure 87: Tool Coordinates

6.3 Point Parameter

For the robot-defined Point Parameter, in addition to defining the position and orientation of each point, it will also regulate the recorded **Base** of each point and the tools it applies to. If the tool it applies is **T0**, represents **No Tool**.

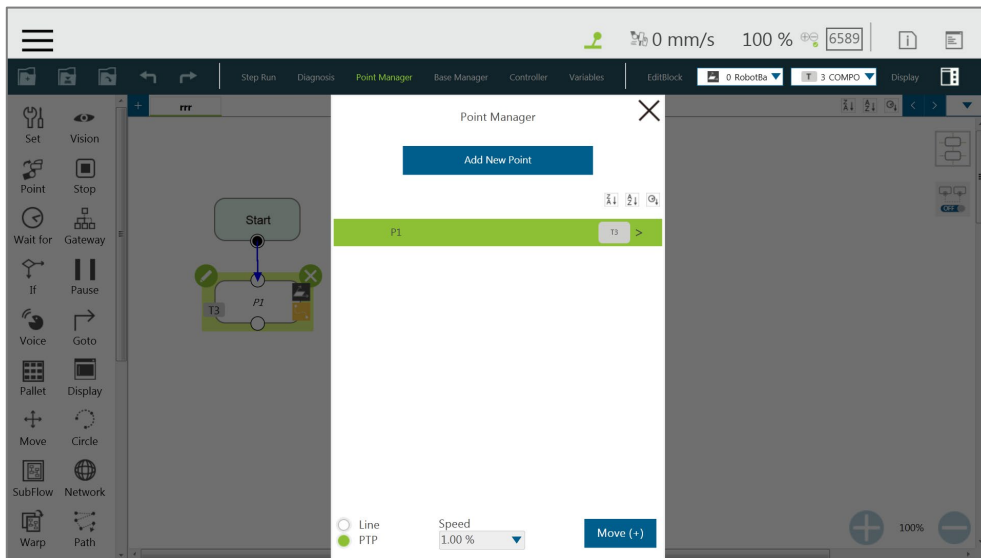

Figure 88: Point Parameter Information

If users need to apply different tools on the same project, or perform the same operation on different operation planes, different information can be reassigned to the created point. This section explains the advanced settings in the **Point** node as an example, this setting can be divided into two categories of **Base Shift** and **Tool Shift** to modify the **Base** of point and the tool applied.

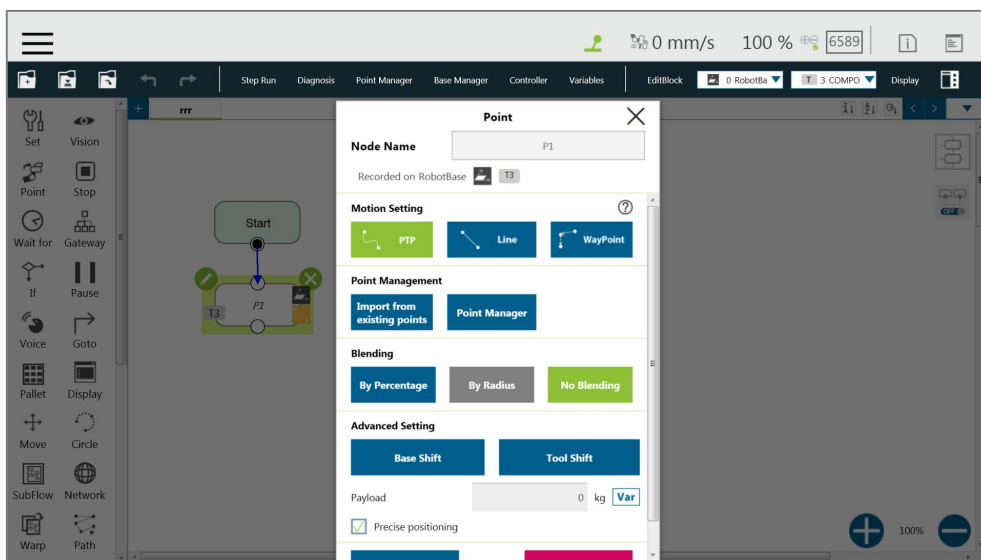

Figure 89: Shift Function of Point Node

6.3.1 Base Shift

The **Base Shift** is to transfer the point to another **Base** without changing the position and orientation of its relative **Base**. In this example, the coordinate is rotated, translated, to convert to another **Base**. In this new **Base**, the position and orientation of the point relative to its reference **Base** is not changed. In the case of change in absolute position, the relative position is

maintained. This function allows users to complete the same job on different **Bases**.

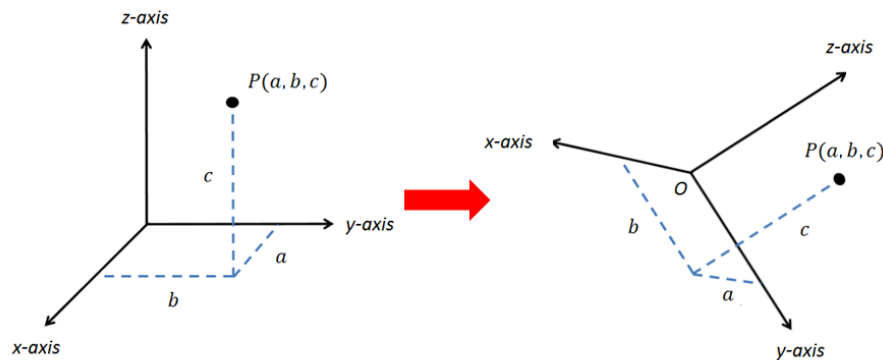

Figure 90: Base Shift Schematic Diagram

Record point P1 on Base 1. At this time, use the **Base Shift** to change the reference coordinate of the point to the new base, Base 2. This operation will not modify the data of original point, only valid for this set node, and the modified node **Base** will be presented within a pink box.

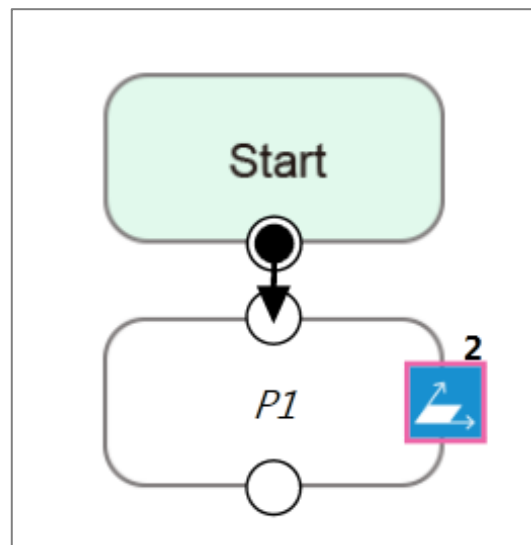

Figure 91: Node with Base Shift



IMPORTANT:

This function is different from re-record on another base in the **Point Manager**. The function of re-record on another base is to present the position and orientation of the point with respect to another **Base**. Therefore, the absolute position of the original point is not changed.

NOTE:

- **Base Shift** works on Robot Base, Vision Bases, and Custom Bases for motion nodes.
- **Base Shift** or **Tool Shift** does not reset after importing points from existing points in the node.
- **Base Shift** or **Tool Shift** is possible to shift to the current base or the current tool.

6.3.2 Tool Shift

Record point P1 on T1. At this time, use **Tool Shift** to change the tool T1 applied to P1 to tool T2. In practical applications, this function can be used if the tool is worn out or the same path is completed using different tools. This function is divided into two categories: **Keep Pose** and **Keep Path**. The same as the **Base Shift**, this operation does not modify the data of the origin position, is only valid for this set node, and the tool icon of the modified node will be rounded with pink borders.

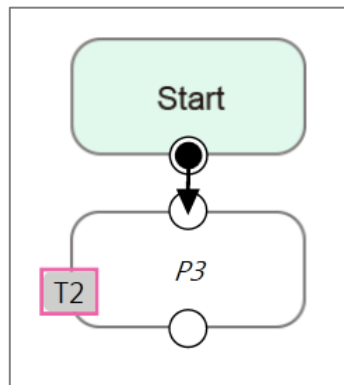

Figure 92: Node with Tool Shift

- **Keep Pose:** If the tool selected when the robot records the path is incorrect, the **Keep Pose** function of **Tool Shift** can be used to substitute the correct tool parameters of this node. This setting will not cause changes to the robot's pose and position, that is, it overlaps with the original track when running the project.

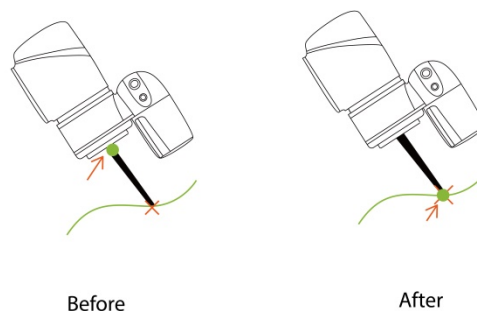

Figure 93: Tool Shift Using Keep Pose

- **Keep Path:** The robot will try to make the point recorded with the new tool the same as the old tool's point, and further change the robot's pose to conform to the new tool's setting; however, it may not be achieved due to space or robot mechanism limitations.

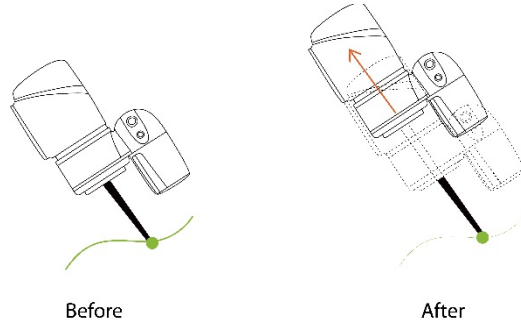

Figure 94: Tool Shift Using Keep Path

7. Create Base

7.1 Create Vision Base

Vision Base can be generated through **Vision** Node in the Flow, which can be defined based on the target object or on the camera depending on which method is being chosen (Servoing or Fixed-Point).

7.2 Create a Custom Base

Click on the Base Manager above the **Project Editing Page**. Users can use three points to create a new **Base**. Since the information of each point is recorded on the **Base**, only three points need to be redefined when changing the work plane. It is possible to implement the motion on another plane without reprogramming.

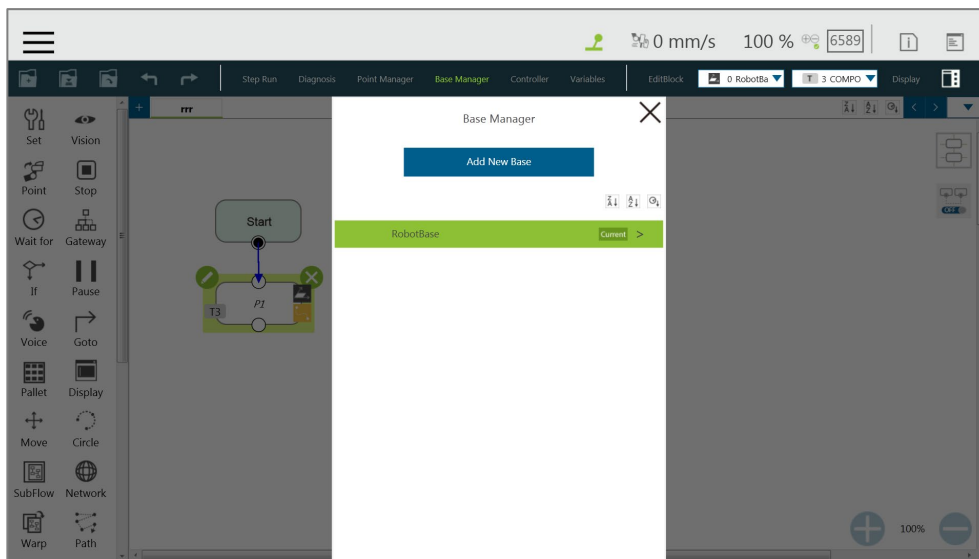

Figure 95: Base Manager

There are three buttons in the center of the three-point **Base**. From left to right, they are **Set the Base Origin**, **Set any Point on X-axis of the Base**, and **set the Base on any Point on the Positive X - Positive Y Plane**. Refer to 6.2 Base and Right-hand Rule to use the **Base** correctly.

Users can use the controller button below to enable the controller to operate the robot, or use the **FreeBot** mode to pull the robot to the target position (“Pointing 0,0,0”, “Point on X-axis”, “Point on Surface”). Pressing the corresponding button at this time will record the robot's current position at this point. After the setting is completed, the exclamation mark in front of the button will disappear. Once all three points are set, press "OK" to create the **Base**.

Note

NOTE: Build a **Base** by 3 Points

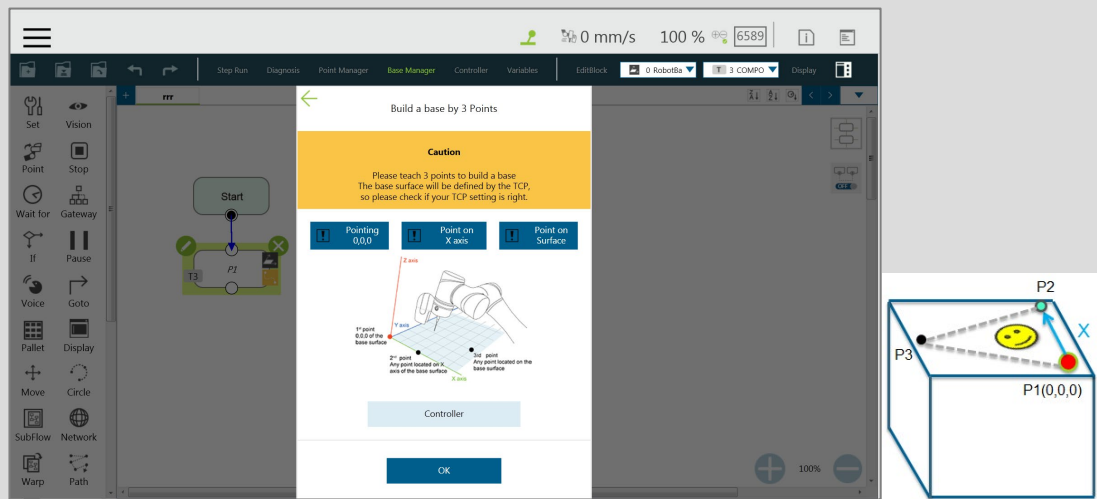

Figure 96: Build a Base by 3 Points

There are 3 buttons representing the 3 points which define a base, i.e. **Origin (0,0,0)**, **Point on X-axis**, and **Point on Surface**, refer to 6.2.1 Right-hand Rule.

Users can use the controller button below to enable the controller to operate the robot, or use the **FreeBot** mode to pull the robot to the target position (Pointing 0,0,0, Point on X-axis, and Point on Surface). Press the corresponding button at this time will record the robot's current position at this point. After the setting is completed, the exclamation mark in front of the button will disappear. After all three points are set, press **OK** to create the base. This point is the TCP point.

7.3 Create New Base Node

Drag the **New Base** Node from the left side. After clicking Edit on the upper left of the node, users can select to create a new base with vision bases or create a new base with three points.

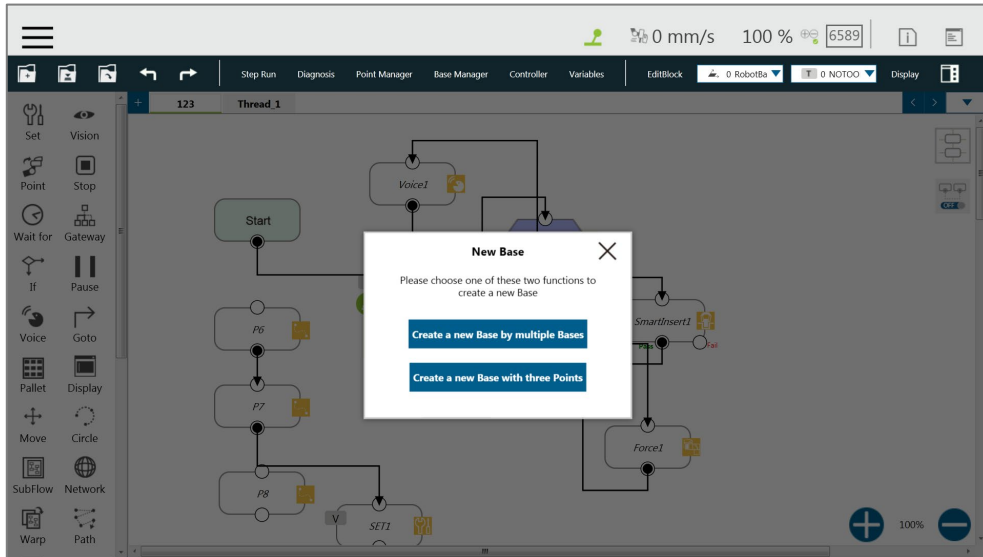

Figure 97: New Base Node

7.3.1 Create a New Base by Multiple Bases

7.3.1.1 Create a New Base with Two Vision Bases

This function is to create a new **Base** with two **Vision Bases**. While the project is running, if the relative distance between the two updated **Vision Bases** fall within the tolerance range set by users, it is possible to create a new **Base**, or the node will go to the path of fail.

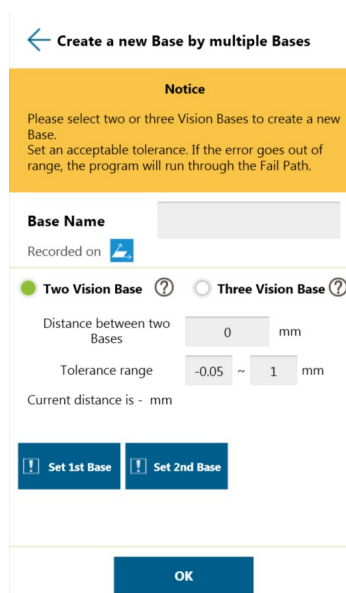

Figure 98: Create a New Base with Two Vision Bases

7.3.1.2 Create a New Base with Three Vision Bases

This function is to create a new **Base** with three **Vision Bases**, and use the position of the first **Vision Base** as the initial position, the second **Vision Base** to set the direction the x axis,

and the third **Vision Base** to set the fiducial orientation. Since this function only uses the position to create the new **Base**, it cannot be affected by the error of the visual recognition angle, and it is applicable to situations where the angle is required to be highly stable. While the project is running, users can set the tolerance ranges of the initial position to the second **Vision Base** and the third **Vision Base**. If the calculated distance falls within the tolerance range set by users, a new **Base** will be created, or the node will go to the path of fail.

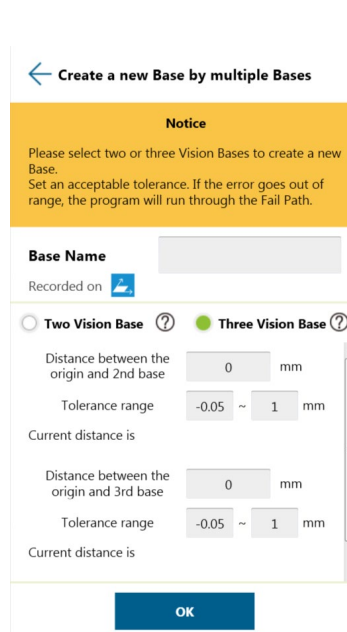

Figure 99: Create a New Base with Three Vision Bases

7.3.2 Create a New Base with Three Points

This function is to create a new **Base** with the three points such as the points on the **Vision Bases**, the **Dynamic Points**, and the points in general to be used together. The two common situations create a new **Base** with three points on the **Vision Base** and create a new **Base** with three **Dynamic Points**, are described below.

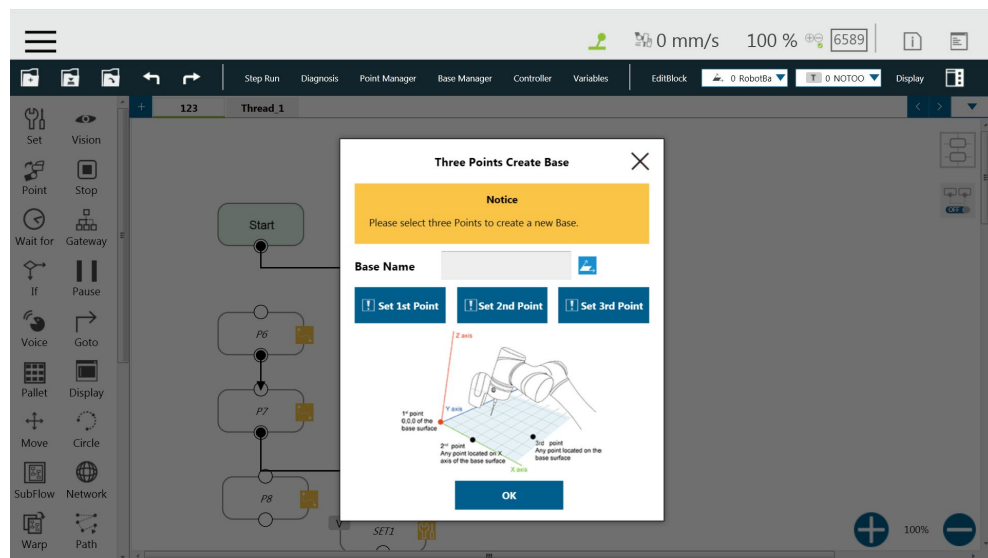

Figure 100: Create a New Base with Three Points

7.3.2.1 Create a New Base with Three Points on the Vision Base

In situations where it is not possible to create a new **Base** by visual recognitions, users can create a new **Base** with the points recorded on the **Vision Bases**. By using the **New Base** node, it is possible to launch the **Point Manager** and use the points in the **Point Manager**. The first selected point sets the initial position of the **Base**, the second selected point sets the direction the x axis, and the third selected point sets the fiducial orientation. As illustrated below, P1, P2, and P3 are applied to create a new **Base**. Since the points are recorded on the **Vision Base**, the newly created **Base** changes as the **Vision Base** changes.

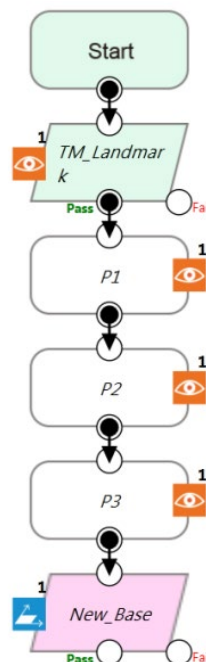

Figure 101: Create a New Base with Three Points on the Vision Base

7.3.2.2 Create a New Base with Three Dynamic Points

Rather than using points on the **Vision Bases**, this function uses the **Dynamic Points** built by the **Touch Stop** nodes to create a new base. In situations where it is not possible to create a new **Base** by visual recognitions, users can create a new **Base** with the **Dynamic Points** built by three **Touch Stops**. The first **Touch Stop** sets the initial position of the **Base**, the second **Touch Stop** sets the direction the x axis, and the third **Touch Stop** sets the fiducial orientation.

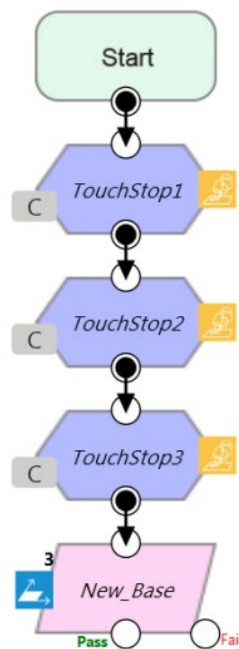

Figure 102: Create a New Base with Three Dynamic Points

8. Create the TCP

8.1 Overview

The **TCP** (Tool Center Point) is the reference point for tool interaction with the workpiece. The **TCP** includes six parameters: X Coordinate, Y Coordinate, Z Coordinate, Rx Coordinate, Ry Coordinate, and Rz Coordinate. The **TCP** is attached to the end of the robot, and is referenced from the center coordinates of the flange.

On the robot, apart from the position and orientation reference values of the six elements, the tool weights and the inertia values can also be input to compensate the performance during operation to avoid misreading the effect of the tool on the robot as an external force. The **TCP Setting** can be accessed from the **Robot Setting page**.

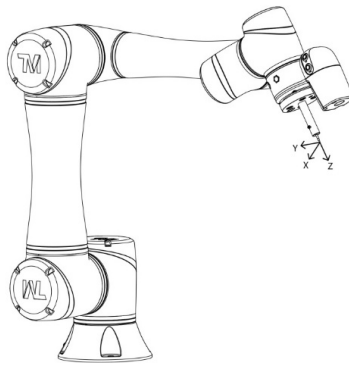

Figure 103: TCP Definition

8.2 TCP Setting

This section describes how to get parameters of **TCP** from "**Teaching**" or "**Manual Input or choose from Saved File**".

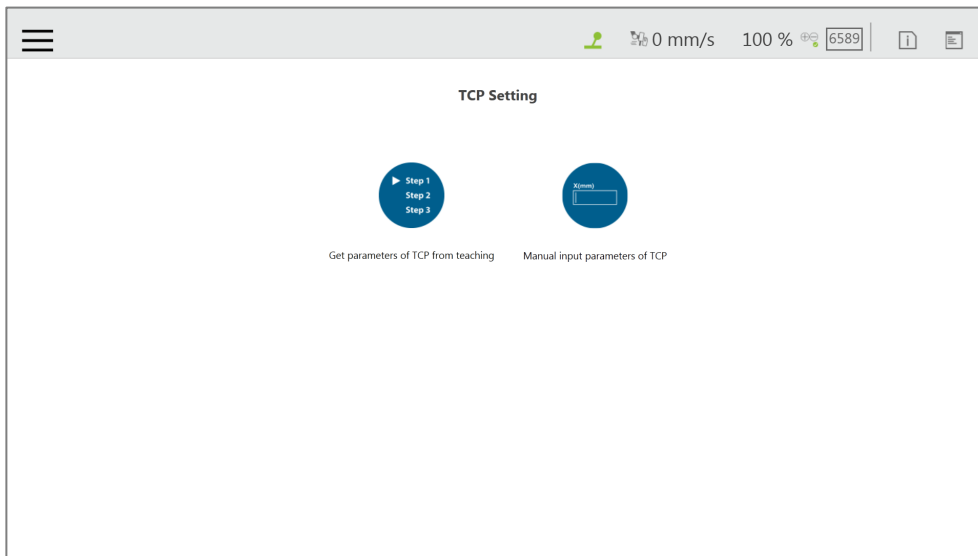

Figure 104: TCP Setting

8.2.1 Create Parameters of TCP with Hand Guidance Teaching

The principle of creating the **TCP** by teaching is to teach the robot to reach the same point in the space through a different posture, to calculate the position of **TCP** relative to the robot end flange automatically. The **Calibration Pin Set** sold by the Corporation or a custom-made calibration tool can be used to calibrate the fixed calibration point in the space during the teaching process. The number of calibrations varies depending on users' operation method and accuracy requirements. The number of teachings on the **TCP** is at least 4 times.

Follow steps below to create a **TCP** by teaching:

1. Set the times of calibration and the mass of tools

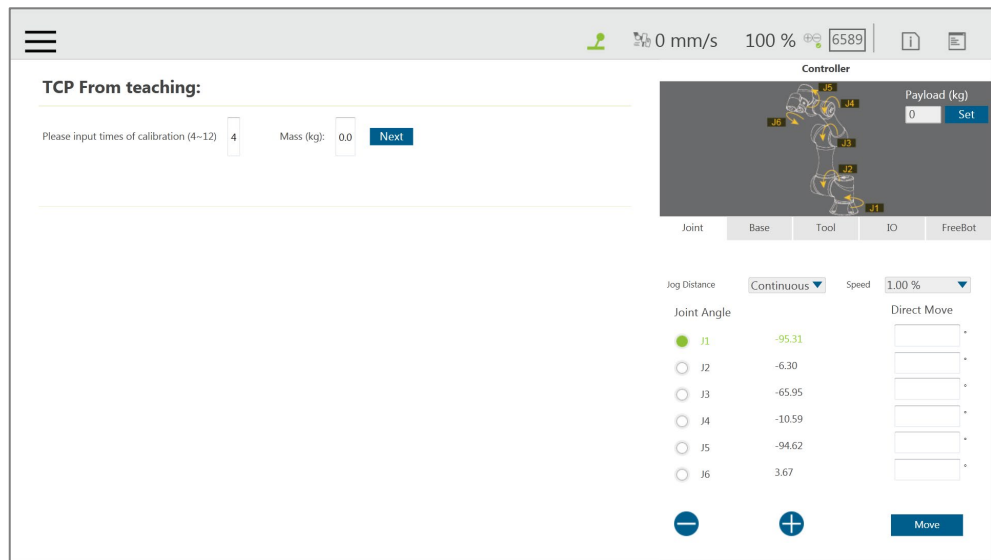

Figure 105: Set the times of calibration

The position of the **TCP** is clearly marked on the tool. In this example, the tool is a **Calibration Pin Set**, and the **TCP** is located at the tip of the needle.

2. Fix the **Calibration Needle** on a solid surface.



Figure 106: Teaching Screen

3. Align the end of tool to the calibration point by teaching, and follow by clicking the record on the screen.



Figure 107: The Robot Posture Needs to Change during Teaching (1/2)



Figure 108: The Robot Posture Needs to Change during Teaching (1/2)

4. Repeat this action until completed and the **TCP** numerical results and error values are displayed. After confirming that there is no mistake, input the tool name to save the file, and set it as the current tool for the robot.
5. After teaching is completed, the positioning result will be displayed.

Note

NOTE:

It is recommended to calibrate this value equal or less than 0.3 to ensure accuracy.

IMPORTANT

IMPORTANT:

In addition to users' human errors and the number of calibrations, the error of establishing a **TCP** by teaching is also related to the selected teaching poses. The more joints that you change, and the more you change each one, the better. Between each teaching point, rotate each joint, to achieve the best calibration result.

Note

NOTE:

When using the **Calibration Pin Set** to teach **TCP**, the controller can be used to fine-tune the moving robot. Between each teaching point, it is still necessary to ensure that 1 to 6 joints are rotated.

- 6. The calibration result can be saved for future use.

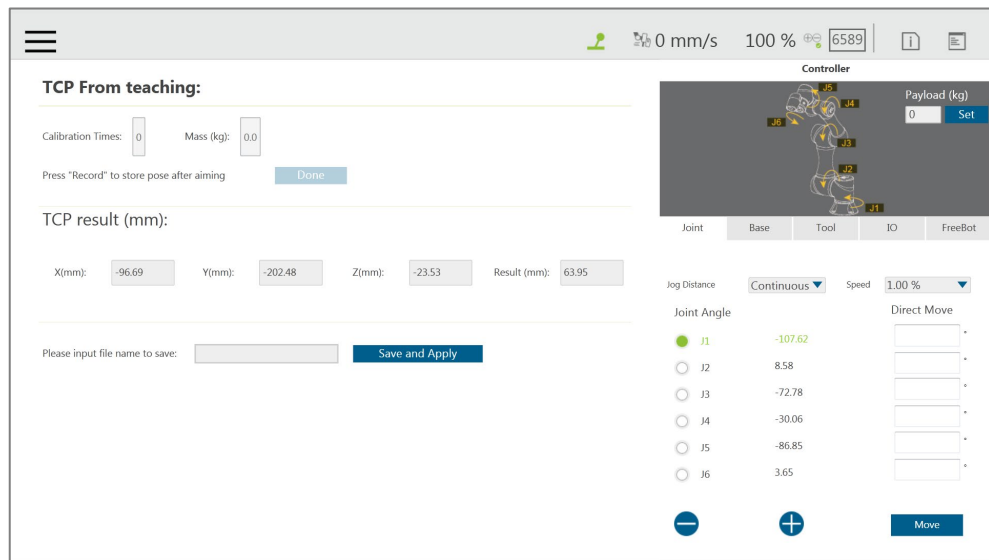

Figure 109: Save Teaching Result

8.2.2 Create Tool Center Point by Input Parameters

If users clearly know the **TCP** relative to the position of robot end flange, the coordinate parameters can be input manually. After the input is completed, click **Save as** to create a new **TCP**. To modify the **TCP** parameter values, click **Open** to select the item to be modified from the list, and after the modification is completed, click **Apply** in the lower right corner to save the changes and set this **TCP** to the current **TCP** to be used by the robot. In this interface, all **TCP** data on the robot can be managed. Click **Open** to open the **TCP** list of the robot. Click **✖** behind the item to delete the **TCP** data.

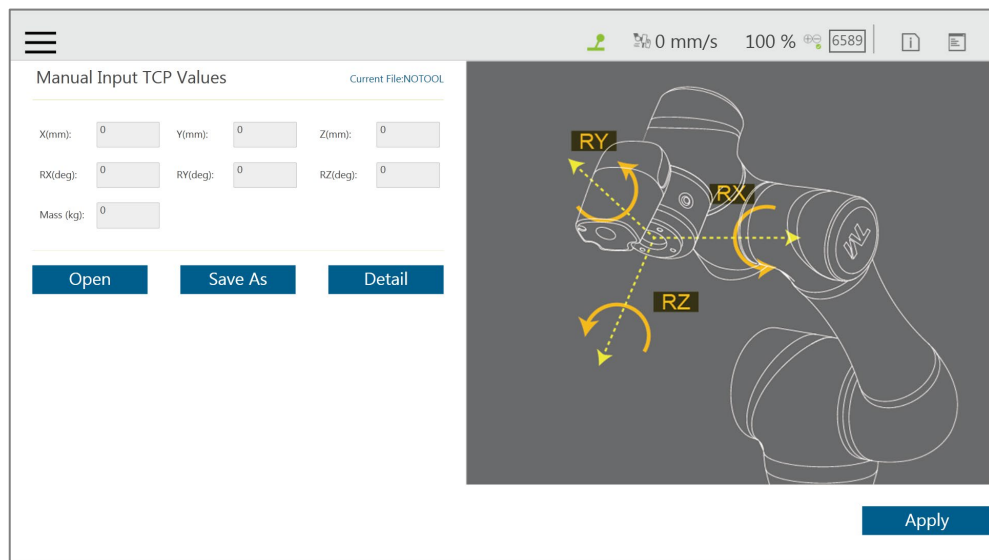

Figure 110: Manual Input TCP Values

9. Motion Programming

9.1 Overview

This chapter will introduce the robot's commonly used motion nodes, describe its basic features and motion modes, and help users understand blending.

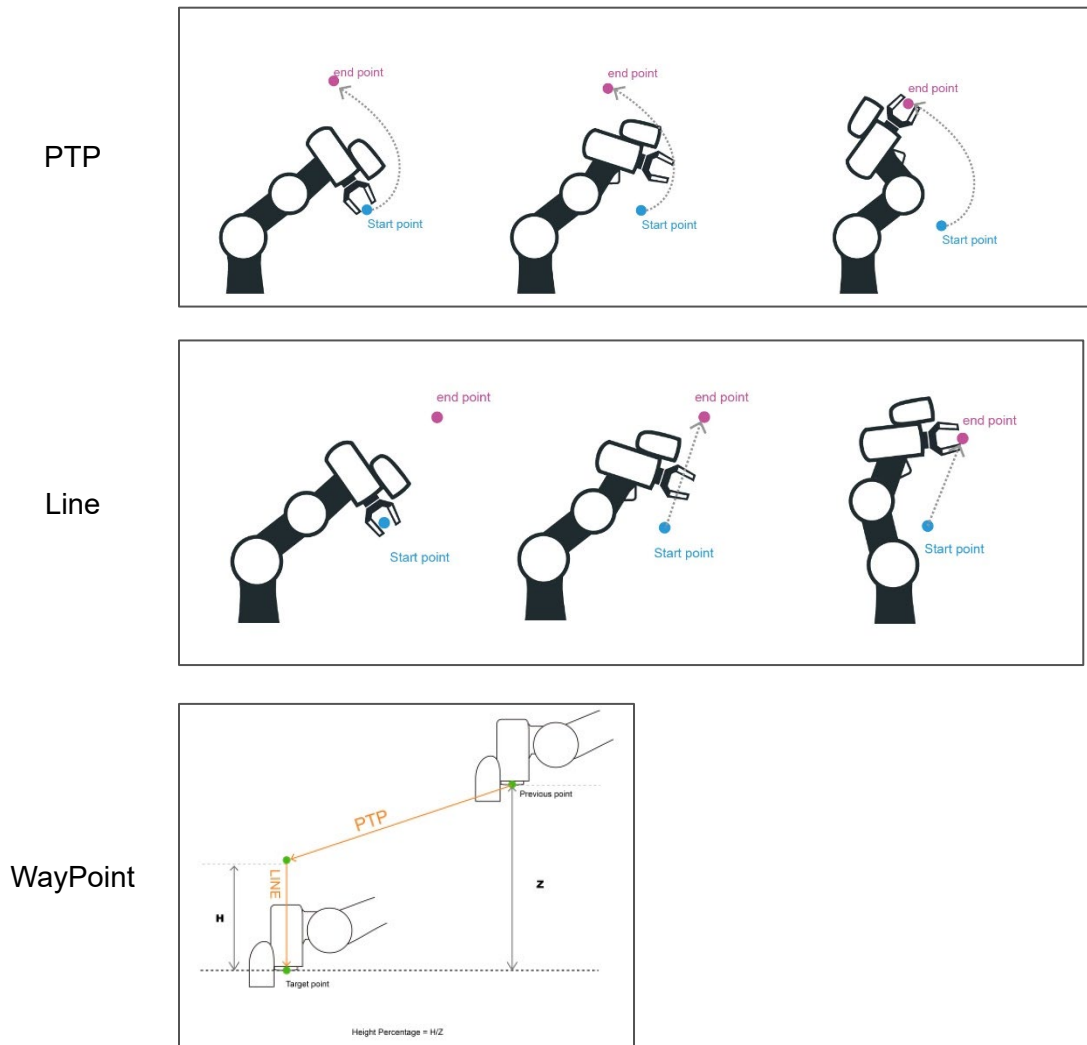
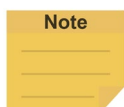

Figure 111: TM Robot Motion Types

- **PTP (Point to Point):**
The robot moves to the target point along the closest path of the joint angle space
- **Line:**
The tool moves in a straight line at the specified speed



NOTE:

User can set PTP and Line speed via variables. However, the motion of the point node comes with the issues of mixing trajectories because the point node must calculate the motion commands in advance. Accordingly, if the speed variable of the point node is changed in other threads, the speed of the robot will not be the current value of the variable.

To ensure the correctness of the speed variable in the motion command with the point node, users need to add a Wait For node or update the speed variable ahead of the point node in the same flow.

- **WayPoint:**

The tool performs two-stage path movement at the set percentage of Z-axis height or distance, and it is often used for pick and place applications.



NOTE:

To maintain the smoothness and the continuity of the motion, the flow in process calculates and sets each value in the nodes with the logic and the sequence of the programming. The calculation is made much earlier than the time to actually perform the motion. If using variables as the parameters in the motion nodes, users must insert other nodes such as the Set nodes, the Network nodes, or the Listen nodes before the motion node to assign the correct values to the variables.

9.2 Point to Point (PTP)

9.2.1 PTP is the Fastest Way to Move

The PTP mode determines the robot's motion by calculating the angular variation of each axis, and is not limited by the singularity point. If the robot's motion is not limited, it is recommended to select PTP movement.



IMPORTANT:

Singular points are described in the *Safety Manual*.

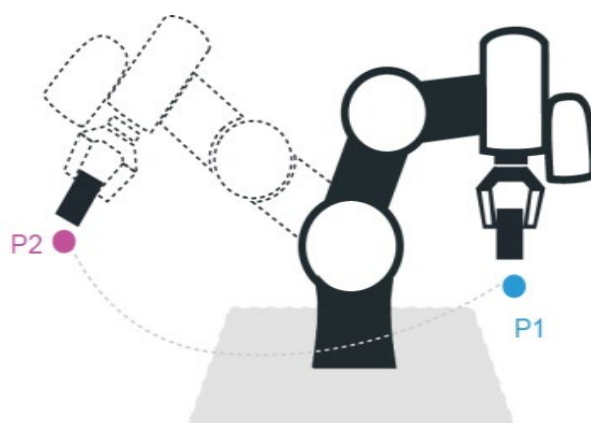

Figure 112: PTP Motion

9.2.2 Speed of PTP Motion

The PTP speed is based on the motion joint that takes the longest time. The PTP mode may

cause the TCP to exceed speed limit, especially when the arm length is longer, and should be avoided. Speed percentage and time to top speed can be set in PTP speed setting.

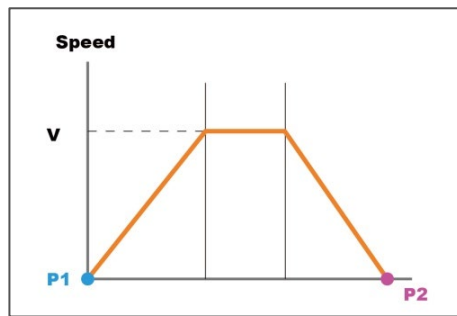

Figure 113: Speed of PTP Motion

9.2.3 Plan for PTP Movement

In the example, working with the TCP T4 to move the workpiece from P1 to P2 does not need to limit the robot movement path, using the PTP setting at the P2 Point node, after the robot reaches P1. In this case after the arm reaches P1, the fastest movement path will be planned to move to P2.

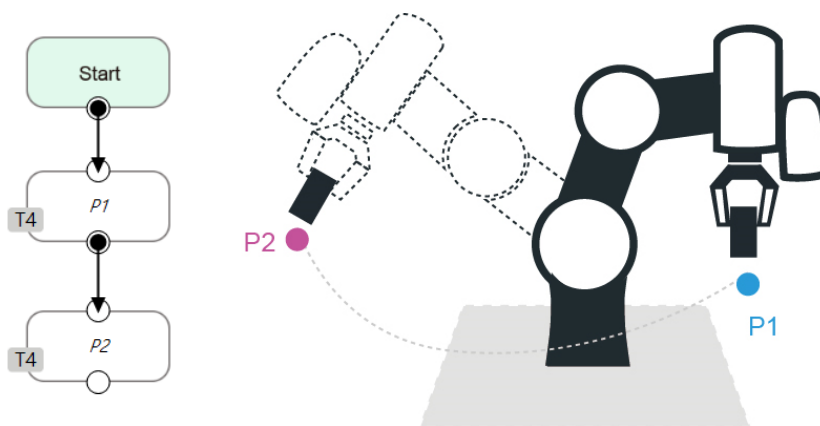

Figure 114: PTP Application Examples

9.2.4 PTP Smart Pose Choosing

By default, in PTP motion, the system will choose the configuration determined from the recorded robot pose and move to the target point. This feature has the system ignore the configuration from recorded robot pose and choose the most efficient configuration on the way to the goal. This feature is applicable to **Vision**, **Point**, **F-Point**, and **Path**. However, it is not applicable to **Move** and **CV Point**.

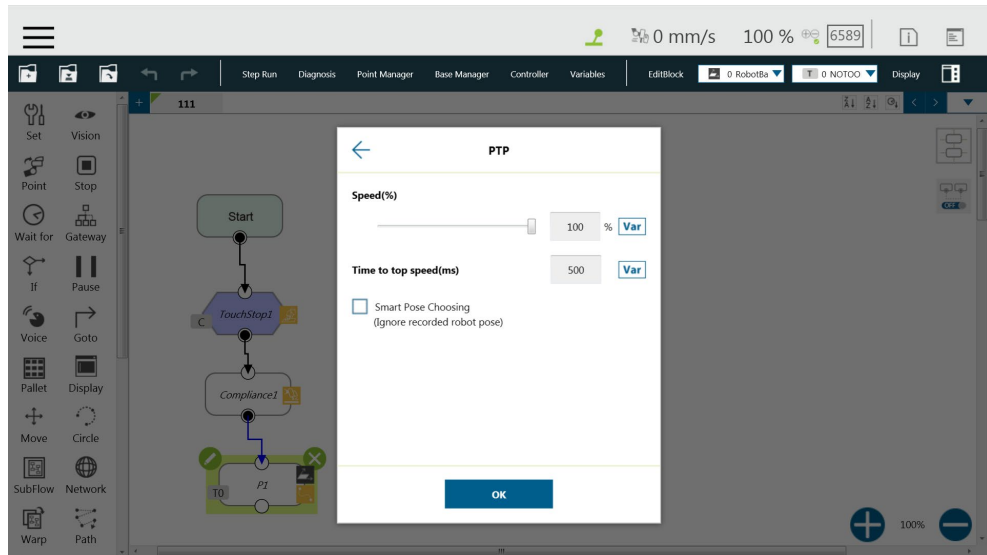

Figure 115: PTP Smart Pose Choosing

9.3 Line

9.3.1 Line Moves the Shortest Distance

A straight line is the shortest distance between two points. The Line mode specifies that the path between the two points is planned as a straight line.

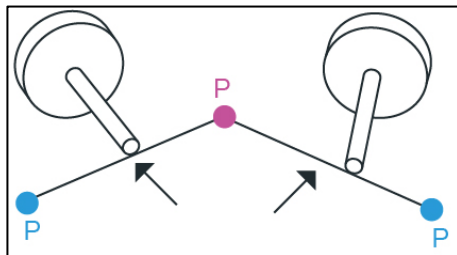

Figure 116: Line Motion Simulation

9.3.2 Speed of Line Motion

Line mode may cause joint speeding. Try to avoid speeding close to a singularity point, or make the posture large-angle movements over a short distance.

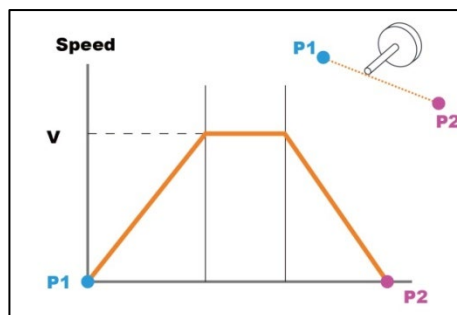

Figure 117: Speed of Line Motion

Percentage of Typical Speed and absolute speed value can be set in Line speed setting. The available range of **ABS Speed** is from 0 to 4500 mm/s, and the available **ABS Time to top speed** is from 150 to 9999 ms. Check the box next to **Link to project speed** to align the speed with the project speed.

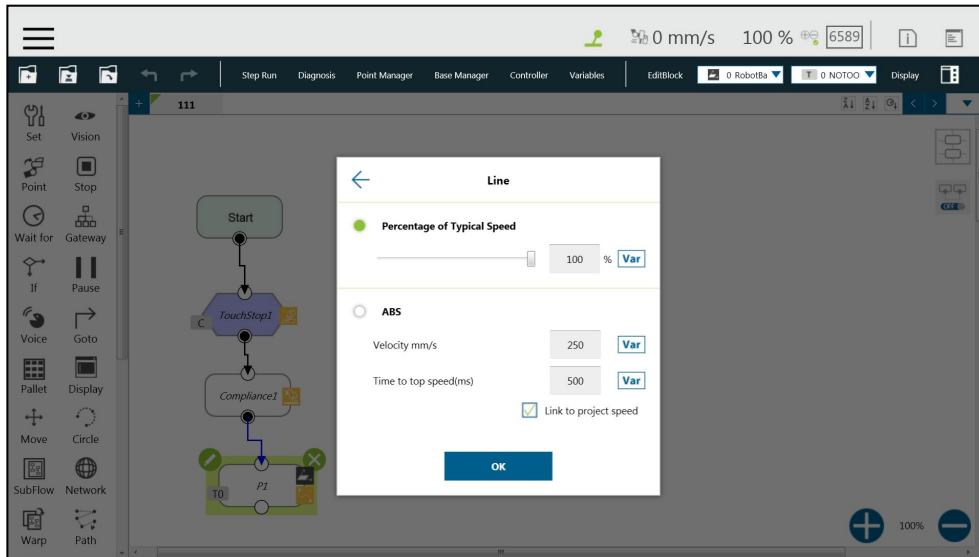

Figure 118: Link to Project Speed

The **typical speed** is the suggested maximum speed of a regular application, and is the linear speed of the center of the tool flange of the robot, used in the specified cycles defined in these specifications:

- Repeatability
- Maximum Payload

If users want to set higher speed, use the **ABS** setting in the node. The maximum speed of the robot is highly dependent on the pose of the robot and joint motion. Refer to the maximum joint speed in the specification for the composition of velocities of the tool end.

9.3.3 Plan for Line Movement

The figure below explains that this project sets two points P1, P2, and tool T22. Using the Line setting at the P2 **Point** node, after the arm reaches P1, it will move to P2 with Line path.

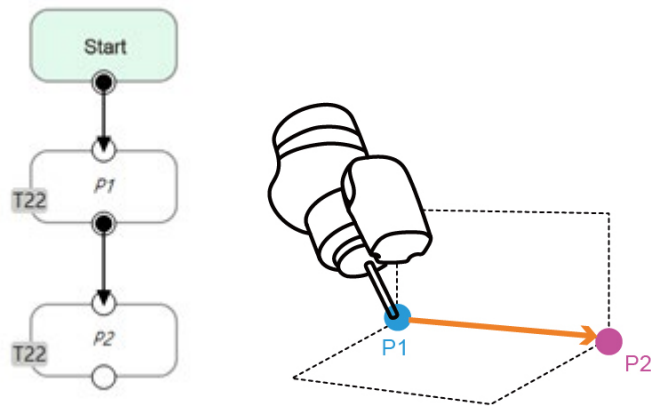

Figure 119: Line Application Example

IMPORTANT

IMPORTANT:

ABS (Absolute) speed setting, including **Point**, **Path**, **Move**, and nodes can be used when the speed is linked with **Project Speed**. When not clicked, the arm motion maintains the ABS set speed. The warning window will pop up when the speed setting exceeds 250mm/s, and check automatically, display "**Speed exceeds 250mm/s, needs to be linked with Project Speed**".

9.4 Two-Steps Motion (WayPoint)

9.4.1 WayPoint

The two-step movement will maintain a part of Z-axis displacement on the point **Base**. When the 1st step XY axis is aligned and in position, the 2nd step will move toward the Z-axis. This is often used in pick-and-place applications. To plan the motion from the 1st step to the 2nd step, users can choose either **PTP to Line** or **Line to Line** motion.

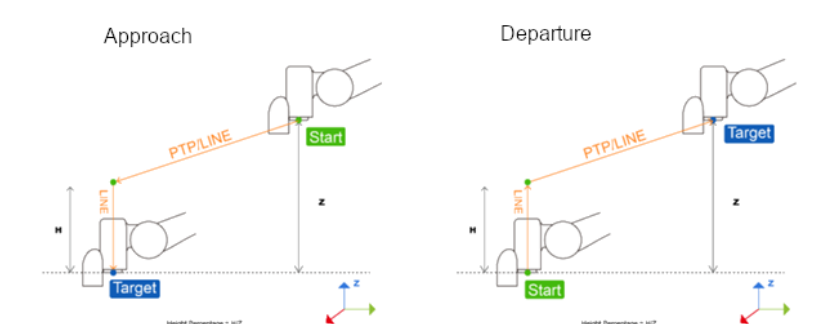

Figure 120: WayPoint Motion Status

The movement is taken as approaching motions with moving sequence from the 1st step to the 2nd step when the target point direction is on the direction of +Z in the tool coordinate, and the movement is taken as leaving motions with moving sequence from the 2nd step to the 1st step when target point direction is on the direction of -Z in the tool coordinate.

The approach and departure of the WayPoint motion is set by the system automatically with the

following criteria:

- For approaching motions, users have to set the target point on the same direction as the Z-axis of the robot's tool coordinate with the starting point.
- For departing motions, users have to set the target point on the opposite direction from the Z-axis of the robot's tool coordinate with the starting point.

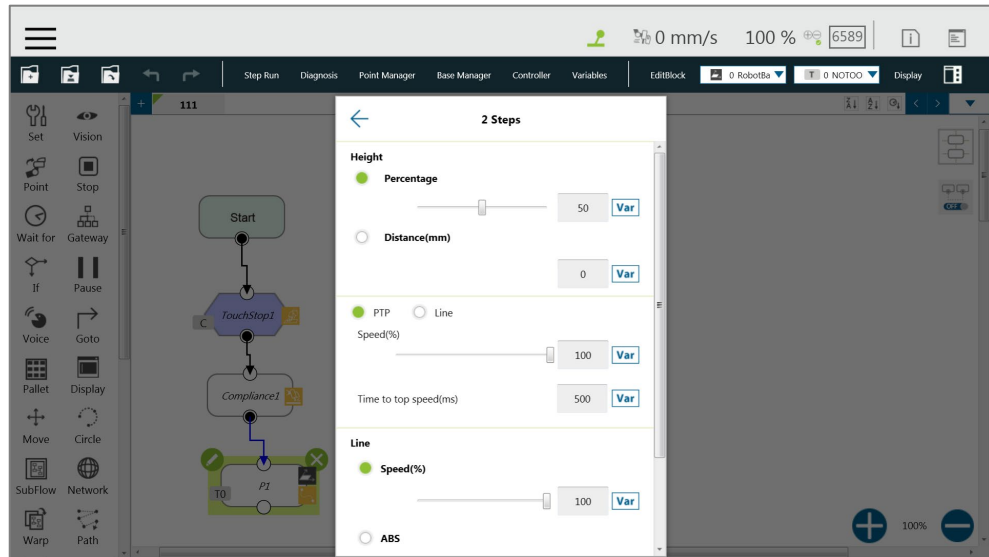

Figure 121: WayPoint Setting

Users can set the value of **Percentage** with the slider or the respective field, or **Distance** in mm to maintain height with the respective field. Also, users can use the **Var** button to set the value with a variable. If the variable for percentage is larger than 100, the system uses 100. If it is smaller than 0, it equals to 0. The data type of the variable must be integer.

9.4.2 Plan for WayPoint Movement

The following figure is an example to illustrate that if there are obstacles around the workpiece to be picked, extra care is needed to avoid a collision. This project creates a point P1, sets the WayPoint motion mode, retains a Z axis height before reaching P1 point, and then goes downward to pick the workpiece, to prevent a collision.

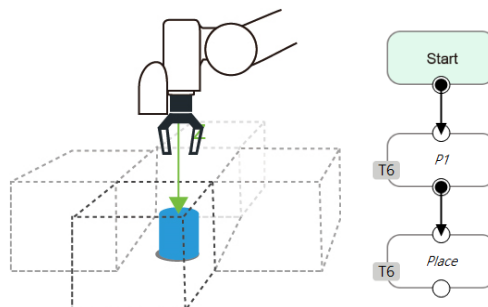

Figure 122: WayPoint Application Examples

9.5 Blending

Note

NOTE:

The robot cannot use blending before going to a WayPoint node.

9.5.1 Blending in Movement

In the process of planning a trajectory, the robot will not exactly pass through each programmed point, which has the advantages of reducing the number of robotic brakes and reducing wear and shortening the cycle time. As shown in the figure below, a movement from P1 to P3 is planned, and P2 does not need to be exactly in the path. In this case, **Blending** can be set at P2 point.

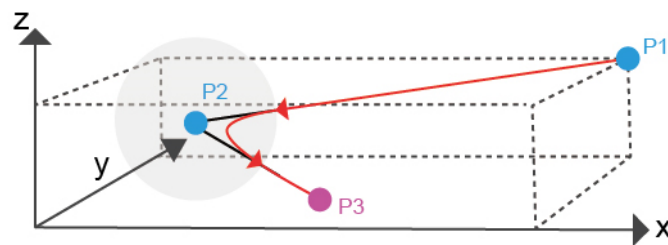

Figure 123: Blending in Space

9.5.2 Blending Speed Change Chart

The cycle time can be shortened by Blending as shown in the figure below.

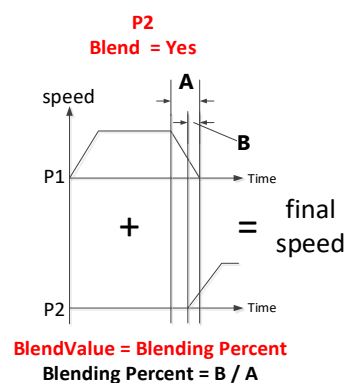

Figure 124: Blending Speed Change Chart

9.5.3 Set the Blending Percentage

Users can click **By Percentage** to set the blending percentage in Line, PTP, and Circle motion modes.

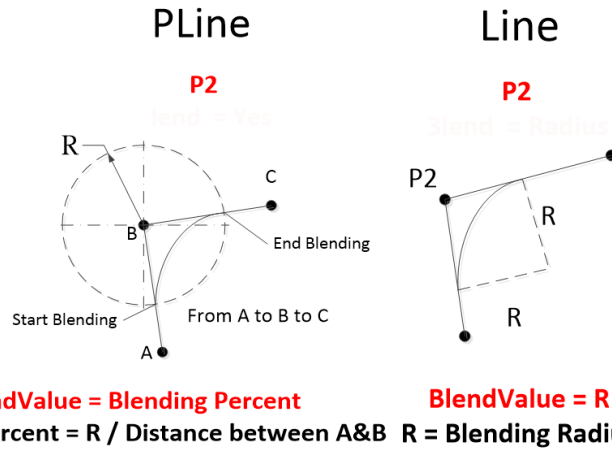

Figure 125: Set the Blending Percentage or Set the Blending by Radius

9.5.4 Set the Blending by Radius

In Line mode, users can click **By Radius** to set the **Blending** by radius. Line is a commonly used motion mode in Point Nodes. For details, refer to the sections with corresponding titles of this manual.



IMPORTANT:

As shown in the table below, blending can improve the smooth running of robot, but when the **Blending** radius has been set by Line motion, blending with Circle and PTP cannot be used.

	P2 P1	PLine	Line		PTP	Circle
			%	Radius		
	PLine	X				
Line	%		X	X	X	X
	Radius		X	X		
	PTP		X		X	X
	Circle		X		X	X

Table 7: Valid Blending Setting (Moving from P1 to P2)

9.6 Motion Nodes

Payloads of motion nodes support variables as inputs. The available data types of the variables include integer, float, and double. This feature is applicable to **Point, Pallet, Move, Circle, Path, F-Point, Compliance, Touch Stop, and Force Control.**

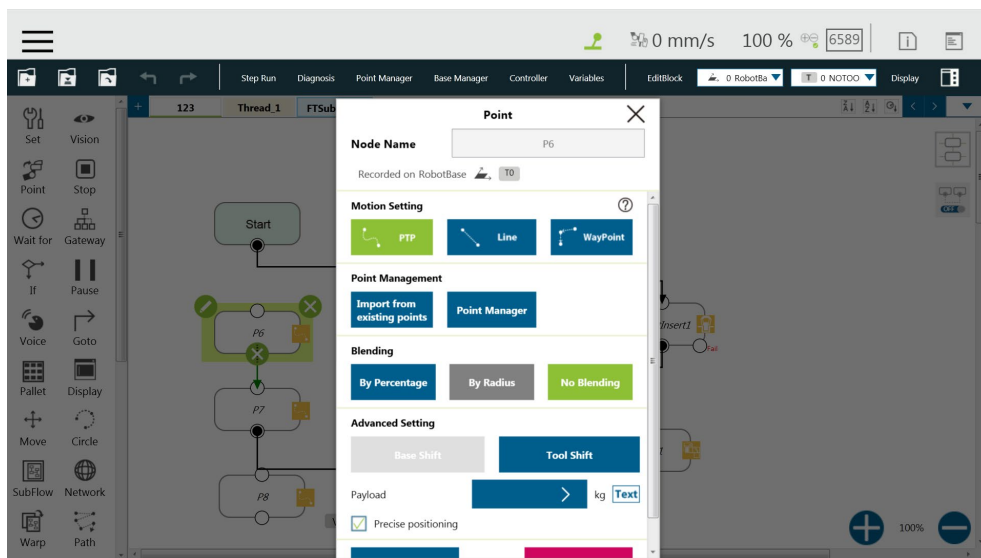
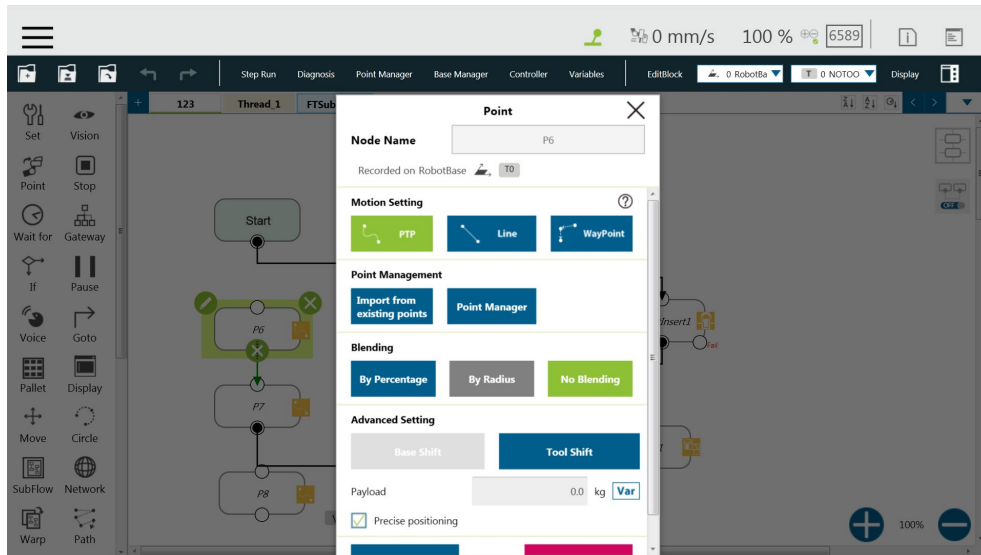

Figure 126: Motion Nodes Support Variable as the Inputs

Also, users can adjust the speed, the payload, the blending settings, and the precise positioning option of motion nodes by selecting nodes to adjust in advance and clicking on the respective buttons in the **Edit Block** menu to adjust in a batch. This feature is applicable to **Vision** (PTP, Line), **Point** (PTP, Line, Waypoint), **Pallet** (PTP, Line, Waypoint), **Move** (PTP, Line, Joint), **Circle** (Line), **F-Point** (PTP, Line, Waypoint), **CVPoint** (Line), **CVCircle** (Line), and **Path** (PTP, Line, Pline, %); however, it is not applicable to **Touch Stop**, **Compliance**, **Smart Insert**.

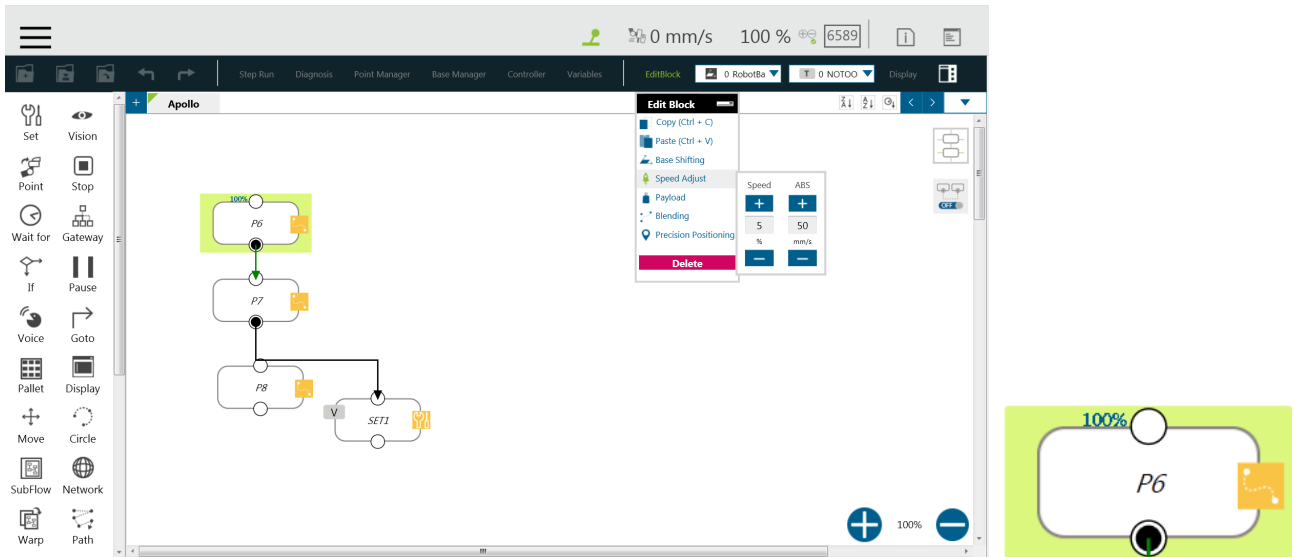





Figure 127: Speed Adjust and Speed Indication on the Node.

9.6.1 Point Node

Users can see the motion type of the point node at the right of the node as shown. Icons for the motion types are  for PTP,  for Line, and  for WayPoint.

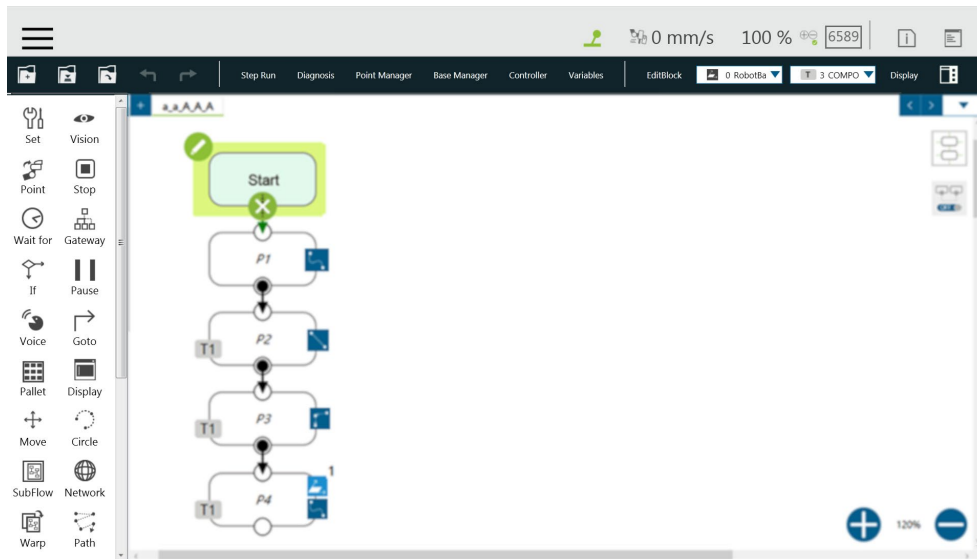

Figure 128: Point Node

9.6.1.1 Generation Method of Point node

TMflow currently has two methods to generate a Point. The point generated will be entered on the list of Point Manager.

1. Drag the **Point** Node from the node menu to the **Project Editing Area** to add the new point.
2. Click **POINT** at the End Module to add the point.

9.6.1.2 Point Node Setting

The Point Node can be set to motion mode, **Blending**, **Base Shift** and **Tool Shift**. The robot will determine the mode of moving to this point according to the above setting.

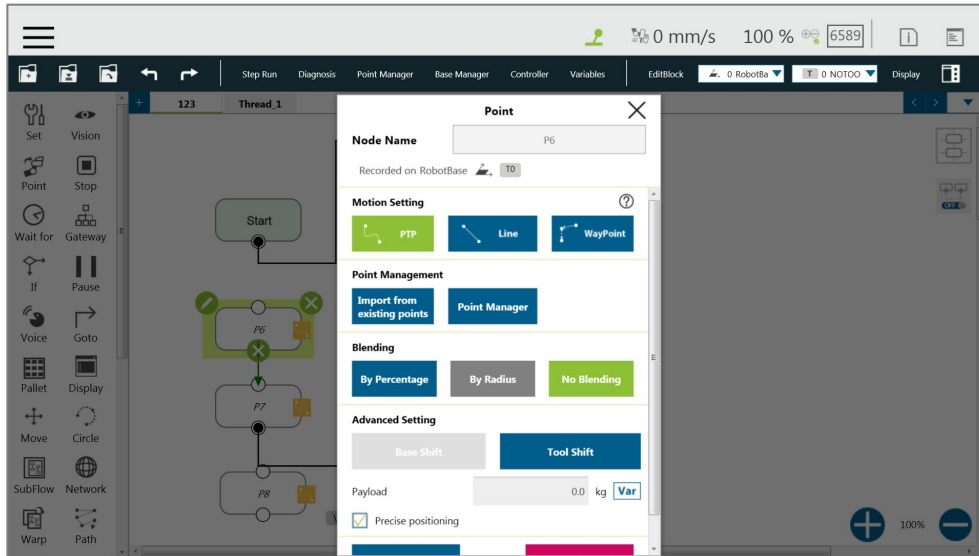

Figure 129: Point Node Setting

- **Motion mode setting:** Set motion type. If selected **PTP**, users can set the **Target Type** to **Cartesian Coordinate** for the robot moving to the target point based on its Cartesian coordinates or **Joint Angle** based on its joint angles.
- **Point Management:** Can choose from a existing point or open the **Point Manager**
- **Blending setting:** Set blending type
- **Advanced setting:** Base shifting / Tool shifting
- **Payload:** Load setting of robot end
- **Precise positioning:** Whether moves to the point precisely

IMPORTANT

IMPORTANT:

If you have not selected **Precise Positioning**, the robot arm will not stop at the **Precision Point** but instead directly move on to running the next command. If you select **Precise Positioning**, the robot arm will wait until motion along all axes has stabilized at the **Precision Point** before moving on to running the next command.

9.6.2 F-Point Node

This Node can perform fine tuning of X, Y, Z Axis $\pm 10\text{mm}$ and Rx, Ry, Rz $\pm 5^\circ$ at the existing point. During the project execution, the F-Point variable can also be corrected in the **View** page. In addition, since inputting variable to fine tuning point is not a safe action when the project is running, the login password protection is designed on the interface. Set and use the settings

appropriately.

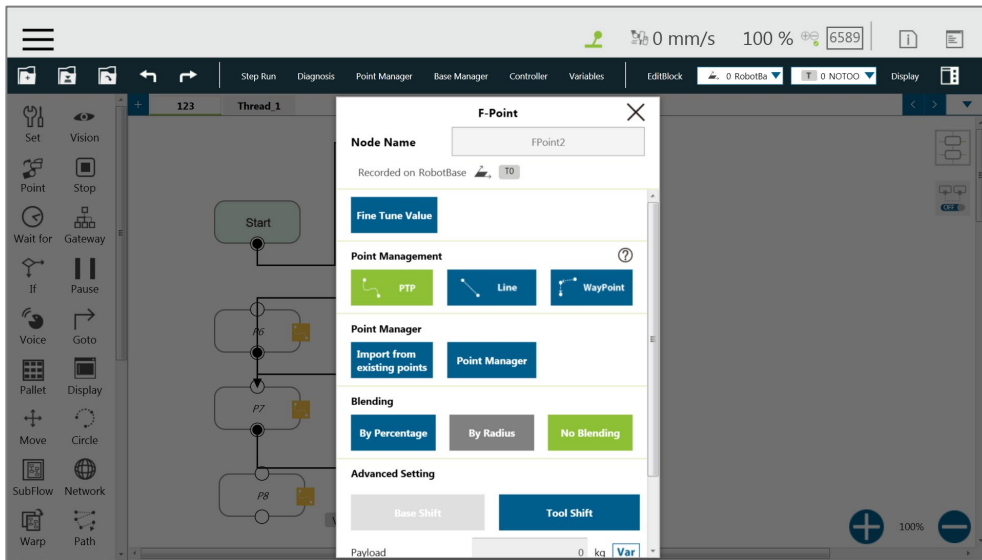

Figure 130: F-Point Node

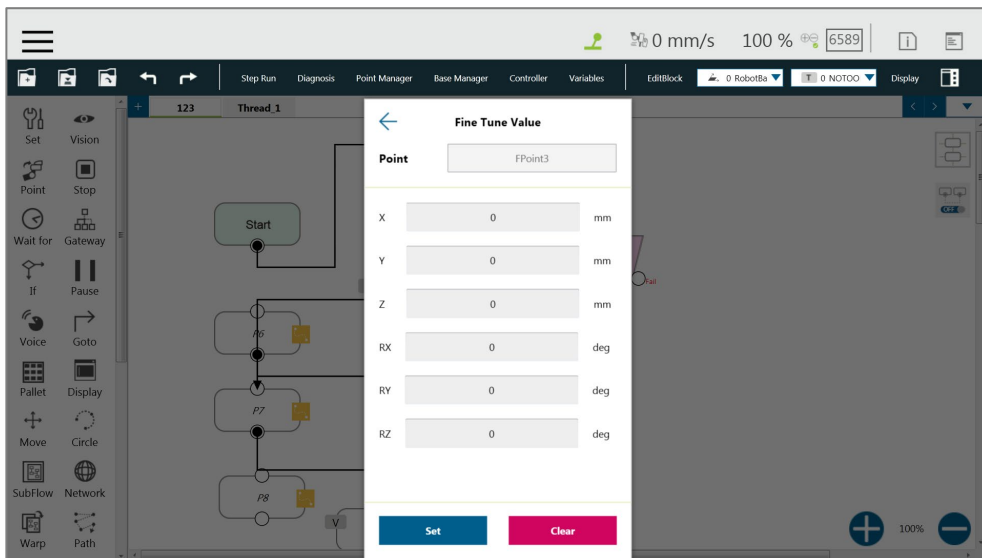

Figure 131: F-Point Node Setting



IMPORTANT:

In a single project, the number of F-Points is limited to 20.

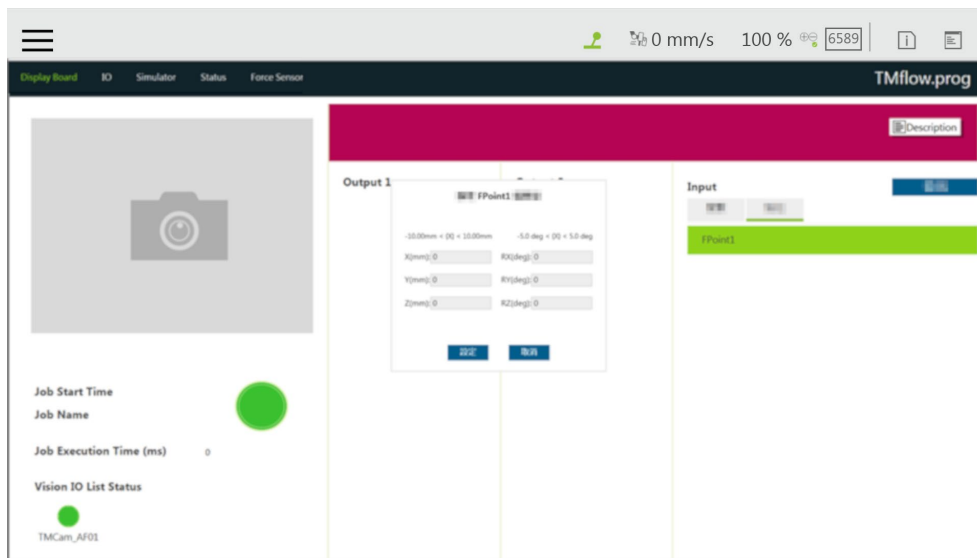

Figure 132: Adjust F-Point Parameter during Project Running

9.6.3 Move Node

In this node, users can set values from the Base X, Y, Z, RX, RY, RZ or six-axis angles J1~J6 to determine robot movement distance/angle, and then perform relative movement from current position.

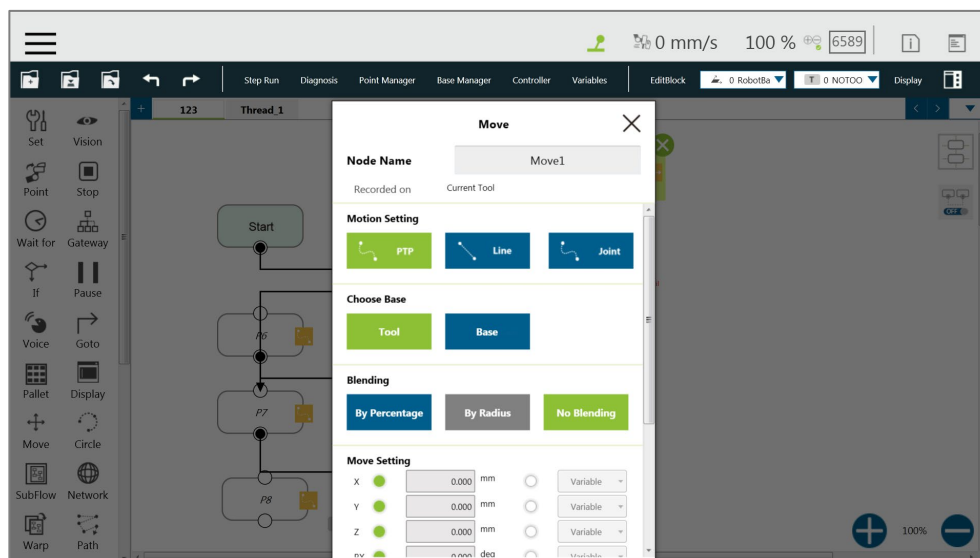

Figure 133: Move Node Setting

- Joint angles can be set to determine the relative movement of the robot
- Relative movement of distance and angle can be set
- The set relative movement distance can be replaced by a variable

To choose a base in this node:

1. Click the pencil icon on this node.
2. Click on **Tool** or **Current Base** below **Choose Base**.
3. When the list prompt is displayed, select an item and click **OK**.

9.6.3.1 Plan for the Move Node

As shown below, users can pick up the stack with a move node. By increasing the z value with each cycle, using the variable, by 5 cm, the four objects can be moved in four cycles.

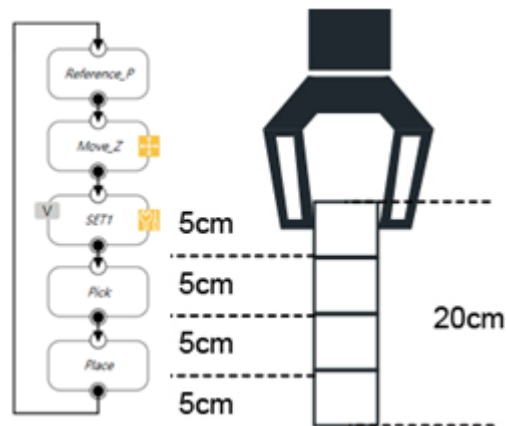

Figure 134: Plan for the Move Node

9.6.4 Circle Node

9.6.4.1 Circle Node Setting

The **Circle** node plans the path pass through point P2 and end point P3, and uses P1 as the path start point, and plans an arc movement.

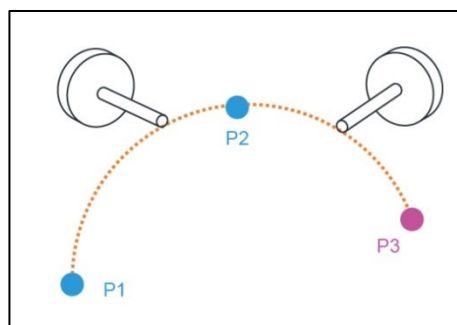

Figure 135: The Circle Node Plans Arc Path with 3-Point Setting Circle

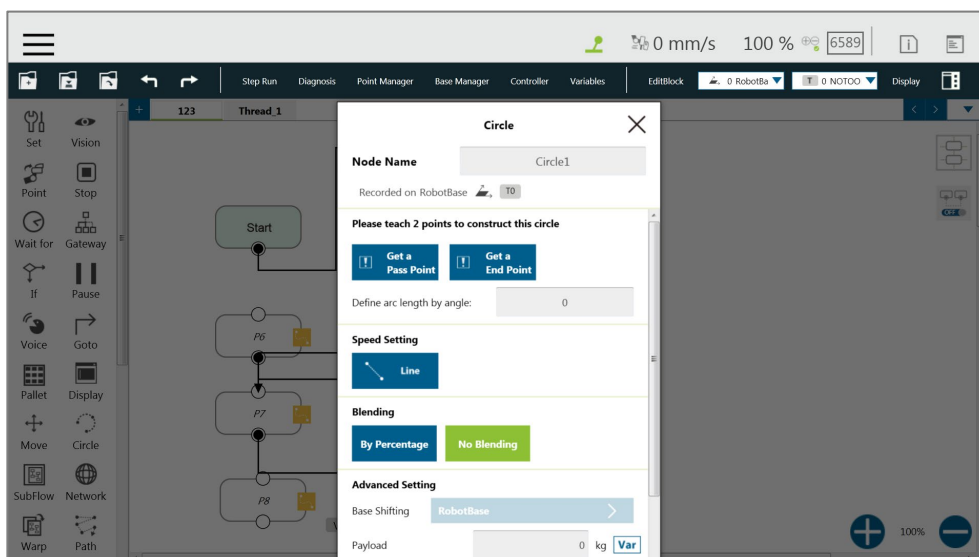

Figure 136: Circle Node Setting

To use the circle node:

- Step 1** Create a starting point before adding the circle node.
- Step 2** In the circle node, set the **pass through point** and the **end point**.
- Step 3** Define path arc length with angle.
- Step 4** Configure the **Speed Setting**.

9.6.4.2 Set Angle = 0°

In 3-point setting circle, users can define the path arch length with angle after setting the **Circle**. When set angle is 0°, the robot will move from P1 **Start Point** to P3 **End Point** through P2. At this time, the robot posture will change with the point, as shown in the figure below.

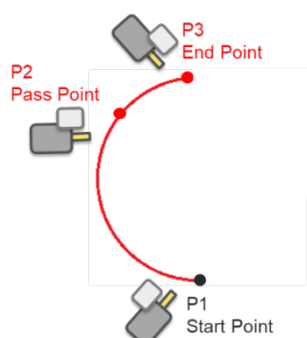

Figure 137: The Circle Motion Status of Set Angle = 0°

9.6.4.3 Set Angle > 0°

Define the path arc with angle, when set angle > 0°, and with 3-point setting circle, the robot

moves the set angle from P1 Start Point through P2, P3. At this time, the robot posture will not change from the P1 point posture.

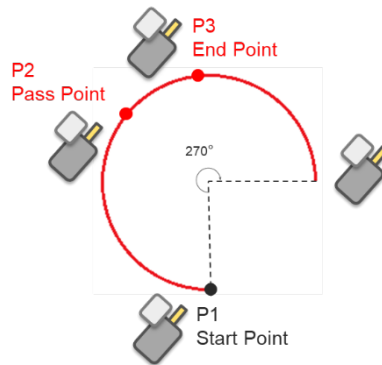

Figure 138: The Circle Motion Status of Set Angle =270°

9.6.5 Path Node

This node can read and run the .Path path file and control the robot to move according to the path in the .Path file.

9.6.5.1 Path and PLine

The Path file is a collection of points that can be generated by a third-party CAD-to-Path software partnered with TM Plug&Play. PLine is a special motion mode of the Path file, and its blending setting is different from that of the Line, providing that the robot can smoothly move between dense points.

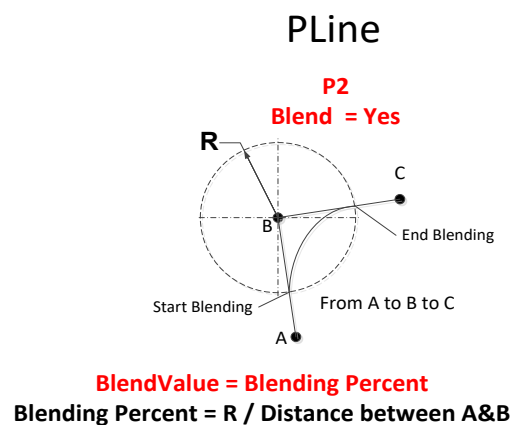

Figure 139: PLine Blending Relationship Chart

9.6.5.2 Path Node Setting

- **Path File:** Select Path to run from the Imported Path File
- **Speed:** Set the speed percentage when the path is running. Applicable to the 1st point at the same time. Users can also check the box before **Link to project speed** to align the

node speed with the project speed.

- **Data Type:** Select **Time** for motions with inconsistent speed or stops and **Position** for consistent speed motions.
- **Direction:** Set to go **Forward** or **Backward** along the path.
- **First Point Motion Setting:** In the initial point setting, the PLine mode can be selected only when the 1st point of the path is PLine, and the speed setting is ABS. If selected **PTP**, users can set the **Target Type** to **Cartesian Coordinate** for the robot moving to the target point based on its Cartesian coordinates or to **Joint Angle** based on its joint angles.
- **Path Management**
 - **Path Property:** Path Property displays the **Tool** and **Base** of the **Path**. Users can also save new Path files and change the Base in this Menu.
 - **Path Task:** IO Setting of **Point on Path**

Note

NOTE:

When selecting the point in **Path Task**, the target point is the display parameter value plus 1. For example, the display parameter 0 denotes the first point of the path.

- **Advanced setting:** Base shifting / Tool shifting
 - **Change payload to:** If equipped, set the weight of the device at the end of the robot in kilogram.
 - **Precise positioning:** Whether moves to the point precisely

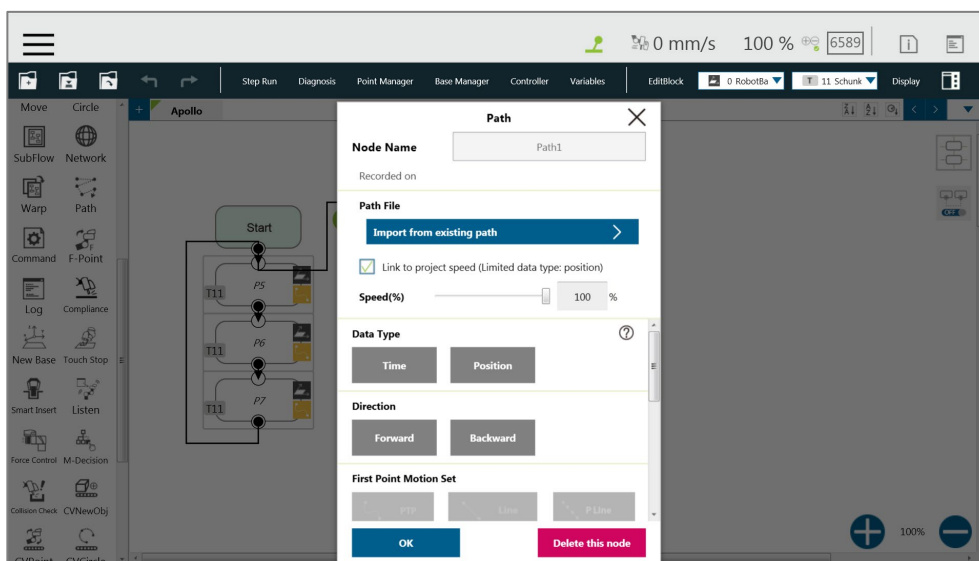

Figure 140: Path Node Setting

9.6.5.3 Path File Import and Export

Refer to 5.8.6 Import/Export for Path File Import/Export. When importing the **Path** file, import **Base** and **Tool** together, setting the same name of (i.e. Path1_Base, Path1_Tool) in the **Base** and **Tool** list of the flow. Path file import is only applicable to user-specified projects and preset with **Robot Base** and **NoTool** if there is no **Base** and **Tool** information. Users can also use the path file generated from **Path Generate**. Refer to 5.6.3.10 Path Generate for details.

9.6.6 Pallet Node

This node can set three-point coordinates and the values of row and column to control the robot's motion between the rows and the columns. There are a total of two modes, applicable to regular display applications, such as: pallet placement applications.

- **Pallet Pattern:** Set the pallet pattern that goes from the left or the right line by line with or without carriage returns.
- 3 points establish Pallet: The 1st **Point** is the start point of the 1st row and determines the robot posture. The 2nd **Point** is the end point of the 1st row, and the 3rd **Point** is the end point of the last row.
- **Number of Rows and Columns:** Define the number rows and columns.

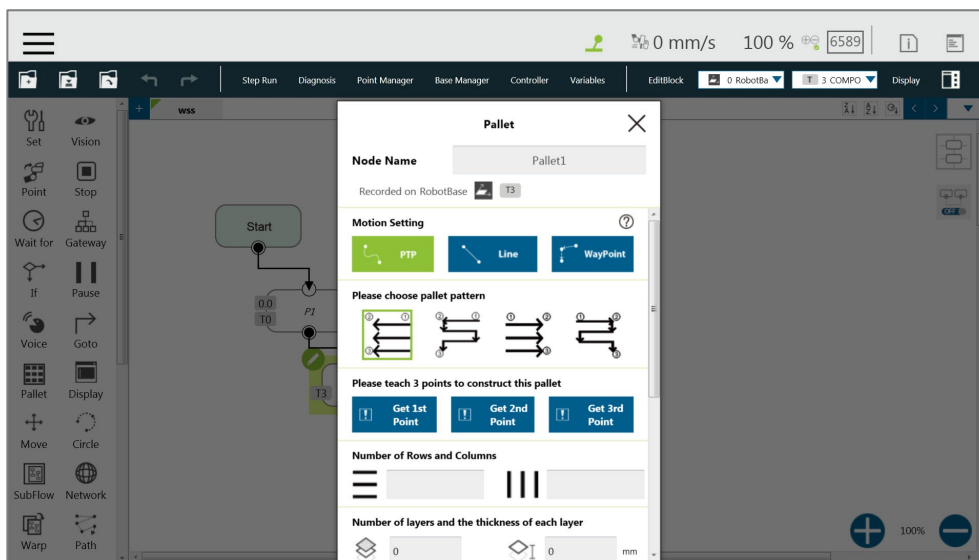

Figure 141: Pallet Node (1/2)

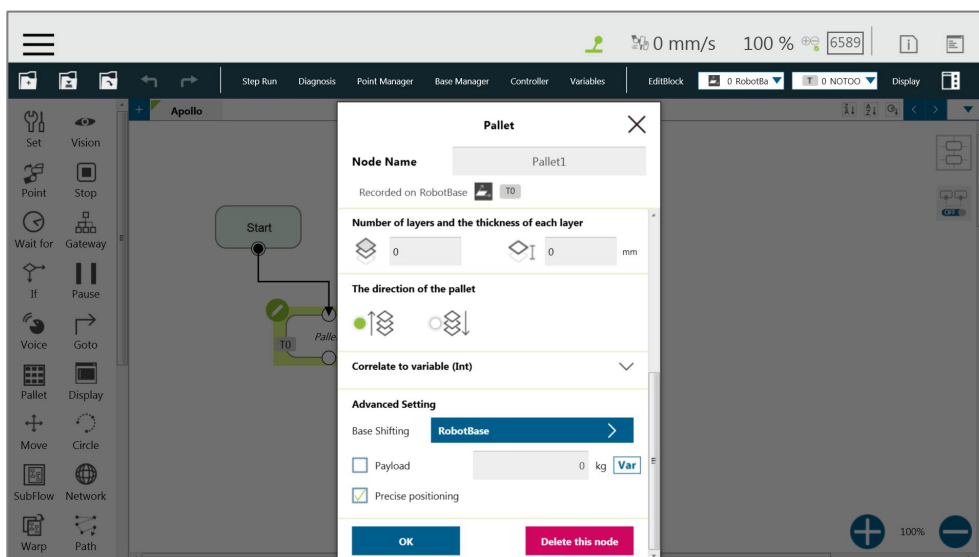

Figure 142: Pallet Node (2/2)

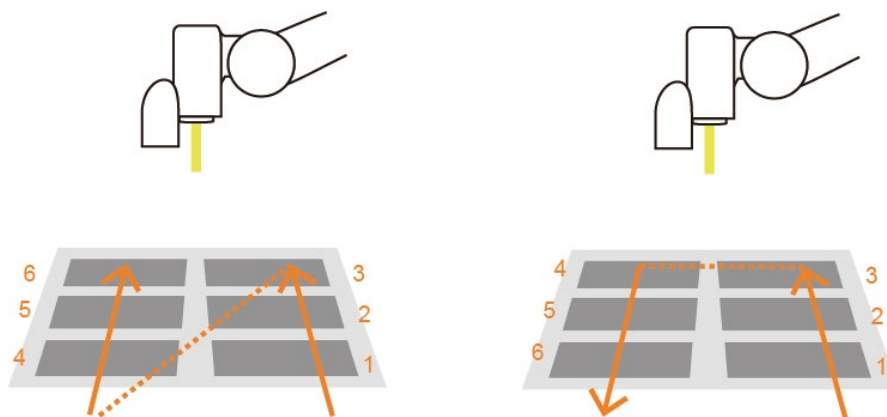
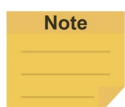

Figure 143: Pallet Patterns

- **Number of layers and the thickness of each layer:** Set number of levels and height of each level
- **The direction of the pallet:** bottom-up or top-down
- Pallet will automatically generate a set of variables of row, column, and layer numbers, connected to Pallet movement position



NOTE:

1. Users can use the function of **Correlate to variable** to correlate the row and column with variables. After variables are assigned to the row and column, the variables can be used to manipulate or display which slot in the Pallet is to be implemented. The amounts of the target column, row, and level are their correlated variables plus 1. For example, the target row is the third row, and the value of its correlated variable is 2.
2. Teaching points without following the sequence of the chosen pattern may result in the opposite of Z-axis.



IMPORTANT:

Pallet needs to work with a Loop in order to move to the next position of the **Pallet**.

9.6.7 Listen Node

In the Listen Node, a socket server can be established and be connected by an external device to communicate according to the defined protocol. All the functions available in **Expression Editor** can also be executed in **Listen** Node.

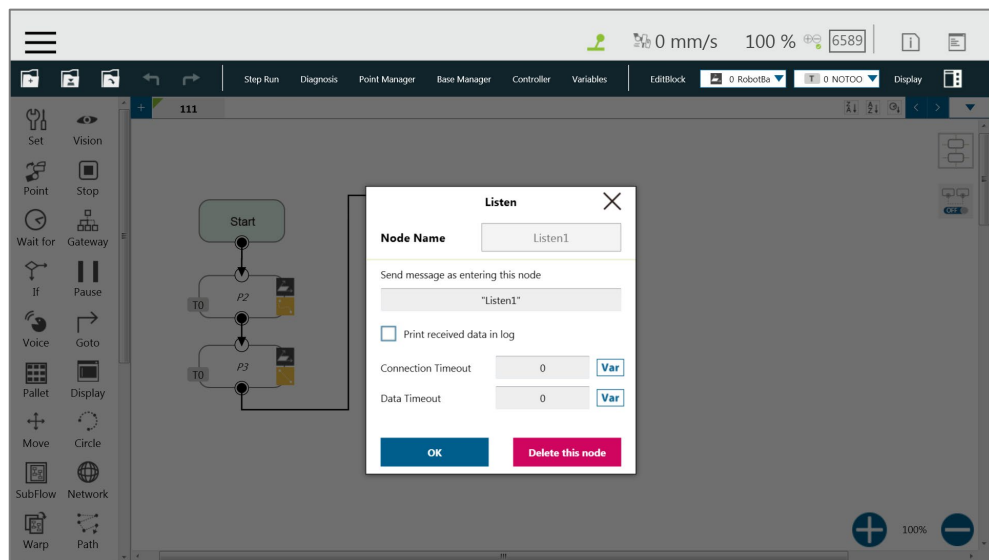

Figure 144: Listen Node

Send Message: When entering this node, it will initiate a message

Print Log: Enable Communication Log (shown on the right)

Connection Timeout: When entering this node, if more than the Connection Timeout (milliseconds) passes without connecting, it will timeout. If ≤ 0 , no timeout

Data Timeout: When connected, the timeout will be exceeded if no communication packet arrives in Data Timeout milliseconds. If ≤ 0 , no timeout

Socket Server is set up after the project is running and closed after the project is stopped. When the Socket Server is successfully established, the IP and Port will be displayed in the Notice Log window on the right.

IP HMI → System → Network → IP Address
Port 5890

When the process enters the **Listen** Node, it stays in the **Listen** Node until it triggers and leaves with the exit condition.

Pass: Executes ScriptExit() or item stopped

Fail: 1. Connection Timeout
 2. Data Timeout
 3. Before the Socket Server been established successfully, the flow process has entered the Listen Node

The commands received by the listen node will be executed in order. If the command is not valid, an error message will be returned carrying the line number with errors. If the command is valid, it will be executed.

The commands can be divided into two categories. The first category is commands which can be accomplished in instance, like assigning variable value. The second category is commands that need to be executed in sequence, like motion commands and IO value assignment. The second category command will be placed in the queue and executed in order. Refer to the manual *Expression Editor and Listen Node* for details on commands and communication format.

10. Logic Programming

10.1 Overview

This Chapter will introduce the logic nodes commonly used in **TMflow** programming, explain its basic features and use methods, and let users understand how to let robots understand instructions and commands and determine the next motion. In the area of logic programming, the most important aspect is the application of variables. In **TMflow**, variables are mainly divided into two categories: **Global Variables** and **Local Variables**, therefore, this chapter will introduce variables first and explain how to assign them. It then covers basic explanations and examples of how the logic nodes are paired with these variables.

10.2 Variable System

10.2.1 Local Variables

Local Variables can only be called in a single project, and their effective range is only within the project that created these variables. Variables are created through the Variable tab, at the top of the **TMflow** interface. In this page, a single variable or array variable can be declared and assigned a value. According to the different data formats, **TMflow** provides six types of variables: **int**, **float**, **string**, **double**, **bool**, and **byte**. The meaning of the variables is shown in the table below. If no value is assigned, a string initial value of empty, and the remaining variables default to 0. The newly added local variables will appear in the project's variable system, and begin with "var_" to represent local variables in the variable system. Users can use dropdown to filter available variables in the list, and sort variables in the list with the buttons of reverse alphabetical, alphabetical, or chronological. Click the **Batch Delete** button to select multiple variables to delete.

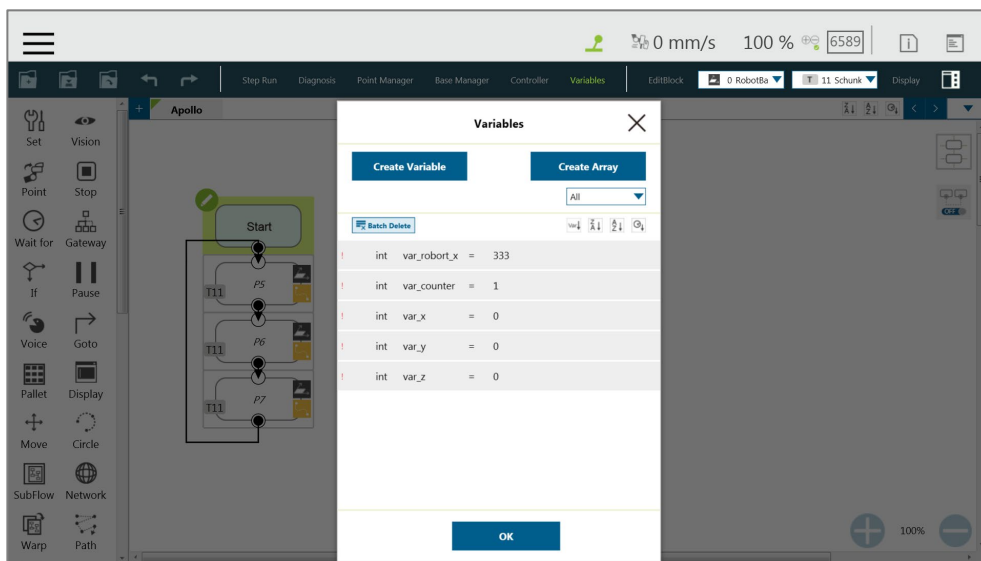

Figure 145: Variable System

Type	Type Description	Saved Data
string	String	Structure composed of characters, such as "TMflow" (double quotes must be added to enclose the string)
int	Integer	$-2^{31} \sim 2^{31} - 1$
float	Floating point number (decimal)	$10^{-37} \sim 10^{38}$ (Effective digit 6~7 digits)
double	Double-precision floating-point number	$10^{-307} \sim 10^{308}$ (Effective digit 15~16 digits)
bool	Boolean	True, False
byte	Byte	$-2^7 \sim 2^7 - 1$

Table 8: Variable Data Types

After clicking the newly added variable, the declaration of a variable can be performed. For example, the integer type variable `TM_Robot=0` can be declared.

In addition to declaring a single variable, variable arrays can also be declared. The array declaration method is to set the name of the array variable and the size of the array. The default size is 0. As an array with size 10 and name Array is declared, the Array {0, 0, 0, 0, 0, 0, 0, 0, 0, 0} can be obtained. If users want to obtain the first value of the array, `Array[0]` can be called in calling the array **SET** Node.

To edit a variable or an array, select the item and click the pencil icon. For variables or arrays, the data type is not editable, and for arrays, the array size is not editable, either. Users can edit variables or arrays with naming starting with `var_` only.



IMPORTANT:

The number of first element of the array is 0.

10.2.1.1 Global Variables

The **Global Variables** can be accessed by clicking **Global Variable** in **Robot Setting**.

Global Variable values can be accessed or changed in different projects.

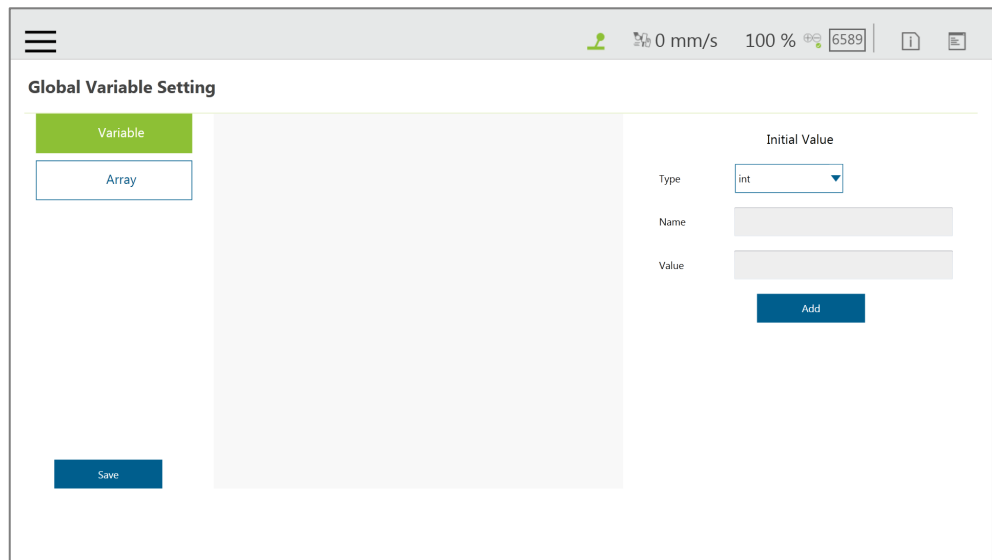

Figure 146: Global Variable Setting

As shown in the figure below, an integer type **Global Variable** is declared as a. The newly added **Global Variable** will appear in the project's variable list, and it will be represented as a **Global Variable** starting with "g_".

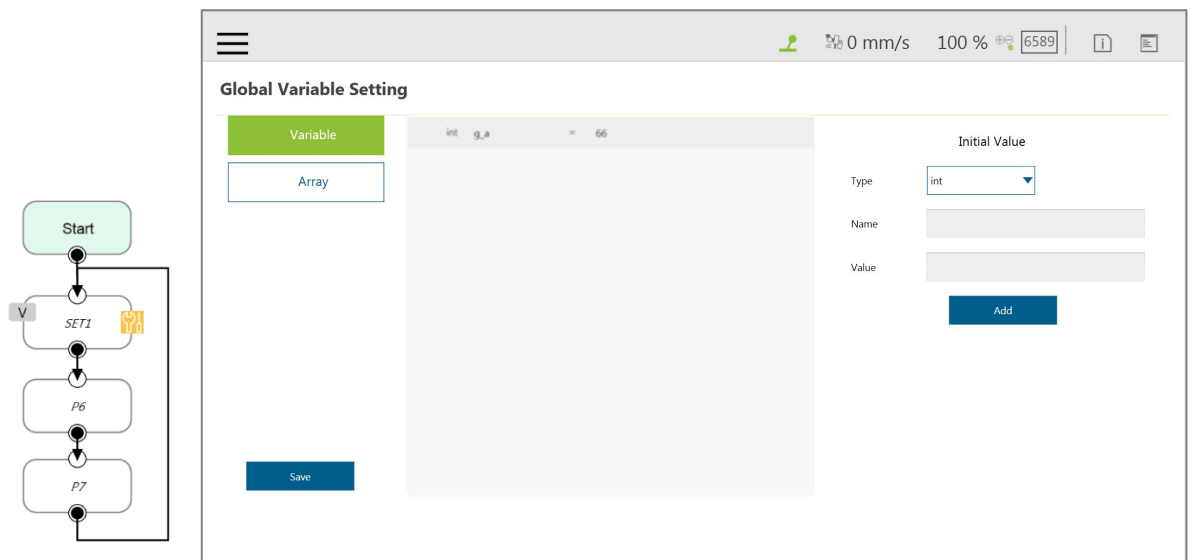

Figure 147: Global Variables after Project Is Run

If, for example, users create a global variable with a name of 'a', this will be displayed by TMflow as "g_a", indicating that it is a global variable. The global variable "g_a" defaults to a value of zero. If the SET node increments the value of "g_a" by one each time it is executed, after running the project 66 times the value of "g_a" will be 66. At this point, any other project

that accesses “g_a” will get the value 66 for the variable.

IMPORTANT

IMPORTANT:

Global variables will not be re-initialized when the system shuts down. They will retain their value.

10.3 Logic Nodes

Note

Note:

Due to the limited I/O status refresh rate of the system, Safety I/O status reading is designed for monitoring mainly. Conditional statements in logical nodes such as If Node and Gate Node involving in Safety I/O statuses are not recommended, otherwise the project may not execute as users expected.

10.3.1 Start Node

In this node, users can view and set the initial state of the current project such as the initial project running speed in Manual mode (the initial project running speed in Manual Mode is fixed at 5% by default). Also, users can reset the states of DO and AO at the beginning of the project to initialize DO and AO before the project starts. Check **Enable continuous motion** to prevent the IO writing from interrupting the robot moving along the path of points for a smooth process of moving.

Enable continuous motion is unchecked by default.

10.3.2 SET Node

This node can set the states of IO, and change the type and value of variables. When passing through this node, all parameters in the node will be changed to the set result.

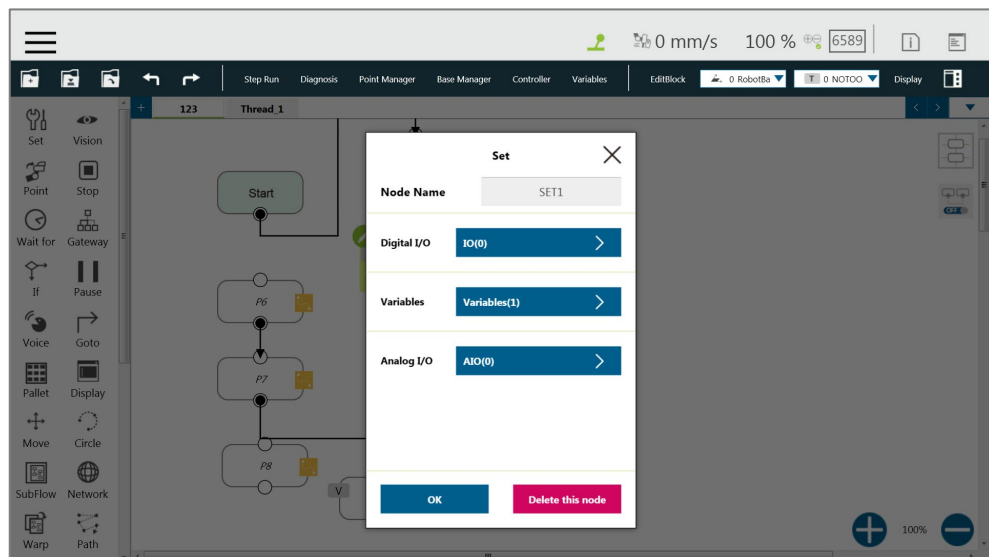

Figure 148: SET Node

In the application of variables, the **SET** Node can add and subtract variables, associate with the **IF** Node to select the path, or interrupt the infinite path of the project. As shown below, set an integer type of variable count=0. Each time it passes through the **SET** Node, the count value is incremented by 1. Users can use Display to show the number of times the project has been run.

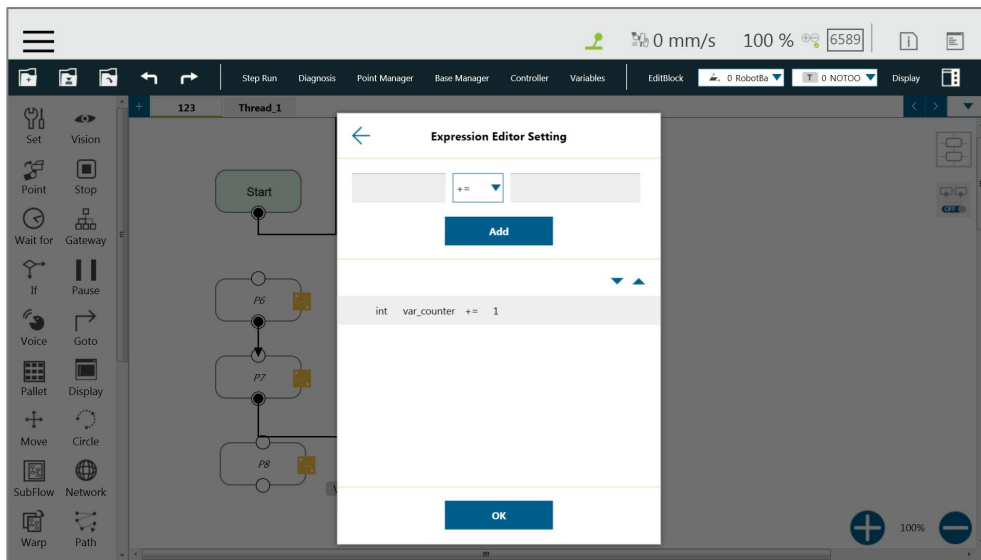

Figure 149: Variable Count

Syntax	Meaning
$a += b$	$a = a + b$
$a -= b$	$a = a - b$
$a *= b$	$a = a * b$
$a /= b$	$a = a / b$
$a = b$	Specifies the value of a is b

Table 9: SET Syntax List

Note

NOTE:

Point, Base, TCP, VPoint, IO, Robot, and FTSSensor in the flows are now parameterized, and users can write variables as parameters to the objects and read from the parameters for calculations or applications with their types, Name/IDs, and attributes. For more details, Refer to the manual of *Expression Editor and Listen Node*.

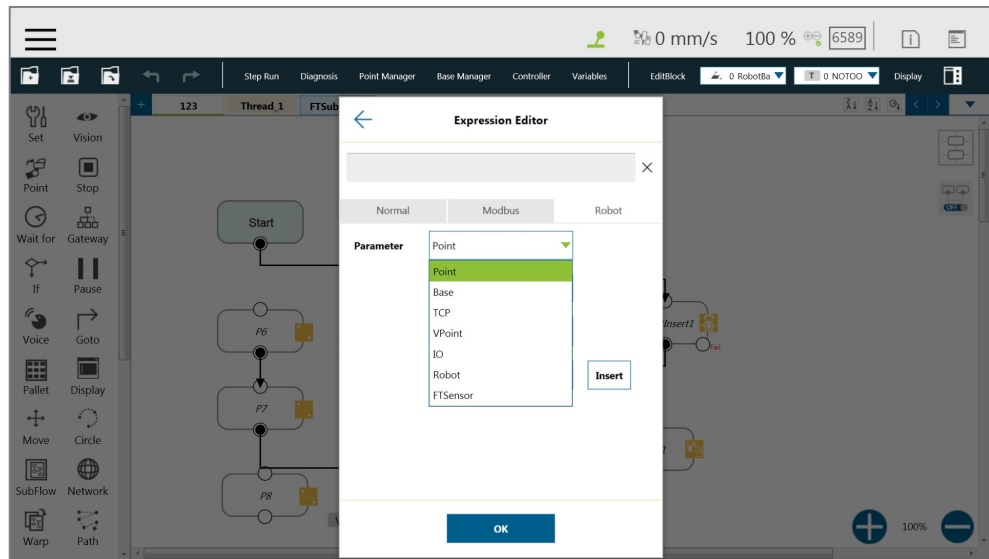

Figure 150: Expression Editor Parameters (1/2)

Note

NOTE:

1. Using parameterized objects is the same as using user defined variables. Parameterized objects can be used without declarations to get or modify point data through the syntax in the project operations and make the robot move with more flexibility. The expression comes with three parts: item, index, and attribute.
2. A base index is added to the base parameters to act as the choice of the bases, eg. Base["(base name) " ,(base index)].value[]. The default value is 0 if there is no number assigned to base index.
3. Writing to the bases parameters is added with the same syntax as shown above. Only the value is writable, and other properties are read only.

If there are multiple equations in **Expression Editor**, users can click on the equation to move, and use the triangles to move the equation up and down for the process sequence.

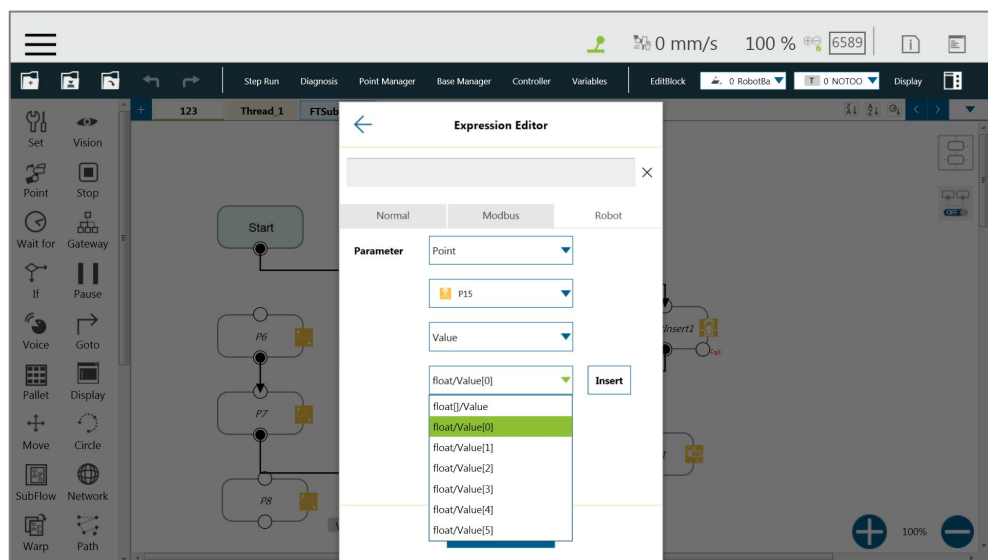

Figure 151: Expression Editor Parameters (2/2)

In the box below, the existing variables can be selected and used for calculation.

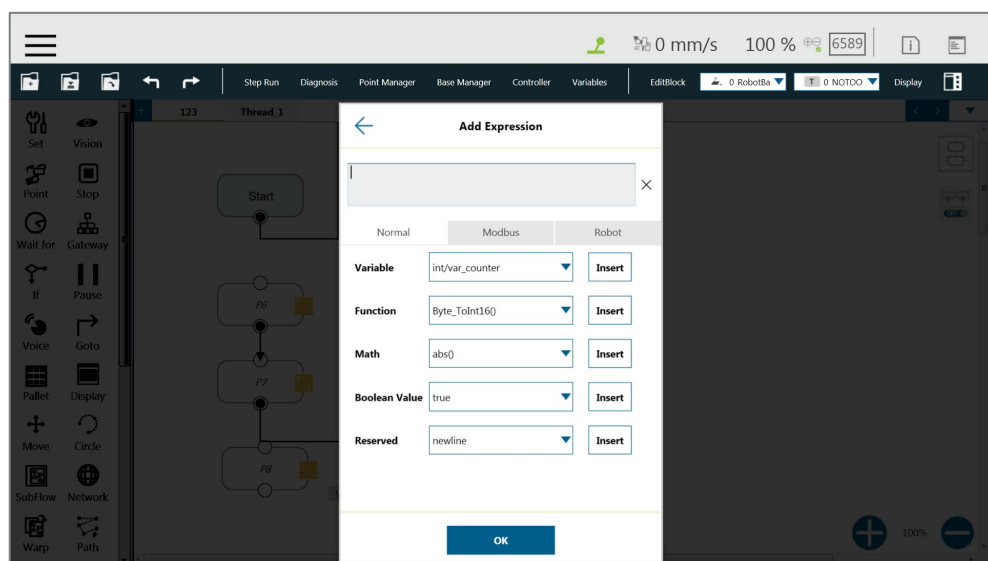

Figure 152: Add Expression

The **SET** Node can also set the **Analog IO** such as enabling **Analog IO** while passing through the **SET** Node and giving the external device a specific voltage until a different node stops the output voltage.

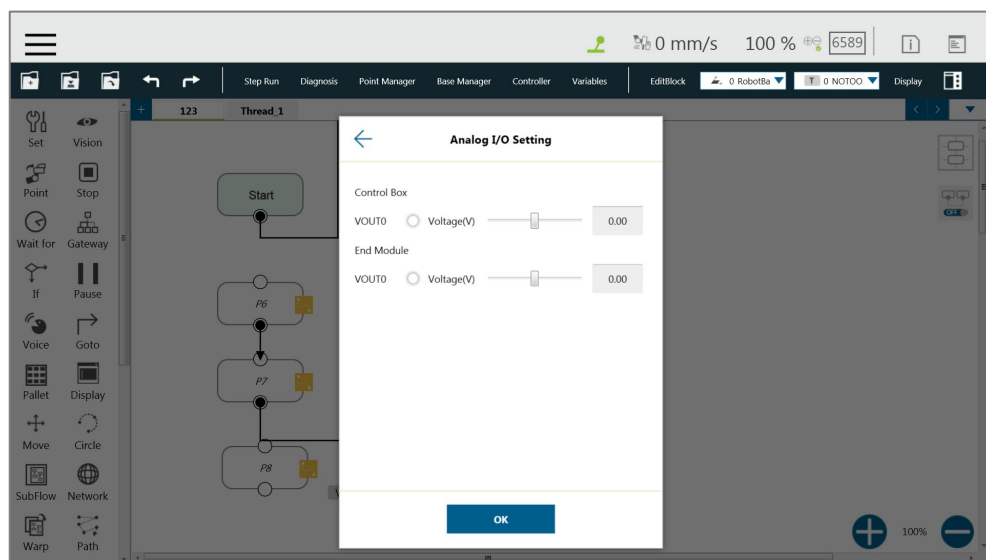

Figure 153: Analog I/O Setting

10.3.3 IF Node

In real robot operations, different conditions may result from many factors. For example, job failure, success, and communication errors may occur in various function nodes. These results will return the corresponding variable values. Users can use the **IF** node to handle these conditions according to different variables. The **IF** node can judge or compare the state of IO, the state of a **Variable**, and judge the state of **Compliance** as well as take the **Yes** or **No** path according to whether the condition of the judgment is reached.

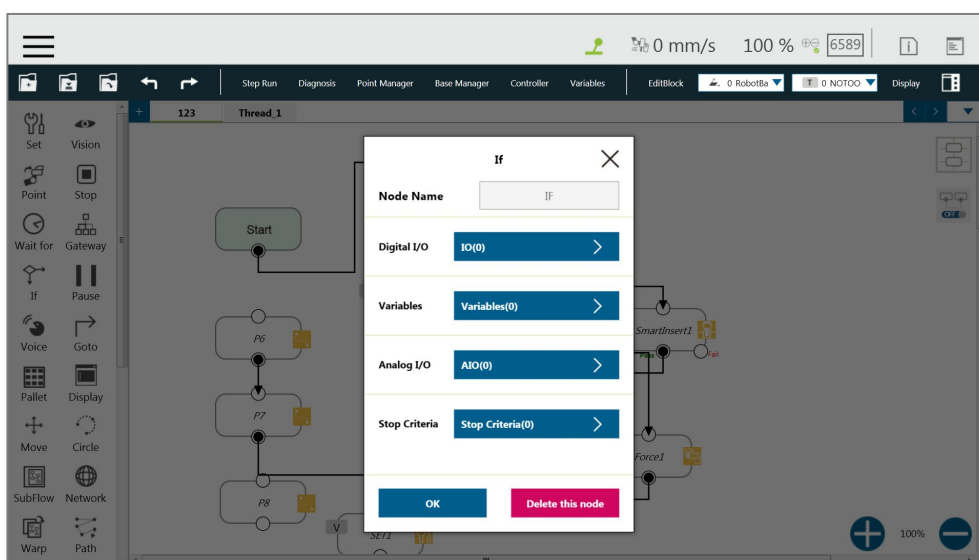

Figure 154: IF Node

Operator	Description
<	Less than
>	More than
==	Equal to
<=	Less than or Equal to
>=	More than or Equal to
!=	Not Equal to

Table 10: If Judgment Operators

In the judgment of stop criteria, as shown in the figure below, the variables obtained from the result in this project are used to program the following flow.

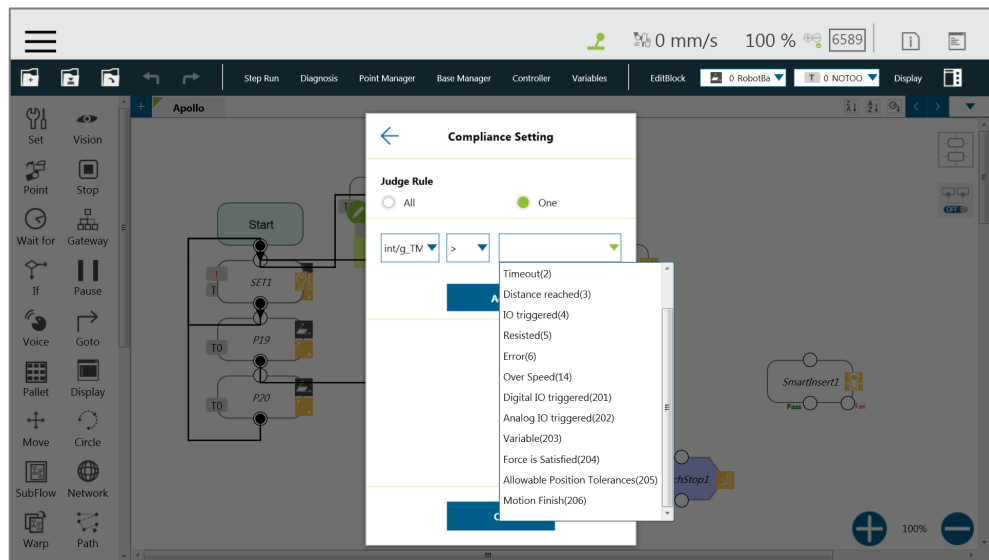

Figure 155: IF Node Stop Criteria Setting

10.3.4 WaitFor Node

The main function of the **WaitFor** Node is to hold the project, and continue to run after the set conditions are met. It can be set according to **IO**, **Time**, **Variables** and other conditions to judge whether to resume the run.

10.3.5 Gateway Node

The **Gateway** node is a conditional judgment formula which is similar to **IF** Node. Instead of output as **YES** or **NO** (**IF** Node), the **Gateway** node has a corresponding number of sub-nodes called **CASE**. When the project flow reaches a **Gateway** node, **CASE** condition(s) would be judged from left to right, if any condition is met, the project flow would continue from the output of

that **CASE** sub-node, and the judgment of the rest of the **CASEs** are skipped.

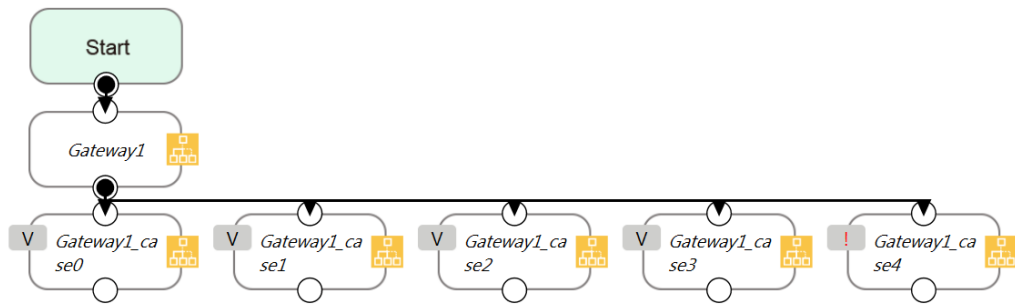

Figure 156: Gateway Node Judges Five Conditions

As shown above, there are 4 conditioned **CASEs** (and 1 **Default case**) which is relevant to using 4 **IF** Nodes as shown in the figure below. From the view point of simplicity, **Gateway** nodes can simplify the layout and increase visibility of the flow.

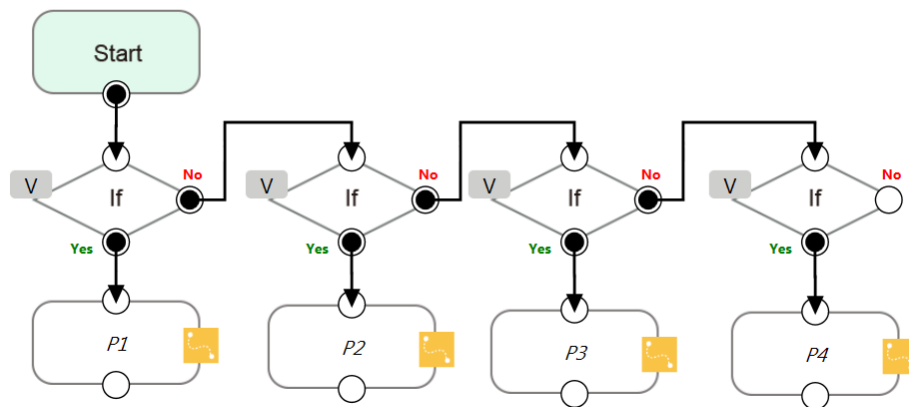

Figure 157: IF Node Judges Four Conditions



NOTE:

If no conditions are matched, the project flow would remain deadlocked at the **Gateway** node. Therefore, it is necessary to have a default case so that the project flow can continue which is practical by leaving the last case sub-node with no condition

10.3.6 M-Decision Node

The **M-Decision** node comes with respective numbers of sub-nodes called **CASE** similar to **Gateway** Node. When the project flow reaches a **M-Decision** node, the flow pauses and prompts users to decide the **CASE** condition. Once decided, the project flow would continue from the output of that **CASE** sub-node.

Note

NOTE:

- When the flow reaches the M-Decision node:
 1. Users cannot change the project speed.
 2. The message box to prompt users making decisions in the view page, and only those who get control of the system can make decisions.
- M-Decision node is applicable to the main project flow, subflow, and thread.

10.4 Process

10.4.1 Process Nodes

Flow nodes are mainly divided into four major categories: **Pause**, **Stop**, **Goto**, and **Warp**. The function of the **Pause** node is the same as the pause on the **Robot Stick**. If the project is running, and passes the **Pause** node, the project is paused. The **Robot Stick** can be used to override the Pause, so the project continues to run. Users can use voice function in a **Pause** node. The robot will read out the content when reaches the node.

The function of the **Stop** Node is the same as the **Stop Button** on the **Robot Stick**, as shown in the figure below. If the project is running, and passes the **Stop** Node, the project is ended. No node can be connected after **Stop**. If a **Stop** node does not exist in the flow, the project will not end automatically. It is necessary to press the **Stop Button** on the **Robot Stick** to end the project.

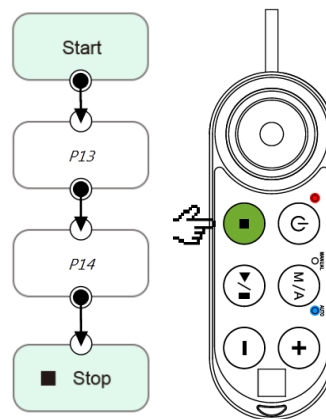

Figure 158: Stop Node Ends Project

The **Goto** Node provides users with unconditional transfer in the **TMflow**. When passing through this Node, it will directly transfer to the set target Node, as shown in the figure, to use the **Goto** Node. If the condition of the judgment formula is met, the next step transfers to P1 directly. Although the application of **Goto** can be achieved using the connection method, the complexity of the line will reduce the readability of the flow. The **Goto** Node will display the connection path only when the node is clicked, and the path of the connection will be displayed and indicated by red lines.

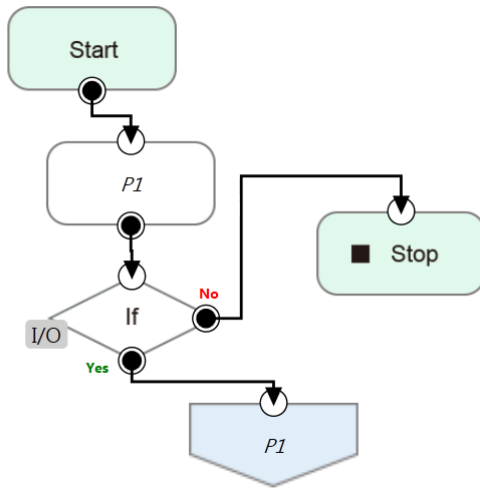

Figure 159: Goto Node Flow Transfer

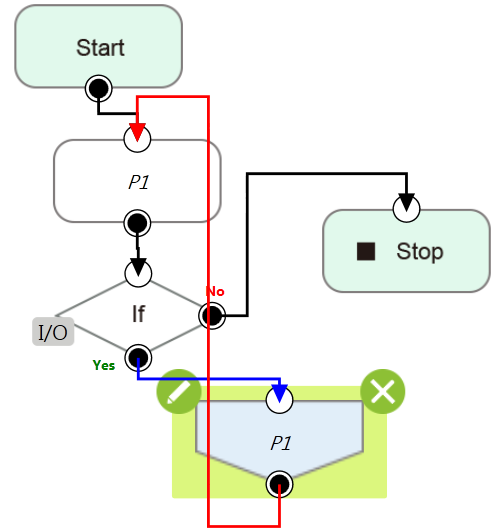

Figure 160: Goto Node Connection

The **Warp** Node transfers control the flow to another project and proceeds to run the target project. Nodes in the original project that occur after the Warp are not executed. The parameters of **Variables**, **Base**, and **Tools** will not pass to another project. If users want to transfer **Variables** between two projects, **Global Variables** can be used. As shown in the figure, when the **TMflow** of project runs beyond the **Warp** Node, the execution is transferred to another project.

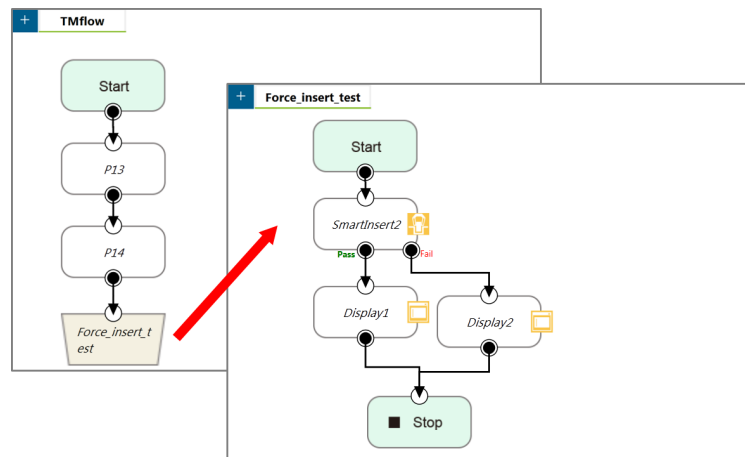

Figure 161: Warp Node Transfers to another Project

Since the **Warp** node applies to transfer the flow between projects, the time consumed to warp between projects varies from the mechanism for the initiations and the terminations of the projects. To run the **Warp** node at its best efficiency, mind each of the following as listed:

1. No warning while the project is running.

2. Do not insert the dongle key.
3. Operate in Auto Mode.
4. The warp target speeds up after running for the second time.



NOTE:

Users can use variables of type string to store project names to warp.

10.4.2 Subflow Node

When the number of Nodes in the flow becomes large, certain blocks of the project may be used repeatedly. If the Nodes in these repeated blocks need to be modified, it may cause inconsistencies in the parameters; therefore, the **Subflow** Node of **TMflow** can be used. This Node will create a new page, and share the **Variables**, **Tool** parameters, **Bases** with the original page. The concept of modularization created with this method allows users to simplify the project editing flow, and improves the readability of the flow. During flow programming, it is recommended to use **Subflow** to simplify the whole flow, as shown in the figure, in this project the nodes running the same action only need to be programmed once.

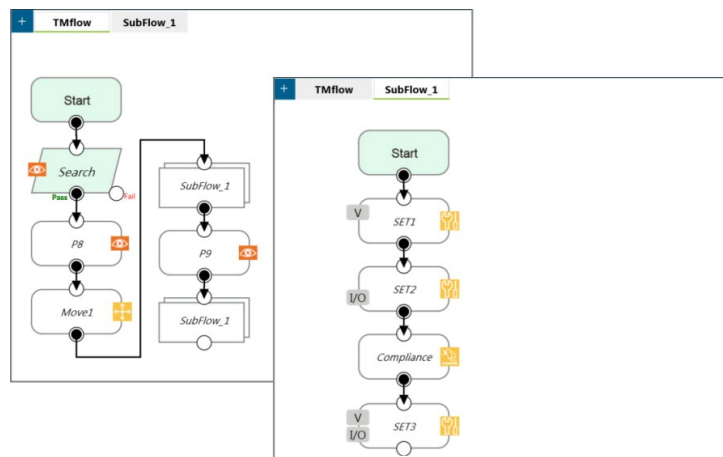



Figure 162: Subflow Node Modularization Concept

The **Subflow** Node can be dragged into the flow from the node menu. If the current project does not have any **Subflow** pages, a new page will be added automatically. If the current project already has **Subflow** pages, a query box will pop up, asking whether to create a new page. In addition, users can click  at the top left of the project editing page to add a new **Subflow** page, and connect the **Subflow** in the field of **Select Subflow** of the **Subflow** Node. If this page needs to be deleted, click the **Edit** icon of the **Start** Node in the **Subflow** page to delete.

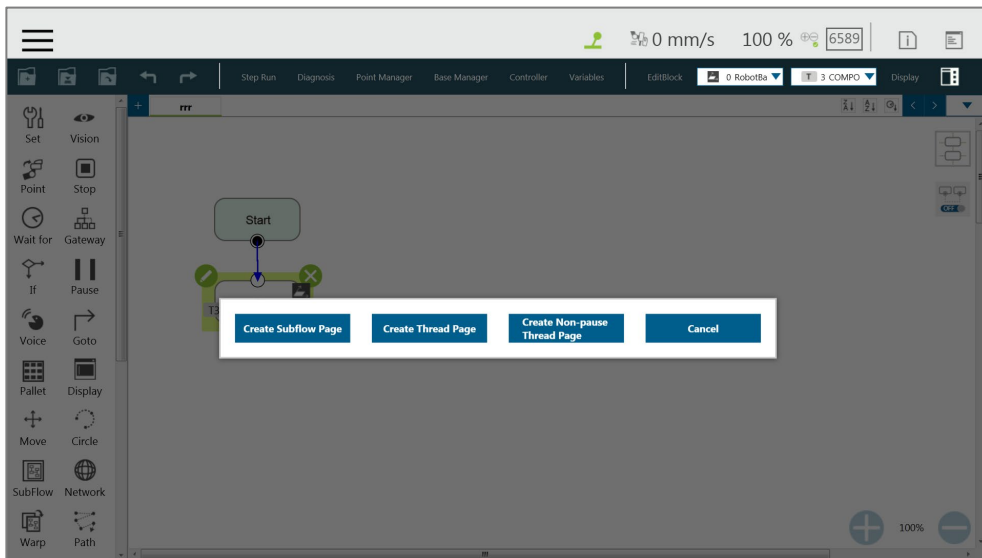

Figure 163: Menu to Create Subpages

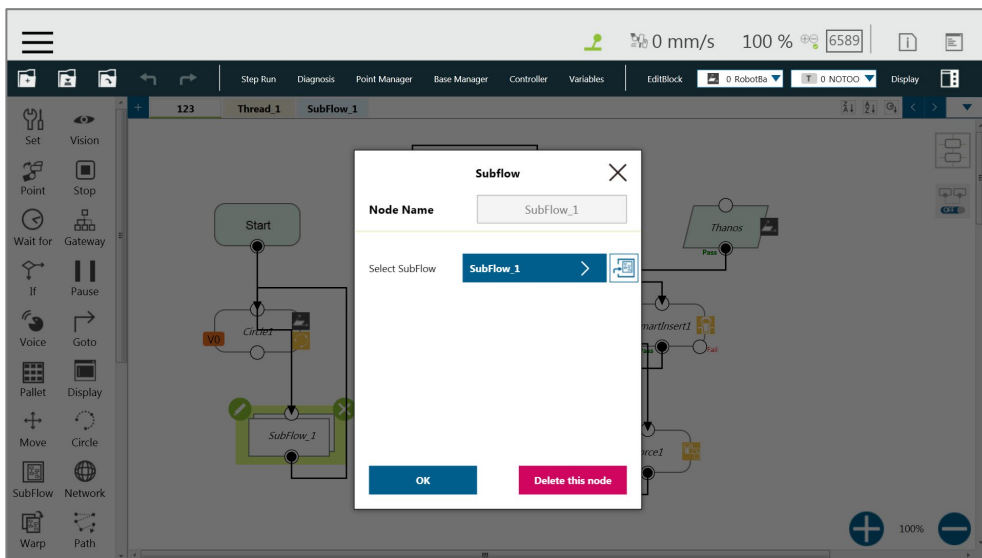



Figure 164: Select a subflow in the subflow node (1/2)

Users can click  next the field of **Select Subflow** to switch the tab of the flow editing page to the selected subflow in the background.

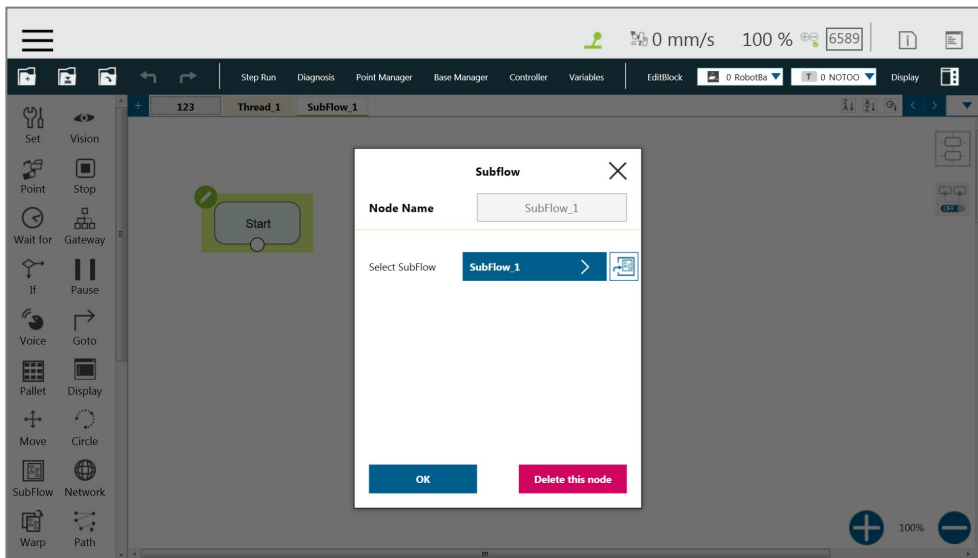

Figure 165: Select a subflow in the subflow node (2/2)

10.4.3 Thread

TMflow provides the function of **Thread**, allowing state monitoring and data acquisition to be independent from the robot. Click the query box popped up on the top left of the flow tab to add a **Thread** page.

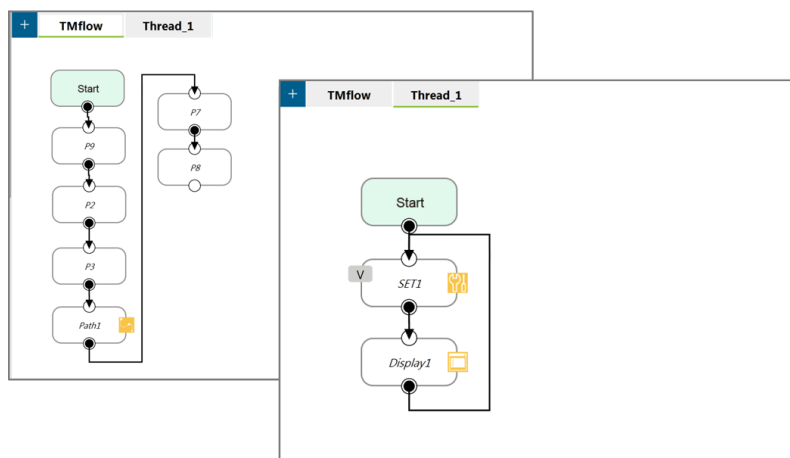

Figure 166: Thread

Inside the **Thread** page, only these actions can be added to the **Project Editing Page**: the logic to judge, and the value of the node to display. No motion node is available in the **Thread** page. There are two types of thread pages, the **Thread Page**, and the **Non-pause Thread Page**. When the project is paused, the **Thread Page** is also paused at the same time, and the **Non-pause Thread Page** does not pause so that users can still read data or update variables in the **Non-pause Thread Page**. To delete the page, click the **Edit** icon of the **Start** node in the subpage to delete.

11. Vision Node

The **Vision** Node provides the creation of a plane with fixed-point type, servo type, and object type as well as a variety of AOI identification functions. The display of a **Vision** Node in flow, in the most complicated situation, each affiliate icon is shown in the figure below: The **Base** icon on the right side is for which **Base** is to record the **Vision** node of this **Vision Job**, and the **Base** icon on the left side is for which **Base** is to be generated by this **Vision Job**.

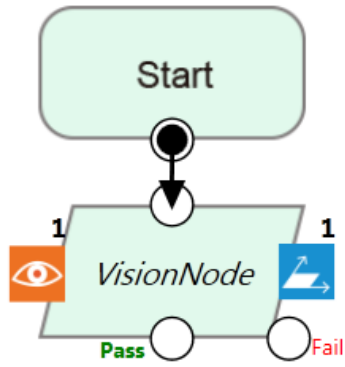

Figure 167: Vision Node

TM Robot records the relative relationship of objects by recording the points on different **Vision Bases**. If the environment changes, the robot can be compensated by coordinate transformation without re-teaching the robot's point positions. The position, as shown in the following figure, records the point P1 on the **Vision Base** to complete the task of pick, and performs the placement operation at the fixed position P2.

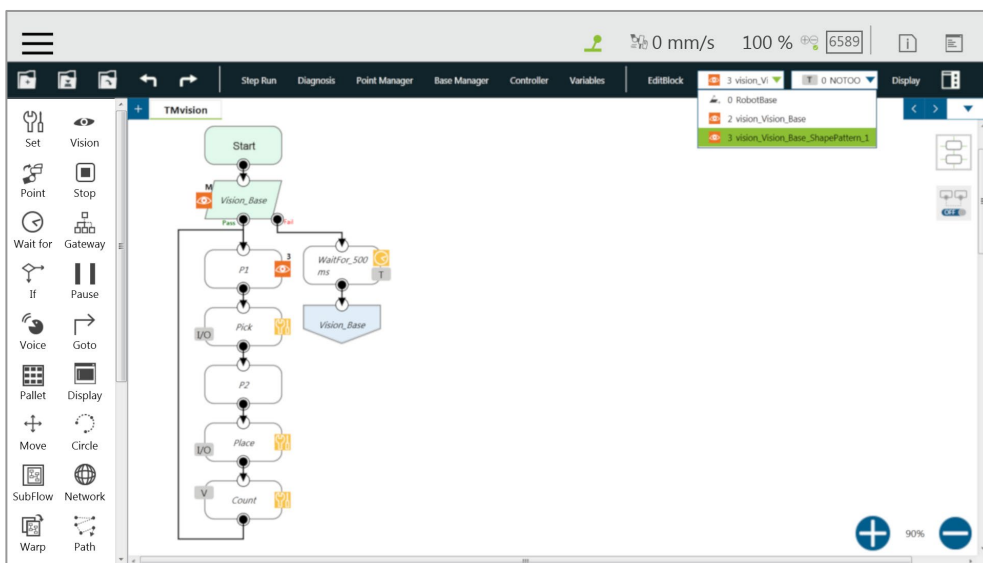

Figure 168: Vision Node Flow

Part of the vision functions can generate **Variables** such as the string of the barcode, the number of objects, the color of identify, etc. The following is a multi-object recognition function, which outputs the number of objects found. In **Line of Motion Setting**, users can check the box next to **Link to project speed** to align the speed with the project speed.

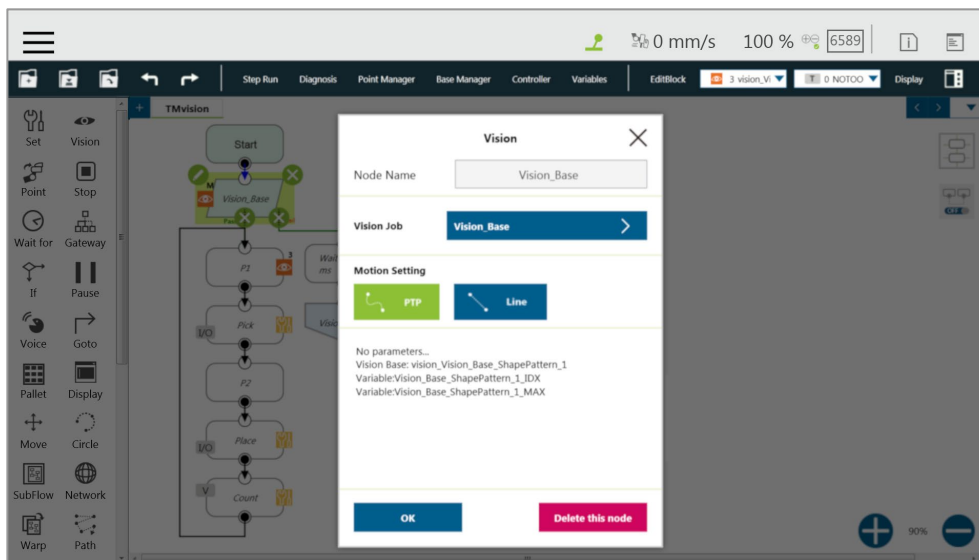

Figure 169: Vision Node Setting



IMPORTANT:

- When using the **Vision Bases**, make sure to choose the correct **Base** from the list on the upper right corner as **Current Base**.
- Do not use reserved words such as var to name vision jobs.

Refer to *Software Manual: TMvision* for further details.

12. Communication and Display

12.1 Modbus

Modbus is a Master/Slave type communication protocol. Users can use Modbus Master to read or write the parameters and save them in the robot register, such as position, posture and IO status. Users can program with the obtained parameters or monitor the status of robot. TM Robot provides two protocol versions of Modbus: Modbus TCP and Modbus RTU for users to get data from the external Modbus device or robot register. The external device, such as IPC or PLC, can also send commands to the TM Robot to get the related data as Master.

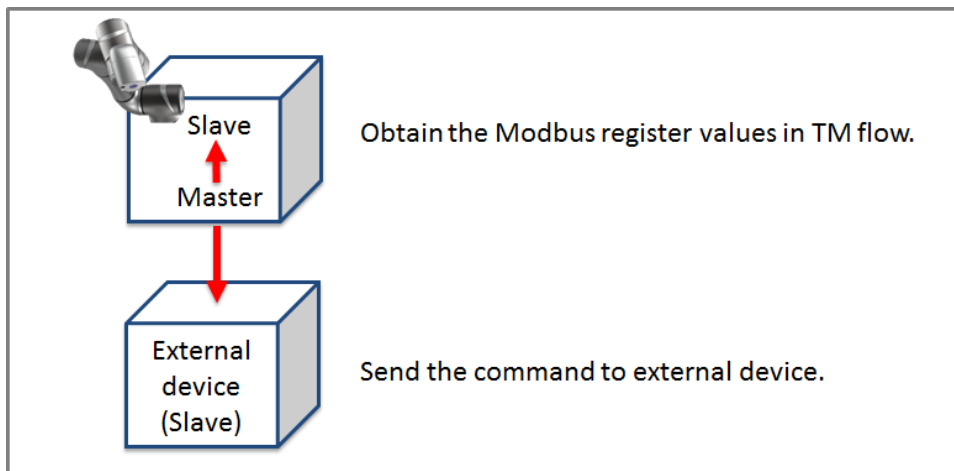

Figure 170: Robot Modbus Protocol

Note

NOTE:

Master is also called Client; Slave is also called Server.

12.1.1 Modbus System Hardware Structure

Modbus is divided into two protocol versions: Modbus TCP and Modbus RTU. Modbus TCP uses RJ45 for communication. There is only one position in the **Control Box** that can use RJ45 to perform communication of Modbus TCP: The “LAN” port marked in the *Hardware Installation Manual*. On the other hand, Modbus RTU uses a serial port for communication. Regarding the above connection approaches, refer to the instructions in the *Hardware Installation Manual* for the location of the connectors.

12.1.2 Modbus System Software Structure

12.1.2.1 Set Modbus TCP

In the **TMflow** Setting page, click **Connection** to access the **Modbus Slave** Page, users

must confirm that the IP is obtained in order to enable the Modbus TCP function. IP filter can

set the network mask, and the communication with the robot must be in the set domain.

12.1.2.2 Set Modbus RTU

In the **Modbus Slave** RTU setting page, parameters need to be synchronized with the external device before use. After the parameters are confirmed, Modbus RTU then can be opened through the **Serial Port**, allowing the robot to communicate with different devices.

12.1.3 Application of Modbus in Project

The value obtained by Modbus can be used for many applications, such as writing the robot's status to an external device via Modbus. The settings inside the TCP / RTU devices are the same. The following will use the Modbus TCP reading the robot's x direction coordinates as the example for description.

Name	FC	Address ₁₀	Address ₁₆	Type	R/W
X	04	7001~7002	1B59~1B5A	Float	R
Y	04	7003~7004	1B5B~1B5C	Float	R
Z	04	7005~7006	1B5D~1B5E	Float	R

Table 11: TM Robot Coordinates in the Modbus List

First click **Modbus Device** from the list on the right side of **TMflow** to build the relevant parameters for the TCP device.

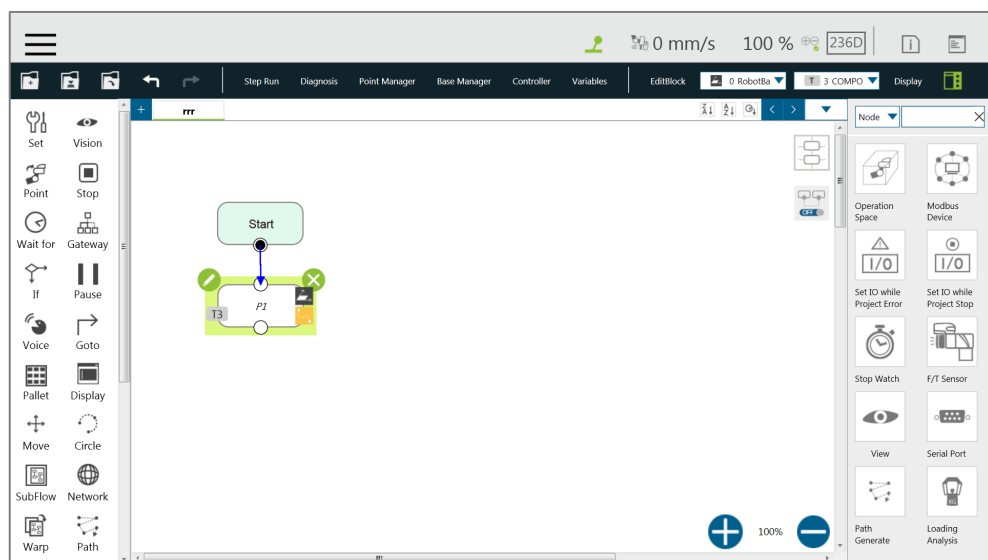

Figure 171: Modbus Device Access

After adding a **TCP** device, users can set the parameters of the **TCP** device manually, such as name, address and other related information, or import from IODD files supposed users have

imported items and checked files in **Text File Manager**. Users still have to add the Modbus Devices and communication parameters manually. The only thing that IODD files do automatically is create the Address (Signal) Settings. After completing the setting, press **OK** to save. Using **TMflow** to get the robot parameters, users can directly use the preset local IP to operate. Then, click **Edit** to add the pre-read/write location in this device.

Note

NOTE:

- To import IODD Files, make sure the files store in the path **\TM_Export\RobotName\XmlFiles\IODD** of a flash drive labeled **TMROBOT** where RobotName denotes the ID of the robot.
- To apply the imported IODD files for IO Link applications: Click the pencil icon of the item listed in **Modbus Device**, and click **Import from IODD**. Click the field next to **IODD File** to select the imported IODD file, and click **OK** when done to view the functions in **Modbus Device's Setting**.

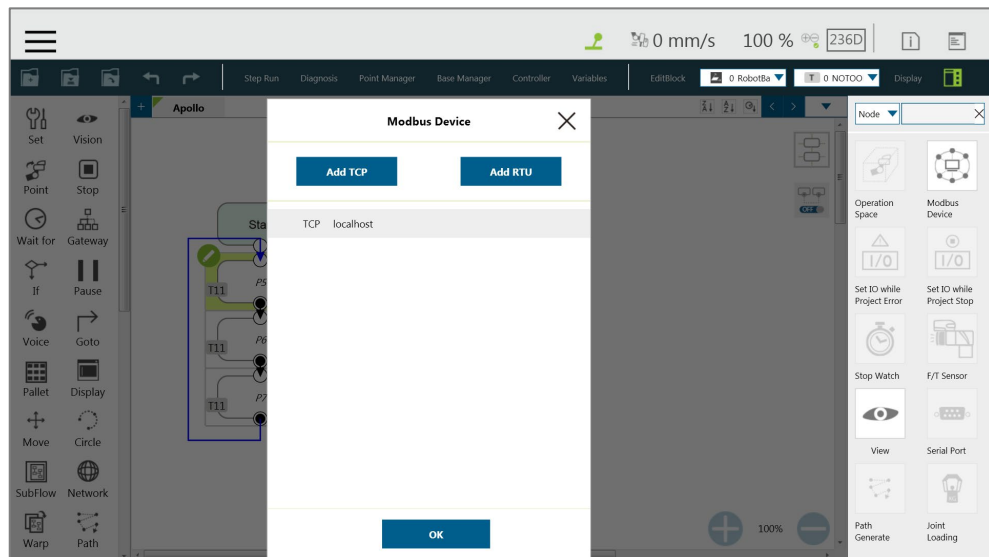

Figure 172: Modbus TCP Local IP

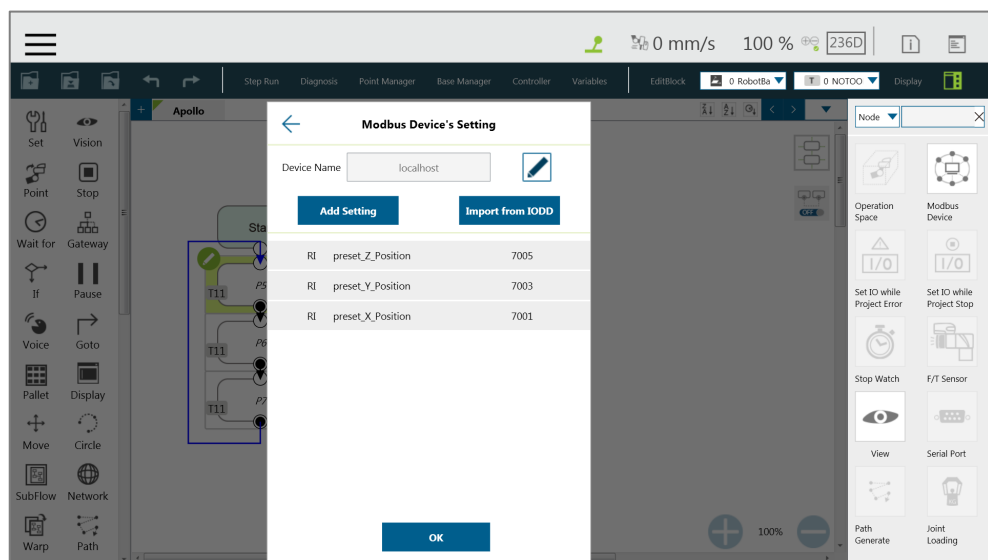

Figure 173: Modbus Device Setting



IMPORTANT:

If communicating with an external device, then it is necessary to set the IP address and related parameters of the external device.

Users can view the list of Modbus, in the lower left of the **Modbus setting page**, and input address of 7001, variable type as Float according to the list. After setting, users can program the Flow, and the subsequent maintenance can also be set using the **Modbus Device** on the right side. The following will use these settings to program Flow, and read the current X coordinate position of the robot. Users must create a variable to store the X coordinate value in the register.



IMPORTANT:

Big-endian is the high byte stored at the lowest memory address and must be checked here.

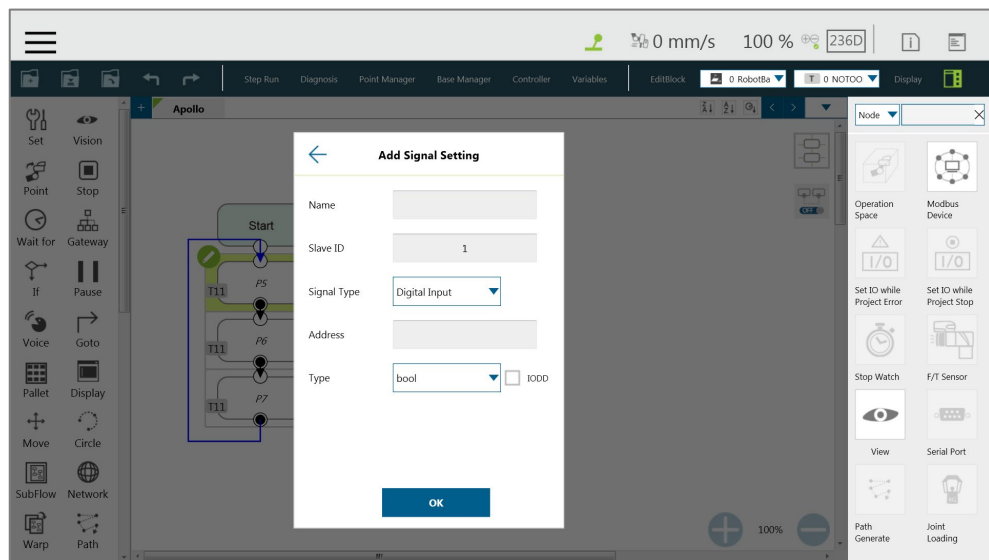

Figure 174: Modbus X Axis Position Parameter Setting

In this example, a float type variable `var_Position_X` is created, so that the variable `var_Position_X` gets the robot's coordinate value in the X direction. Use the **Set** Node to insert the new **Variables** and the **Variables** obtained by Modbus into the upper text box, and use the **Display** node to verify whether the X coordinate value obtained in the Modbus address is correct.

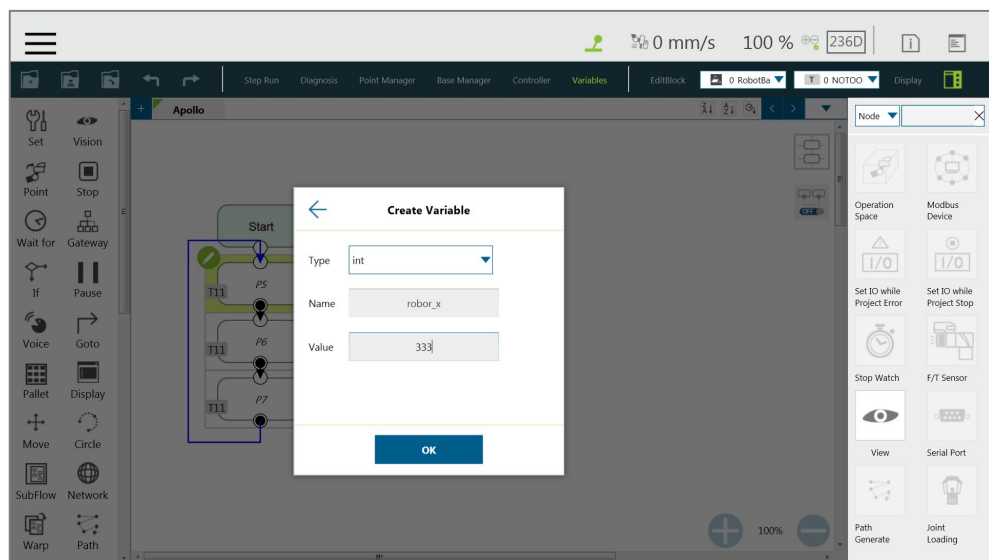

Figure 175: Save the Variable of Modbus Value

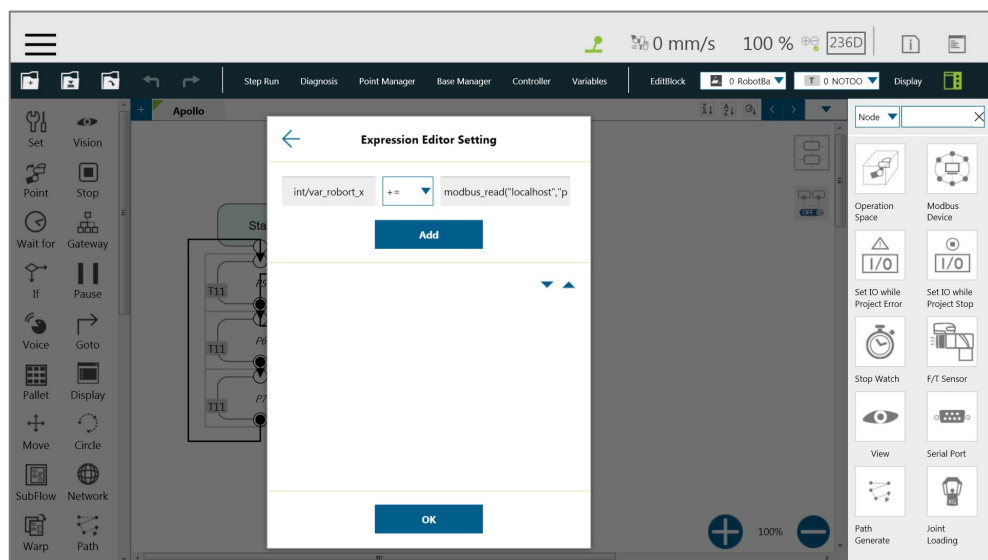

Figure 176: Use the obtained variable of SET node to obtain the value of Modbus

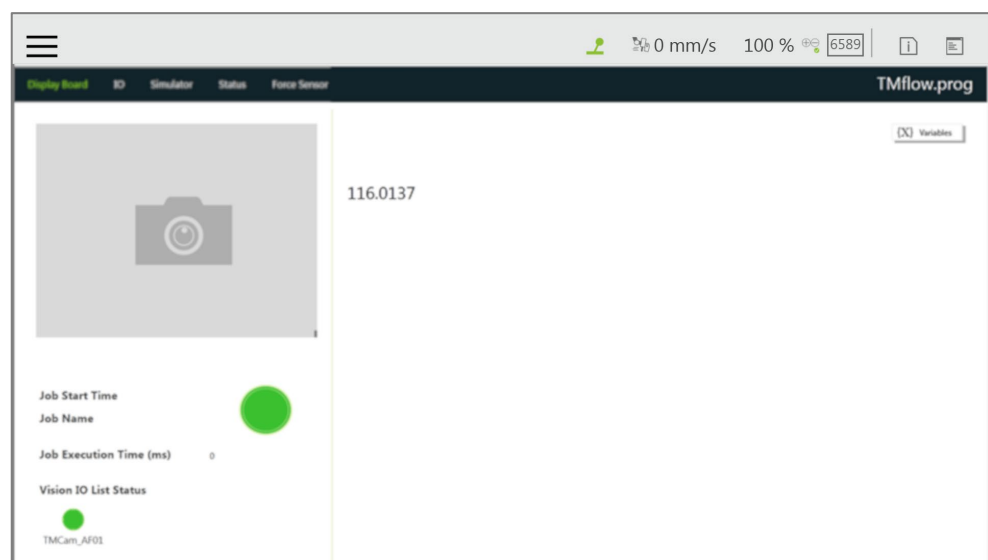

Figure 177: Display displays the value obtained by Modbus

Note

NOTE:

- The Modbus addresses for robot stick commands (Play/Pause, +, -, Stop) cannot be written to when the robot is in Manual Mode.
- Use the external device to read the Modbus address 7320~7321 for the last error code.
- The system would renew any SI/SO states on related memory address for HW 3.2 or newer exclusively.

12.2 Network

Once all network parameters in the **Network setting** are set, users can use the **Network** node to have the robot communicate with the external devices through the network. It is recommended that the external devices and the robot be on the same subnetwork.

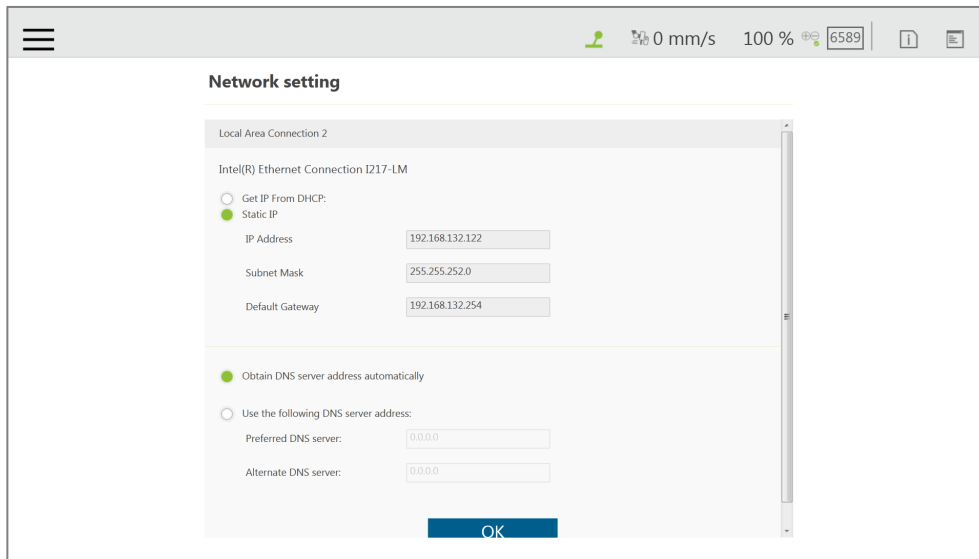

Figure 178: Network Setting

12.2.1 Network Node

The **Network** node can be set to communicate with external devices.

To set the **Network** node, follow the steps below.

1. Drag a **Network** node in the node menu to the flow editing area.
2. Click the pencil icon on the node
3. In the field of **Node Name**, fill the desired name.
4. Select the device to communicate with in the box next to **Choose Device**.
 - To add a device: Click **Add Device**. Enter the name, the IP address, the port number of the device into the respective fields, and click **OK**.
 - To edit a device, select the device in the box next to **Choose Device** and click **Edit Device**. Fill the information to edit in the respective fields, and click **OK**.
 - To delete a device, select the device in the box next to **Choose Device**, click **Edit Device**, and click **Delete**.
5. Click on the bullet to select from either **Receive from variable** or **Send** for inbound or outbound traffic.
 - For **Receive from variable**, click on the box next to **Variable** to assign a variable to store the inbound messages. In the box next to **Maximum received data time**, fill the desired maximum time in milliseconds to receive data, or click the **Var** button to select a variable to apply
 - For **Send**, click on the bullet next to **Typing** to edit the desired message in the box below or click on the pencil icon to add more expressions to the box as the outbound

message, or click on the bullet next to **Variable** and select a variable in the box to assign a variable for the outbound message.

6. In the field of **Extra Idle Time**, fill the desired time in milliseconds, or click the **Var** button and the box next to **Extra Idle Time** to select a variable.
7. If you wish to know the connection status, click on the box next to **Connection Status**, and assign a variable from the list to have the variable store the connection status.
8. Click **OK** when done.



NOTE:

The system will report an error and light in red if no device is in the node setting.

12.3 IO

TM Robot provides users with both digital IO and analog IO. Digital IO controls two states, represented by H and L (High/Low). High represents the output voltage of the **Control Box**, which is 24 V. If Low, then the output voltage will be pulled to GND.

The **Control Box** configures 16 sets of digital IOs and 6 sets of analog IOs. Users can use the **SET** node to give the AO specific voltage (-10V~10V) to complete the job in actual operation.

12.3.1 User Defined IO

Using **Self-Defined IO**, users can trigger or read the button on the **Robot Stick** with external devices through the IO ports on the **Control Box**. After the setting is complete, click **Save** in the lower right corner to save the setting.

Control Box Input channel	Meaning	Control Box Output channel	Meaning
9	Stick + button	9	Stick + button
10	Stick - button	10	Stick - button
11	Stick M/A Mode	11	Stick M/A Mode button
12	Stick Play button	12	Stick Play button
13	Stick Stop button	13	Stick Stop button
		14	System Error Indicator
15	Simulated E-Stop button	15	Simulated E-Stop button

Table 12: User Defined IO Setting Table

12.3.2 External IO

TM Robot provides external IO extension functions, which can be extended by the TM Plug &Play EtherCAT IO extension modules and the added IO interface port can be called by the controller to test, and to complete the flow programming by the **SET** node.

12.3.3 Status IO

Status IO is used when the project is stopped or in error. The status of the IO is changed to the set value according to these conditions and can be accessed from the **Project Function Menu**. Click the icon **“Set IO while Project Errors”** or **“Set IO while Project Stops”** to access the setting page.

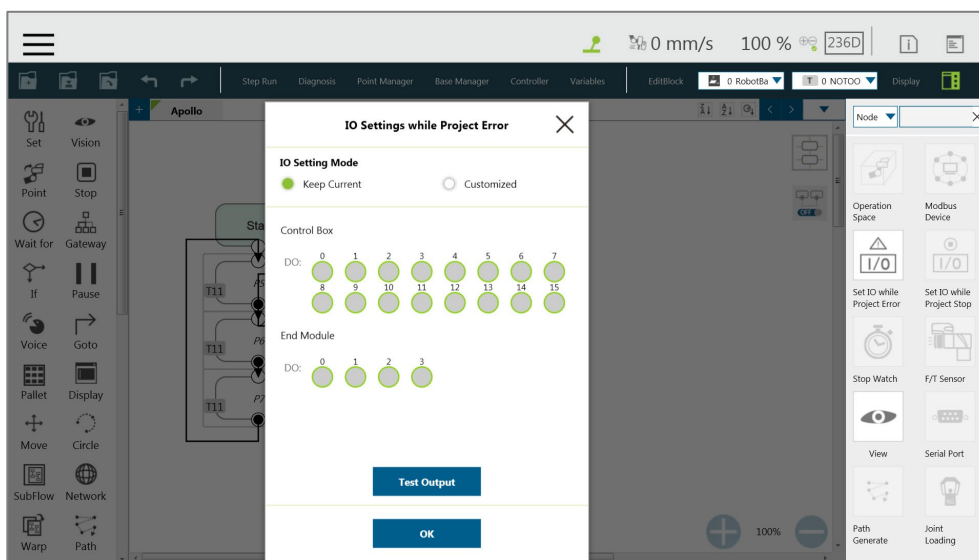

Figure 179: Status IO Setting (1/2)

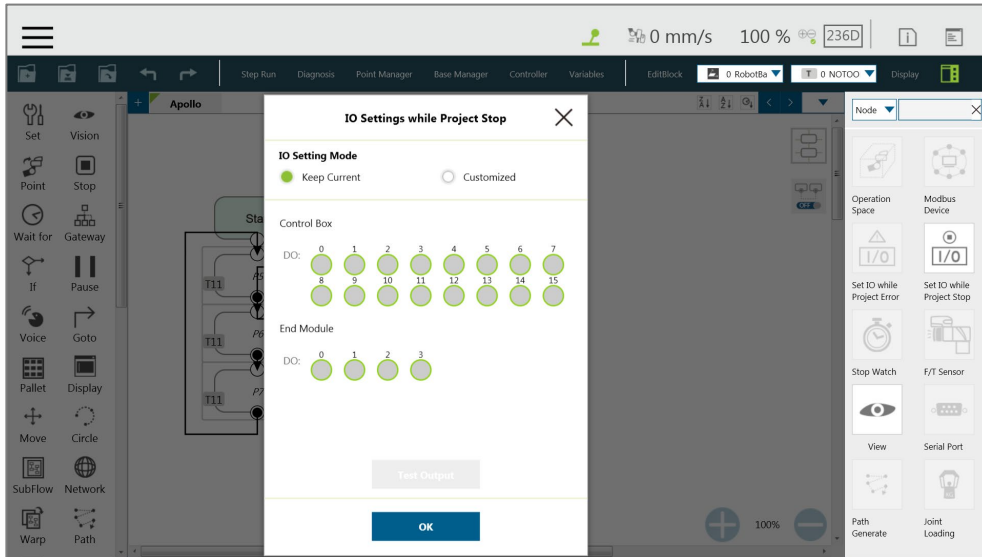
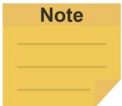

Figure 180: Status IO Setting (2/2)

12.4 Command Node

For special applications, such as reading a file, RS232 data, and other functions, users can import the executable file into the robot and use the **Command** Node to call the **Shadow Server**. The **Shadow Server** should be slave while the **Command** node in the flow is Master. There are 2 built-in **Shadow Servers: File** and **TmComm** which will be introduced in the following section.



NOTE:

- Enabled or disabled items in the command list will take effect only after each power cycle.
- The system will report an error and light in red if no device is in the node setting.

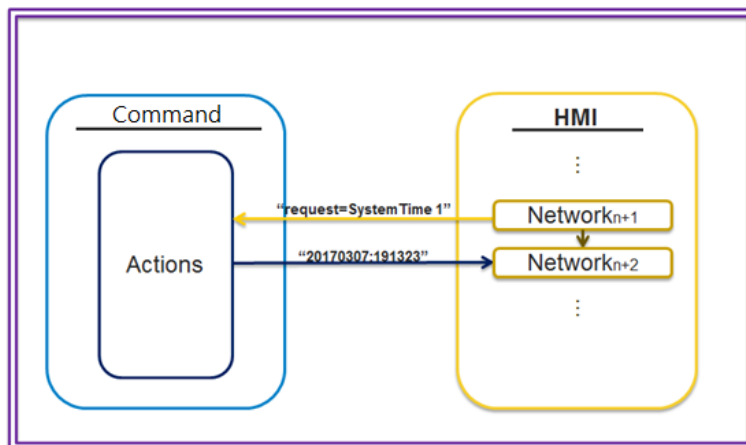

Figure 181: Instruction Set Communicates with HMI

Navigate to and click **Setting** > **Command** to enable TmComm Instruction Set in **Command List**.

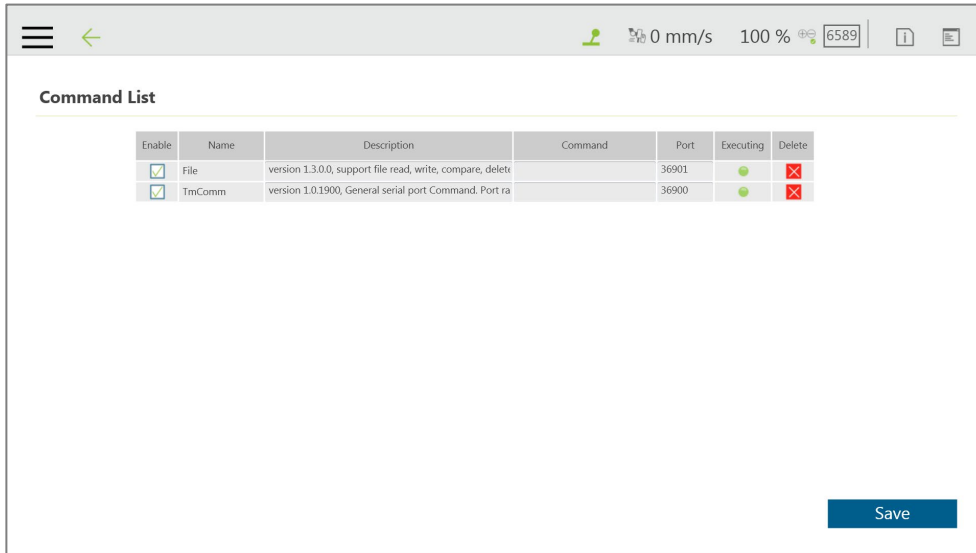

Figure 182: Enable TmComm Instruction Set

12.4.1 TmComm Instruction Set

The **TmComm** instruction set can read and write strings to the RS232 communication terminal. Before use, it is necessary to ensure that the **TmComm** in the instruction set is enabled. After confirming that it is enabled, click Command Port 36900 inside the flow and use the Command node to send corresponding strings or variables to this Port, and create a string type variables to accept the returned results.

ComSet	Function	Set the serial port, the following parameters are port name, baud rate, parity, data bits, stop bits
	Example	ComSet = 3 9600 n 8 1 3: Set as Com3 9600: baud rate [n e m o s]: Checking code, n:None, e: Even, M: Mark, o: Odd, s: Space 8: Length of data 1: stop bit
ComOpen	Function	Open the set Serial port, you must first open before you can transfer data
	Example	ComOpen = 3 3: Set as Com3
ComWrite	Function	Write data to the serial port
	Example	ComWrite = 3 John is good boy. 3: Set as Com3 John is good boy.: The first non-blank visible character after serial port number 3 is the data start command
ComRead	Function	Read the data in the current serial port
	Example	ComRead = 3 3: Set as Com3 * This command will read all data of the buffer in the command serial port

		<p>number and send it back.</p> <p>It is recommended to first check whether there is enough data in the buffer to read, in order to avoid reading the data but unable to identify it.</p>
ComReadAfter	Function	Take serial port data and remove the starting specified string
	Example	<p>ComReadAfter = 3 abc</p> <p>3: Set as Com3</p> <p>abc: Specified string</p> <p>*This command will read all the data of the buffer in the command serial port number and send it back. It is recommended to check whether there is enough data in the buffer to read, in order to avoid reading the data but unable to identify it.</p>
ComClose	Function	Close serial port
	Example	<p>ComClose = 3</p> <p>3: Set as Com3</p>
ComCheckBuffer	Function	Check the serial port buffer data length
	Example	<p>ComCheckBuffer = 3 eq 5</p> <p>3: Set as Com3</p> <p>[eq le ge lt gt] eq: =, le: <=, ge: >=, lt: <, gt: ></p> <p>5: Data length</p> <p>Check whether the length of the data in the Com3 buffer is equal to 5</p> <p>*return: [y n]</p>
ComClearBuffer	Function	Clear the unread data in the serial port
	Example	<p>ComClearBuffer = 3</p> <p>3: Set as Com3</p>
ComReadPos	Function	Take the serial port content, return the specified length of data after the specified address
	Example	<p>ComReadPos = 3 15 4 8</p> <p>3: Set as Com3</p> <p>15: Total read length</p> <p>4: Return data from the fourth character (counting from 0)</p> <p>8: Specify the length of returned data</p> <p>Assume that there is information 123456789ABCDEFKKK in the buffer of the current serial port3</p> <p>The instruction ComReadPos = 3 15 4 8 will read the first 15 (123456789ABCDEF) characters, leaving only KKK three characters in the buffer area.</p> <p>At the same time, the 8-character length data (56789ABC) will be returned from the 4th character.</p>

Table 13: TmComm Instruction set

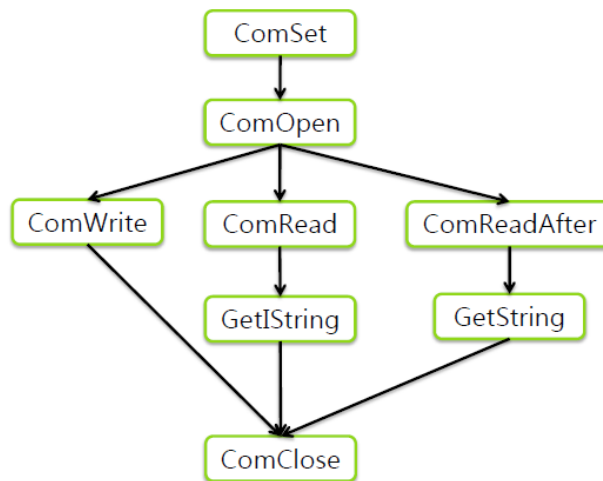

Figure 183: Directive Summary Flow

In this example, insert the RS-232 into Com1 of the TM **Control Box**, and communicate with the robot using RS232. After the obtained values have been processed with data analysis, the results will be displayed on the **Display Node**.

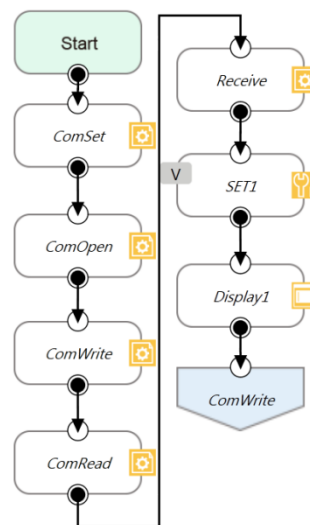

Figure 184: Command Node Gets RS-232 Information

ComSet is used to set the serial port. After setting, **ComOpen** will open the set serial port again. In order to avoid overload, the process can be used with a **WaitFor** node as the interval, or use the wait time in the **Command** node as the interval. After **ComOpen** is opened, if no more strings are required to request data, then set the serial port to read and use the string to receive.

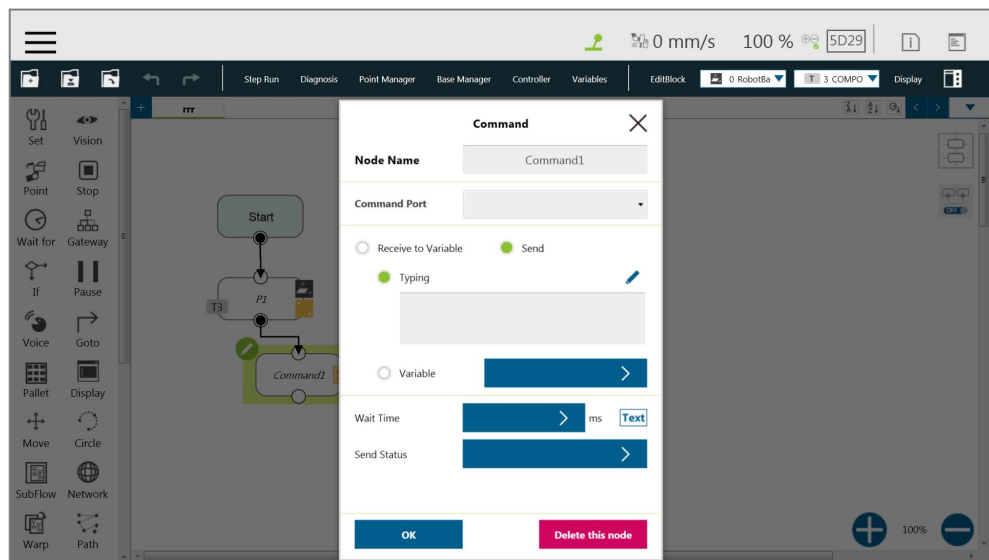

Figure 185: Set and Open Serial Port (1/2)

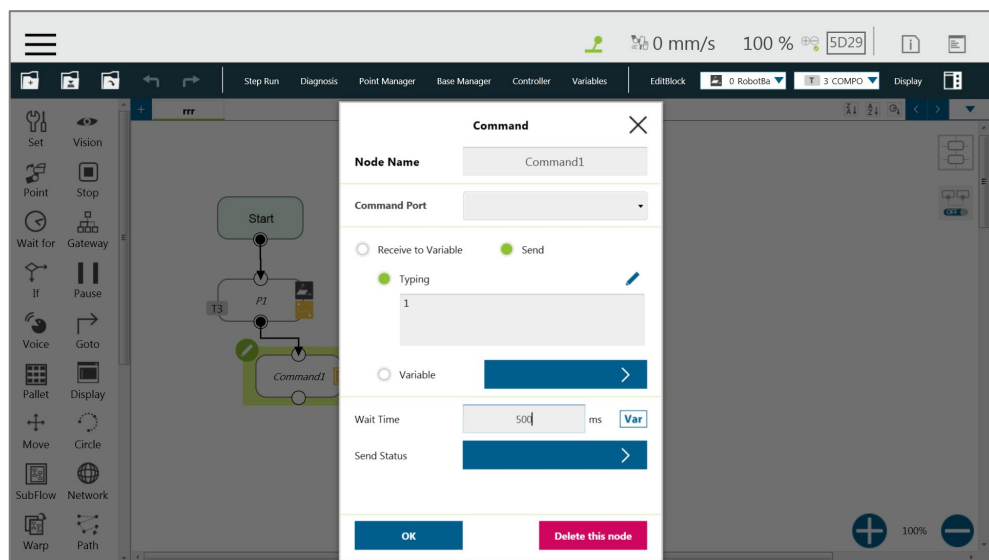

Figure 186: Set and Open Serial Port (2/2)

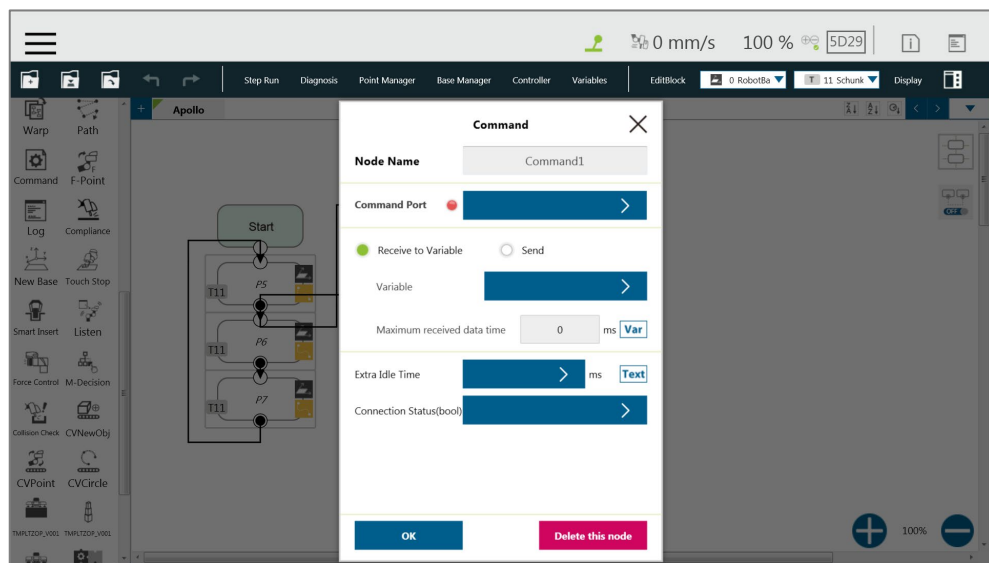
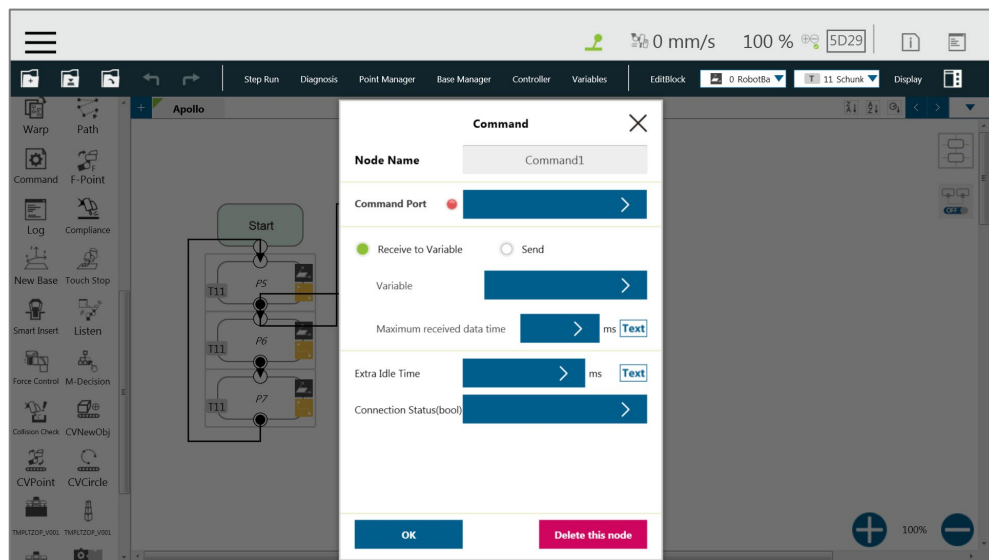

Figure 187: Read Data and Receive as a Variable

At this time, the variable var_receive will receive a string of characters. Users can conduct string disassembly, type conversion, analysis conversion, etc., according to the protocol of product specification to convert it into a readable state and use it as **TMflow** variables. Click the field next to **Command Port** to select the port in the **Command List** to apply. In the box next to **Maximum received data time**, fill the desired maximum time in milliseconds to receive data, or click the **Var** button to select a variable to apply. In the field of **Extra Idle Time**, fill the desired time in milliseconds, or click the **Var** button and the box next to **Extra Idle Time** to select a variable to apply.

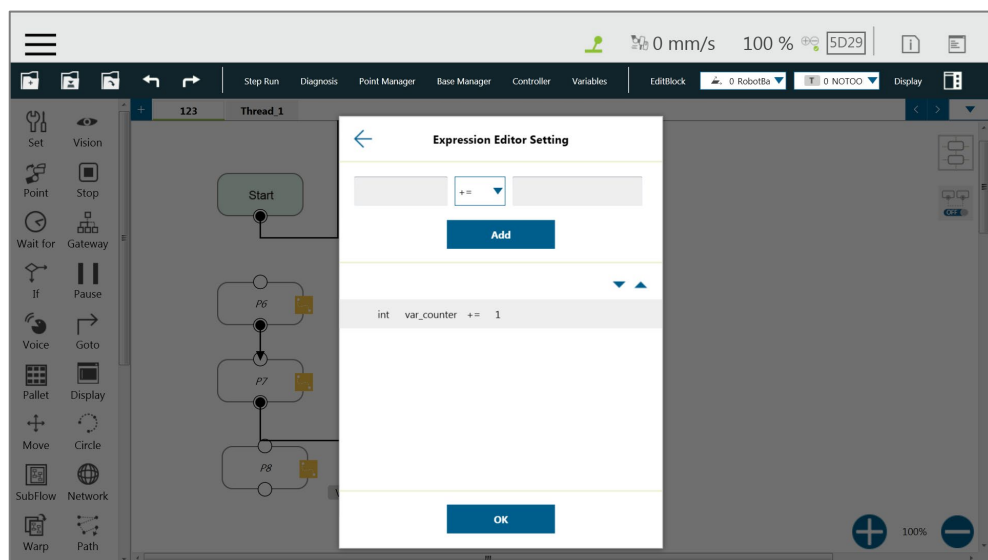

Figure 188: SET Node Setting

Finally, the obtained value is displayed on the screen using the **Display** node, and the **Goto** node is used to update the value continuously.

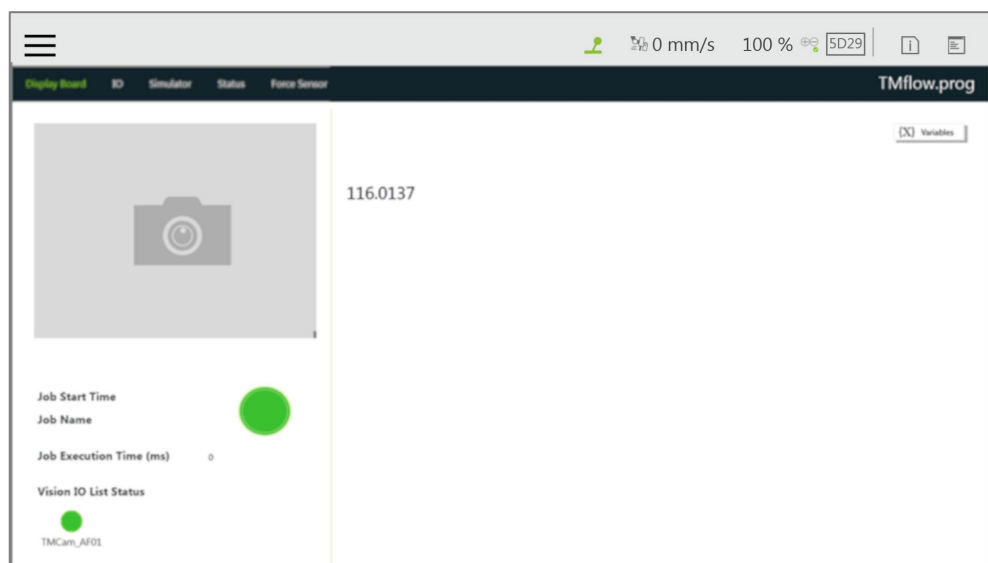

Figure 189: Display Node Displays the Obtained Value



NOTE:

The **Network** node can function exactly like the **Command** Node by using the localhost IP address (127.0.0.1) and the command port number (e.g. 36900 for TmComm command).

12.4.2 File Command

The **File Command** provides users with operations of reading, modifying, and deleting files in the

shared folder. Users can communicate with the robot through RJ45. Confirm that it is enabled from **Command List** before using. After confirmed, use the **Command** node to send corresponding strings or variables to this port, and create string type variables to accept the returned results, and complete the flow programming with this concept.

Write	Function And Example	<p>Add 001.txt to file folder on the remote computer and write test=001</p> <p>Write = 1 1 \\169.254.158.75\file\001.txt test=001</p> <p>1: mode, currently fixed at 1</p> <p>1: Write mode, 1 is to generate a new file for writing, 2 is to write an existing file</p> <p>\\169.254.158.75\file: write target (IP location and folder)</p> <p>001.txt: text file name to be written</p> <p>Test=001: What to write</p> <p>Successful write will return: \\169.254.158.75\file\001.txt</p> <p>Error return content:</p> <p>Command length error:illegal parameter</p> <p>File path error: FILEEMPTY</p>
Delete	Function And Example	<p>Delete 001.txt in remote computer file folder</p> <p>Delete = 1 1 \\169.254.158.75\file\001.txt all</p> <p>1: mode, currently fixed at 1</p> <p>1: delete mode, 1 delete file, 2 delete the specified content in the file</p> <p>\\169.254.158.75\file: Delete target (IP location and folder)</p> <p>001.txt: text file name to be deleted</p> <p>All: constant</p> <p>Example 2: 001.txt in the remote computer's file folder, delete test=001</p> <p>Delete = 1 2 \\169.254.158.75\file\001.txt test</p> <p>Success return content:</p> <p>None</p> <p>Error return content:</p> <p>Command length error:illegal parameter</p> <p>File path error: FILEEMPTY</p> <p>No deletion specified in the file: Delete Failed</p>
Read	Function And Example	<p>Read</p> <p>Example 1: Reading the contents of 001.txt in the remote computer's file folder (example: test=001)</p> <p>Read = 1 \\169.254.158.75\file\001.txt test</p> <p>1: Read variable value</p> <p>\\169.254.158.75\file: Read target (IP location and folder)</p> <p>001.txt: text file name to read</p> <p>Test: content to read</p> <p>Success return content:</p> <p>Variable content, such as example 1 will return 001</p> <p>Error return content:</p> <p>Command length error:illegal parameter</p> <p>File path error: FILEEMPTY</p> <p>No specified content read in file: KEYWORDEEMPTY</p>

Search	Function And Example	<p>Search for the existence of 001.txt in the remote computer file folder</p> <p>Search = 1 \\169.254.158.75\file\001.txt</p> <p>Definitions:</p> <p>1: search file</p> <p>\\169.254.158.75\file: Search target (IP location and folder)</p> <p>001.txt: text file name to search for</p> <p>Success return content:</p> <p>File exist</p> <p>Error return content:</p> <p>File path error or file does not exist: FILEEMPTY</p>
--------	----------------------------	--

Table 14: File Commands

The method of using **File Command**, using write/delete as an example: In **Command** node, **Send Input** writes instruction, then receives the **Write** return result through the new **Variable**. In this example, a string type **Variable, receive**, is added. Use the **Command1** node to create a text file with filename of TM_Robot in the location of 168.254.158.74. The text file content is text=001, and in Command2, use receive variable to receive **File Command** for the return value of **Command1**. Use the **Display** node to display the received value receive on the screen.

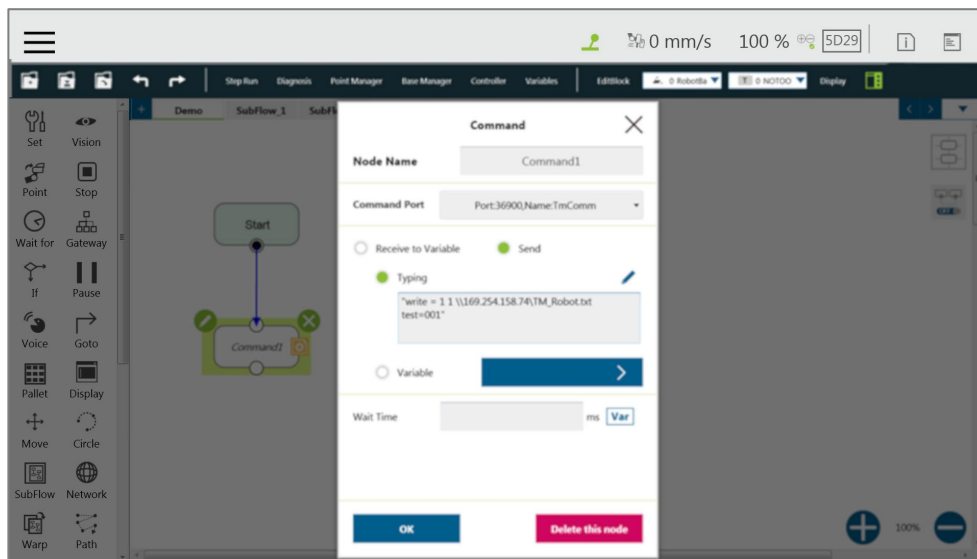

Figure 190: Remotely Add Notepad and Write information

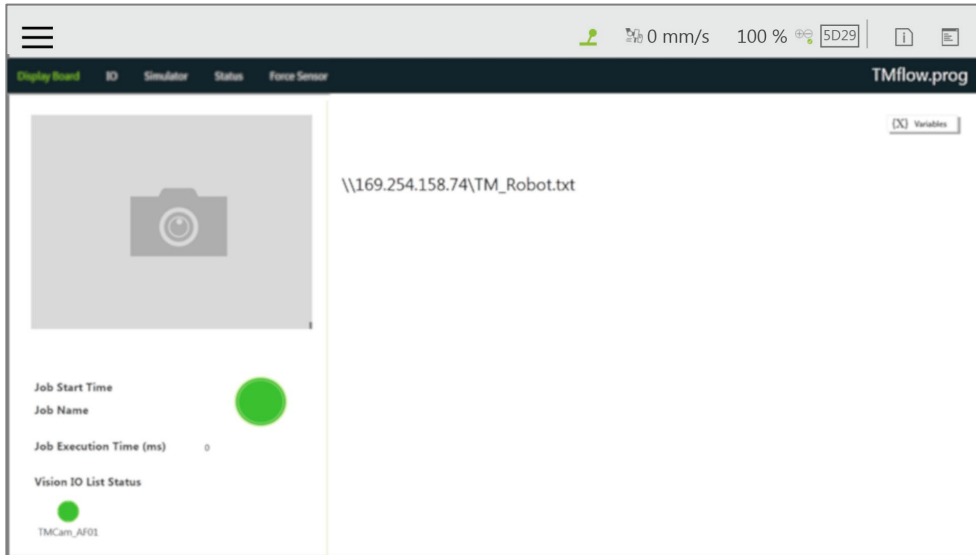

Figure 191: Display Node Displays Received Variables

In the example of figure below, In **Command1**, send delete command to delete text file with filename of TM_Robot in the location of 168.254.158.74.

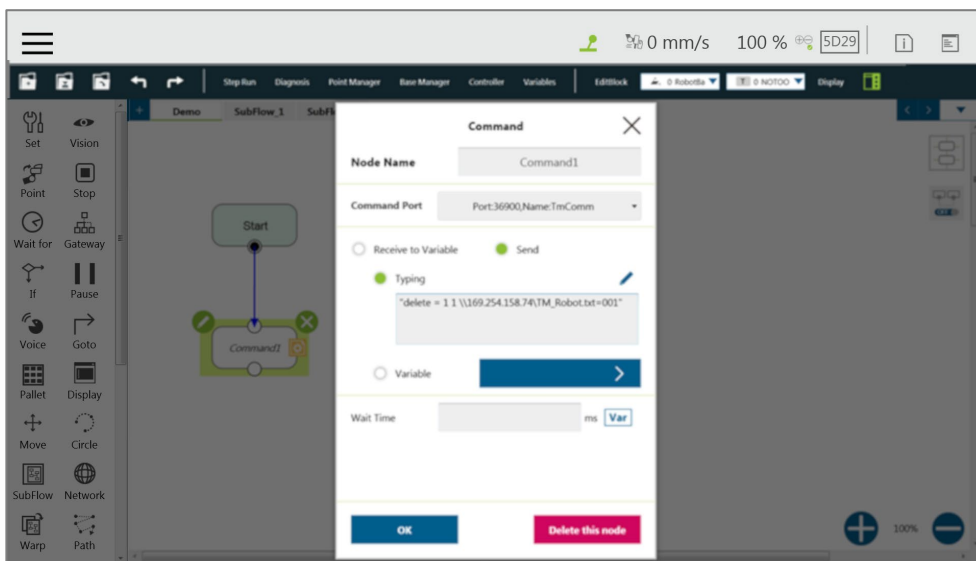

Figure 192: Remotely Delete Notepad File



NOTE:

The **Network** node can function exactly like the **Command** Node by using the localhost IP address (127.0.0.1) and the command port number (e.g. 36900 for TmComm command).

12.5 Log Node

The client end can set up the network to create shared folder and communicate with the robot through the LAN. In the project, the set **Variables** and strings can be saved to this shared folder with this Node.

The users can use their own computers to view the history messages stored in the **Log** Node in the Shared Folder. As shown in the figure below, the robot motion is programmed in the main flow, and the **Thread** constantly takes its angle information using Modbus to write the angle information into the text.

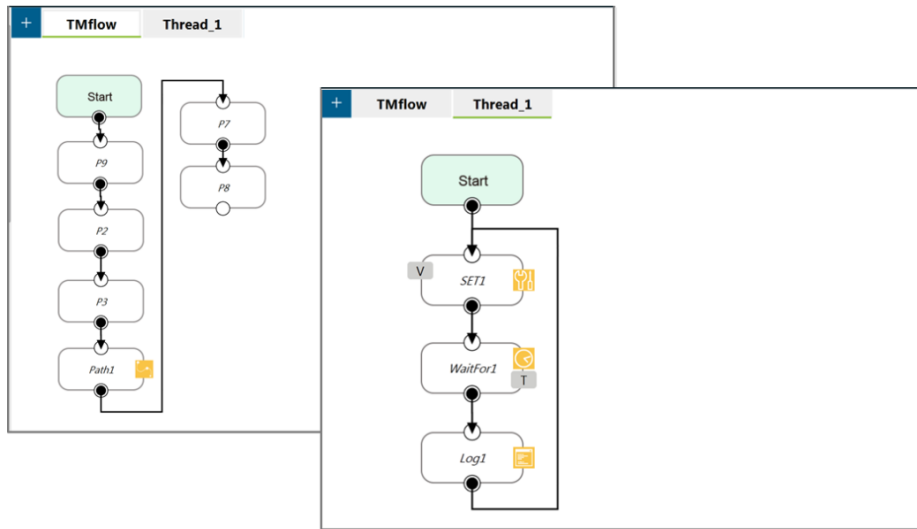

Figure 193: Log Node Gets the Current Angle

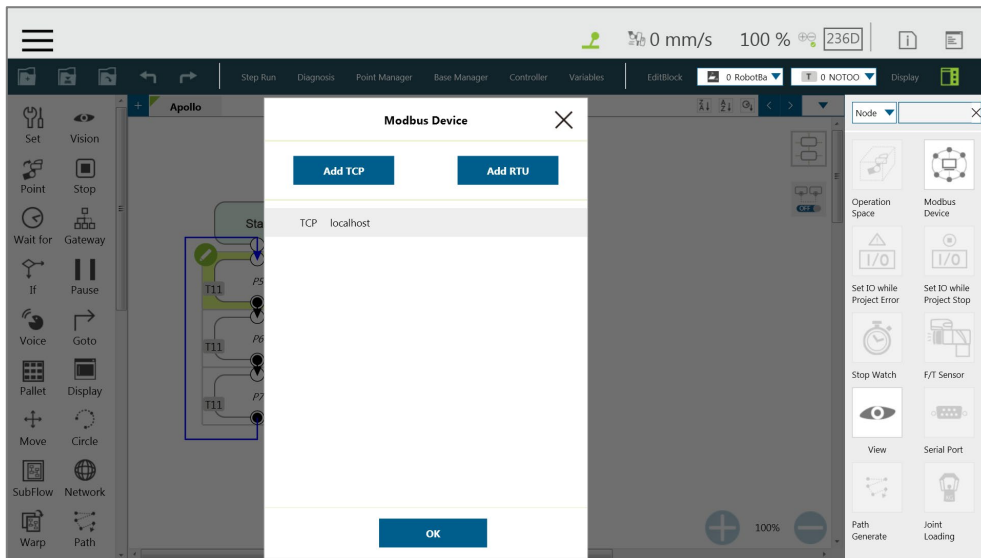

Figure 194: Modbus Setting



NOTE:

In the **Content** field of the log node, user can input text or click the **Var** button to select a variable to apply. The variable list comes with the data type of the variable.

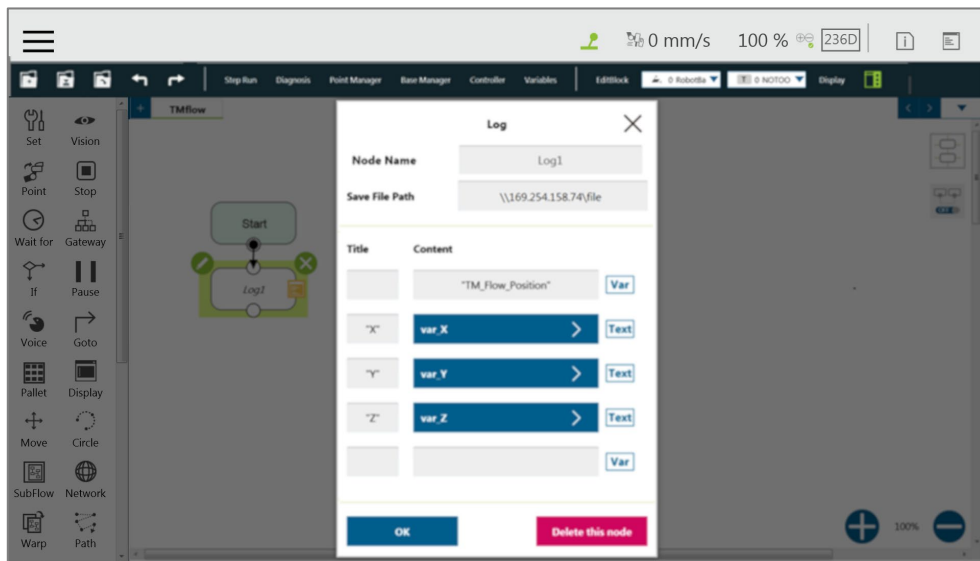
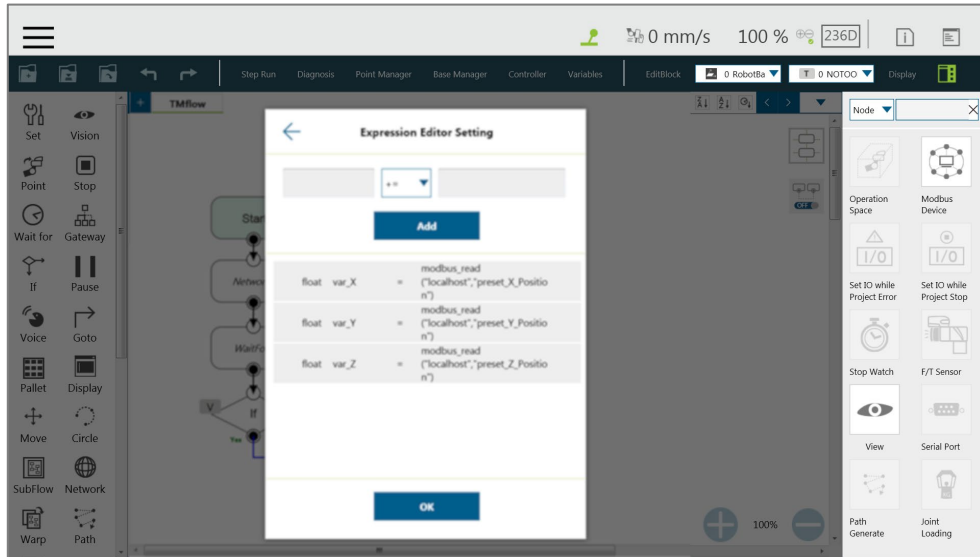

Figure 195: SET Node Setting and Log of Thread Page

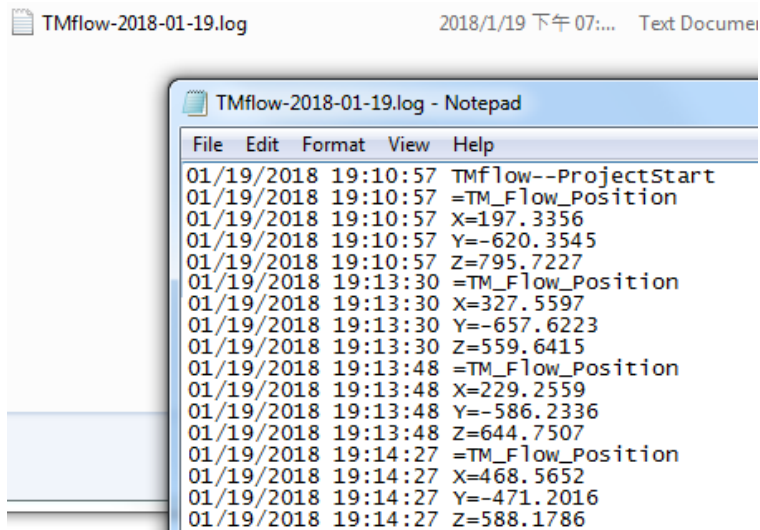

Figure 196: Node Text Example

12.6 Display Node

The function of the **Display** Node is to display the specified variable or string on the screen according to the format specified by users. For example, it can be used to display the state of variables, the value obtained by the serial port, the parameters of the robot, or the results of running. In addition, the **Display** area can change the background color and text color, users can change the color according to the results, and seven colors are supported: red, green, blue, yellow, black, white and gray.

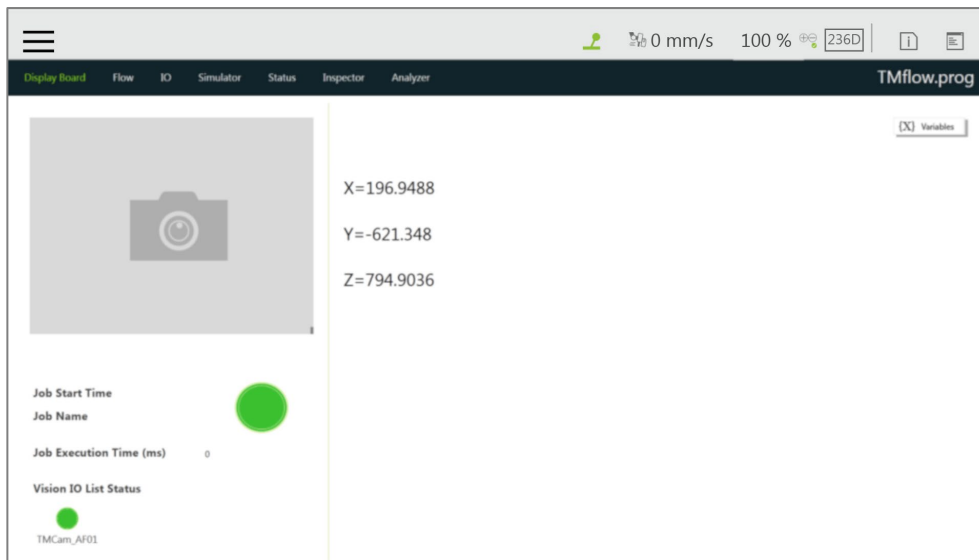

Figure 197: Display Node Displays the Robot's Position

12.7 Voice Node

When running through **Voice** Node, the speakers, headphones and other devices can be used to broadcast the set of text or variables. According to different usage, it can be divided into talking while moving (**Speak and Move**), or moving after finishing talking (**Speak, then Move**). The syntax is the same as that of the **Display** Node.

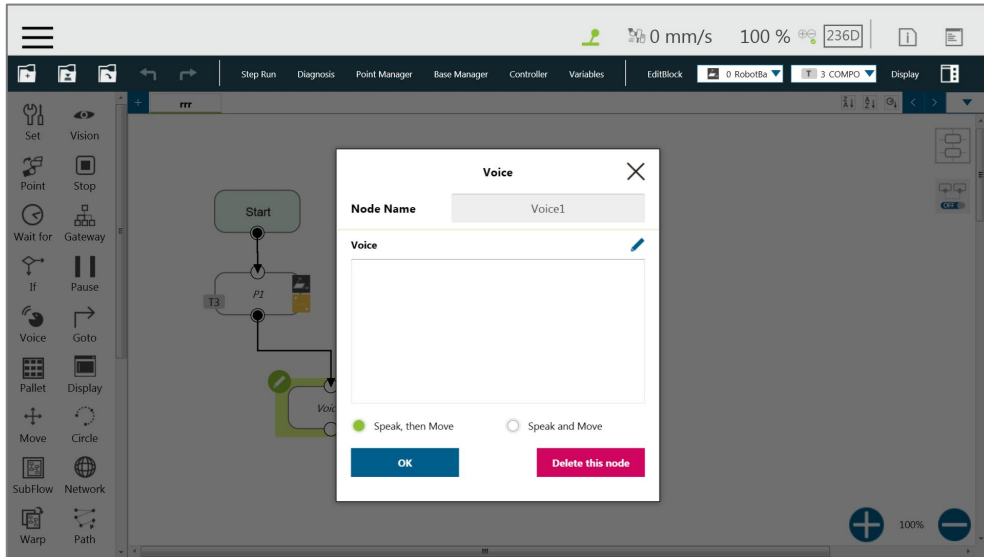

Figure 198: Voice Node in TMflow Application

For example, users can create a string type variable Hello, and input the combination of **Variable** and string in the **Voice** node. At this time, the external broadcast device will say “Hello World” according to the setting. Be careful that if a space is not added in front of World, then it will become "HelloWorld", and the result with this error will be different from the expected result.



IMPORTANT:

If using **Speak and Move**, the speech will be saved into a buffer and deleted only if the system finished speaking it. That means, if the **Voice** is used in a **Thread** with a quick loop, the buffer size will increase rapidly, that the robot might keep speaking without end.

13. Component

Component is an independent software package for the robot applications. For TM Plug&Play supported items, users do not need to write additional programs or dig into technical documents of both parties before integrating, but import the software package to use in **TMflow** directly. Place the downloaded component in the folder named **TM_Export** in root directory of a USB drive labeled with **TMROBOT**. Insert the USB drive into to Control Box and navigate to **≡ > System > Import/Export** to import the component onto the robot.



NOTE:
The file path for every type of file that can be Imported/Exported by the TM robot is as:
TMROBOT:\TM_Export\RobotName\FileType\FileName .
The path names in bold font must follow an exact, case-sensitive naming convention and the others can be named and renamed as users please.

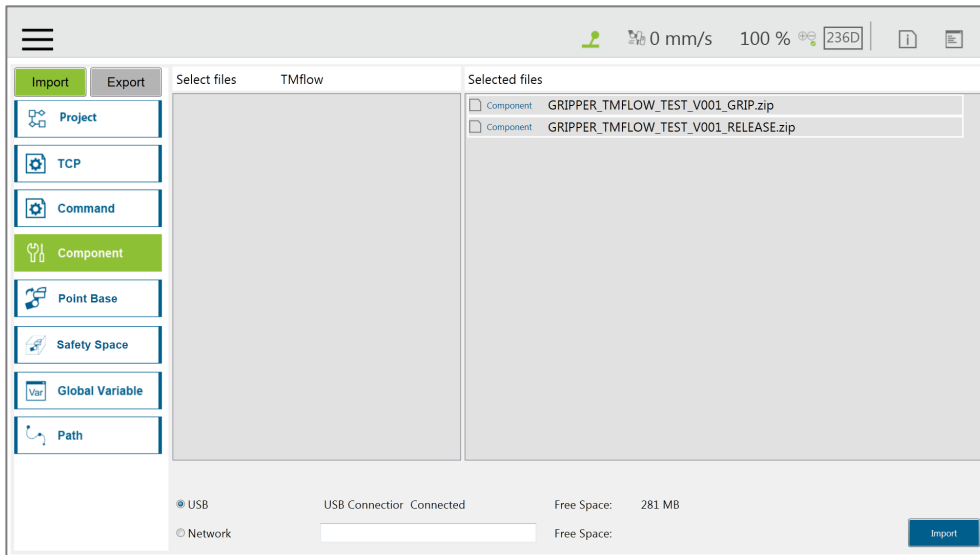

Figure 199: Select Components

After importing, the software package must be activated in the Component List by navigating to **≡ > Setting > Component** before using. Once activated, the imported software package will be added to the left side of **TMflow**, and users can use it directly by dragged it to the flow.

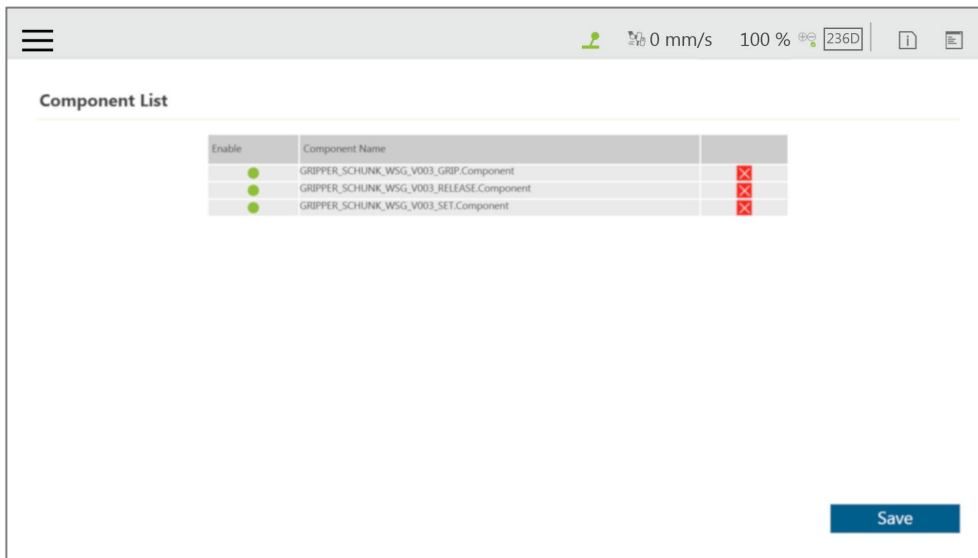

Figure 200: Robot Setting Page Component

The setting parameters of each component are not the same. Refer to 16.1.2 TM Component Editor settings for details.



IMPORTANT:

Certain **Components** need to use the **Command** to communicate with the robot. When the certain component is imported, the corresponding **Command** will be added in the **Command** list. Confirm whether the corresponding instruction set is enabled.

TMflow provides a simpler process programming method for the gripper-type software packages. On the robot setting page, click the **Gripper Button** to set the job triggered by the **Gripper Button** at the **End Module**. The concept is when pressing the **Gripper Button**, a set of **Component** is added in the flow and executed once, and two **Components** are used in sequence (remember that some of the grippers need to be executed with **SET Component** to be applicable). In practical applications, the robot uses the **FREE Button**, working with the buttons of **End Module** record the gripper and point, to complete flow programming without **TMflow** control.

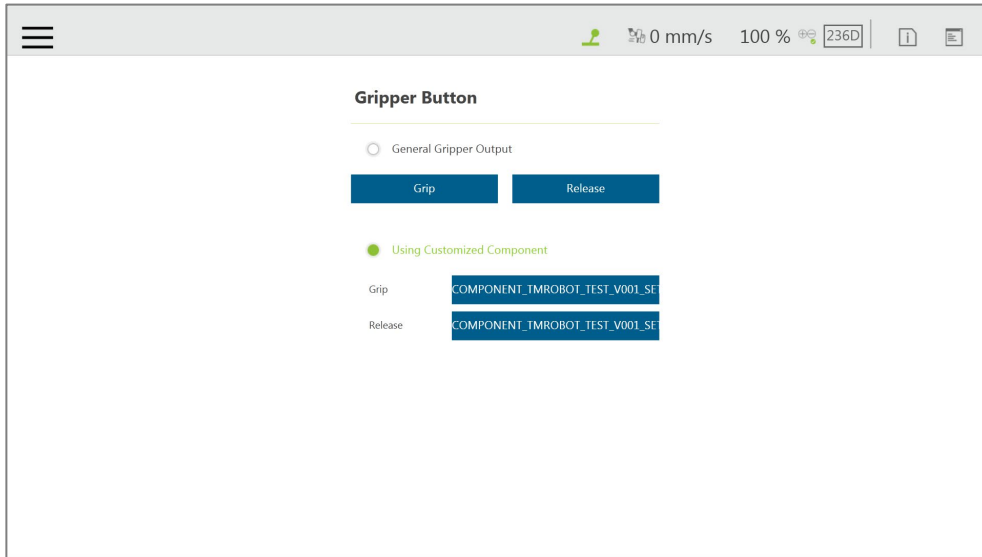

Figure 201: Gripper Button Setting Page

For making components, refer to 16 TM Component Editor.

14. Force Related Node



NOTE:
 In the force related nodes, users can set the target force for the robot to operate based on the reference coordinate to. However, the reading of F/T graph and parameterized objects is the force sensed by the F/T sensor concerning the reference coordinate in the nodes. According to the law of action and reaction, the sensor reading will equal to a negative value of the target force for the robot to operate.

14.1 Compliance node

The **Compliance** node can set the force limit on the robot movement along a single axis. This setting can be used for various applications of collision testing, object assembly, and object searching. Users can determine the direction of robot motion based on the **Tool** or the **Base**.

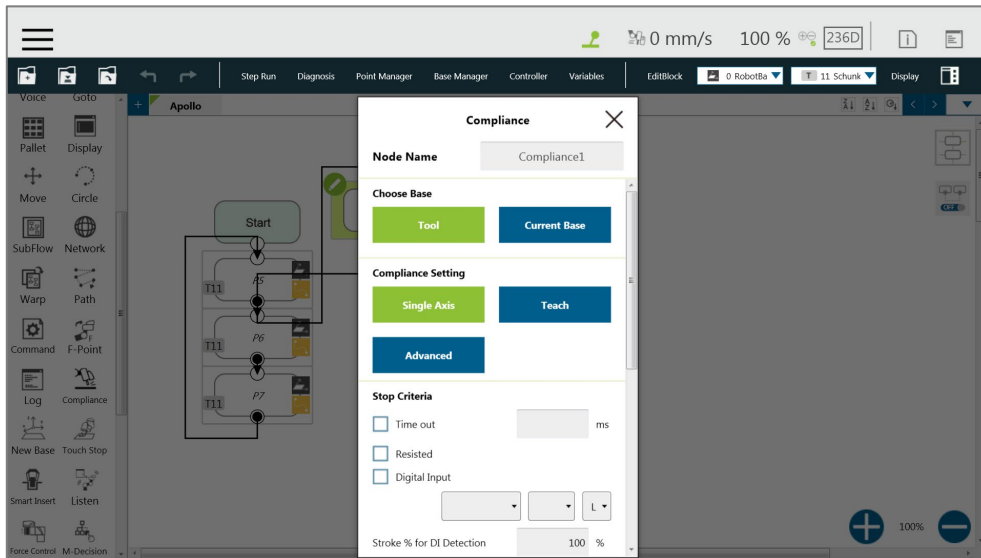

Figure 202: Compliance Node

- **Choose Base:** Select **Tool** or **Current Base**, and click **OK** to have the robot move accordingly
- **Compliance Setting:** Select **Single Axis** to define the direction (axis), distance, target force/Torque, speed of the compliance, **Teach** to use manual teaching method, or **Advanced** to define force/torque, distance limit, and target speed for applicable directions of the compliance.

Single Axis

Direction:	X, Y, Z, Rx, Ry, Rz For (X, Y, Z), the parameters are in (mm, N, mm/s)
------------	---

	For (Rx, Ry, Rz), the parameters are in (degree, mNm, degree/s)		
Force limit:	30~150 N	Torque limit:	5000~15000 mNm
Linear speed limit:	30~100 m/s	Angular speed limit:	30~180 degree/s

- **Stop Criteria:**
 - **Timeout:** This node will be released if the set time is reached before or while running the job
 - **Resisted:** When the resistance is sensed, the speed at the robot end is close to zero, and the node is released
 - **Digital Input:** Set a digital input signal to release this node once a specific DI is triggered
 - **Stroke % for DI Detection:** Applicable to **Single Axis** and **Teach**. Detects DI along the moving distance in the single axis. Stops and outputs the variable with Error (6) if DI is detected below the stroke percentage. Stops and outputs the variable with IO Triggered (4) if DI is detected above the stroke percentage.
 - **Analog Input:** Set an analog input signal, when met, this node is released
- **Others**
 - **Output Variable:**

An int variable can be used to show the result of the Compliance, meaning which criteria has been triggered in the first place, and should have the following possibilities:

 - 2: Timeout
 - 3: Distance Reach
 - 4: Digital Input (or Analog Input) triggered after the Stroke %
 - 5: Resisted
 - 6: ERROR (including TCP speed over limit, incorrect timing of DI triggered, and etc.)
 - 14: Over Speed
 - **Change payload to:** Define the payload on TCP if any payload existed
 - **Compliance Duration when Stop:** Set the length of the time to switch between force control and position control. Defaults to 200, the value is valid between 0 and 1000 as an integer and supports the variable setting.
 - **Resistance on non-target motion direction:** Reduce the vibration of the robot. Set to **High Resistance** for applications with great reactions against the robot TCP.
- **Test:** Test the performance. The robot will actually start moving at 3% of project speed when this button is pressed.

The compliance settings of the Node comes with: **Single Axis**, **Teach**, and **Advanced**. Refer to the example description in this Section for single axis. For teaching, the **Compliance** node can choose to

teach with line direction or rotation direction. Users can use the two points of teaching to perform relative movement to complete the assembly, collision and other jobs. After setting the relevant parameters, users can specify the speed of motion and other additional stop conditions in the motion mode, to ensure that the tool will not be damaged. In the **Compliance** mode, the safety settings still function.

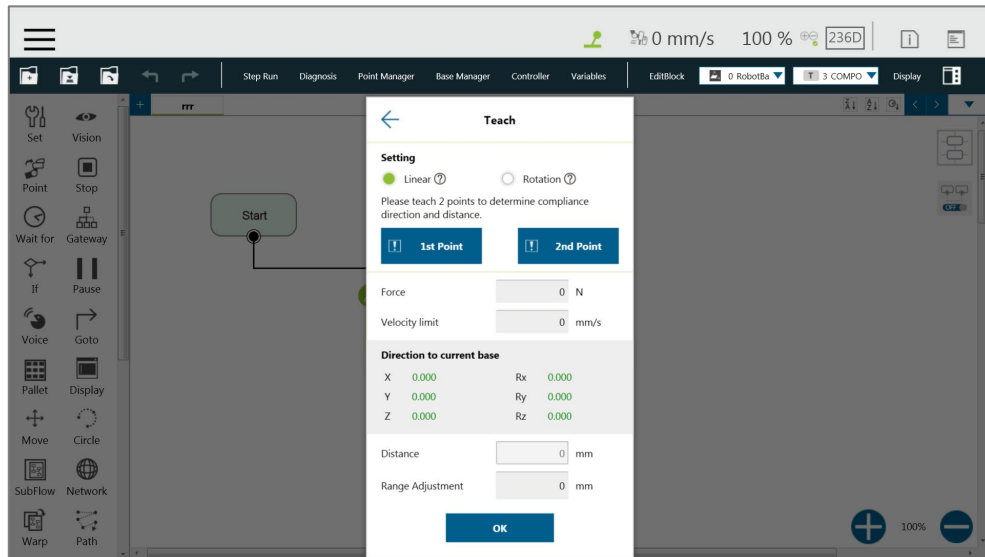

Figure 203: Compliance Node Teach Setting

- **Teaching setting:** Teach in a line direction or rotation direction. Refer to the figures below for details.
- **Teaching Point:** Set two points and calculate the direction and distance. The two points are not the actual recorded points, and the movement method is relative movement similar to the Move node.
- **Range Adjustment:** Provide Users with direct adjustment of distance or angle in the original direction without resetting the teaching point.

Linear

Only Linear difference between the 2 teach points is used to perform a relative compliance motion from the point entering the node

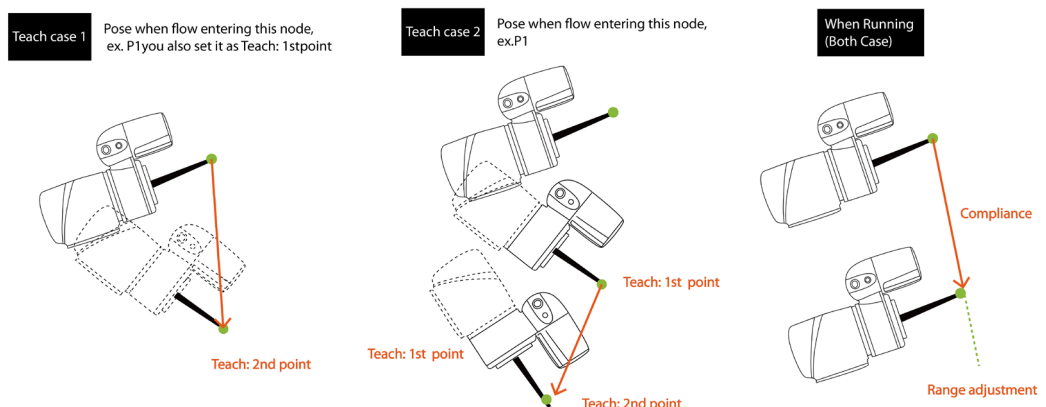

Figure 204: Line Direction

Rotation

Only orientation difference between the 2 teach points is used to perform a relative compliance motion from the point entering the node

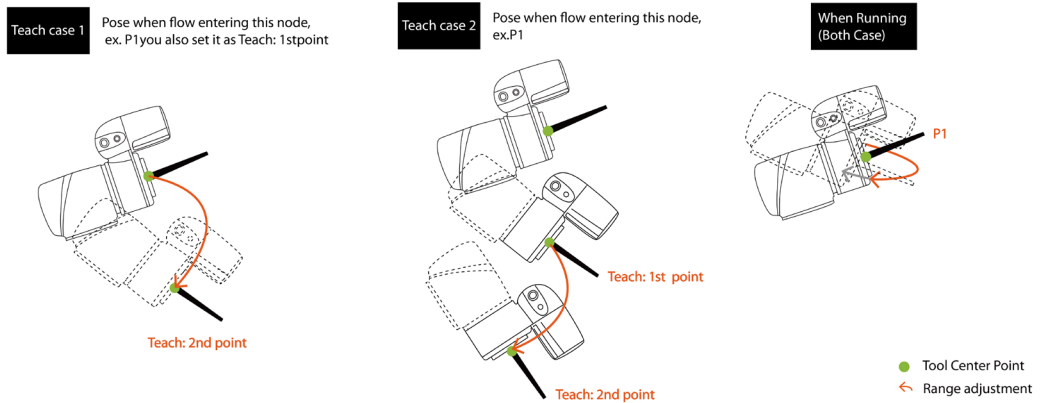

Figure 205: Rotation Direction

Users can pre-program the solution for any possible situation according to the result of **Variable** returned by the **Compliance** node, and coordinated with the **IF** node.

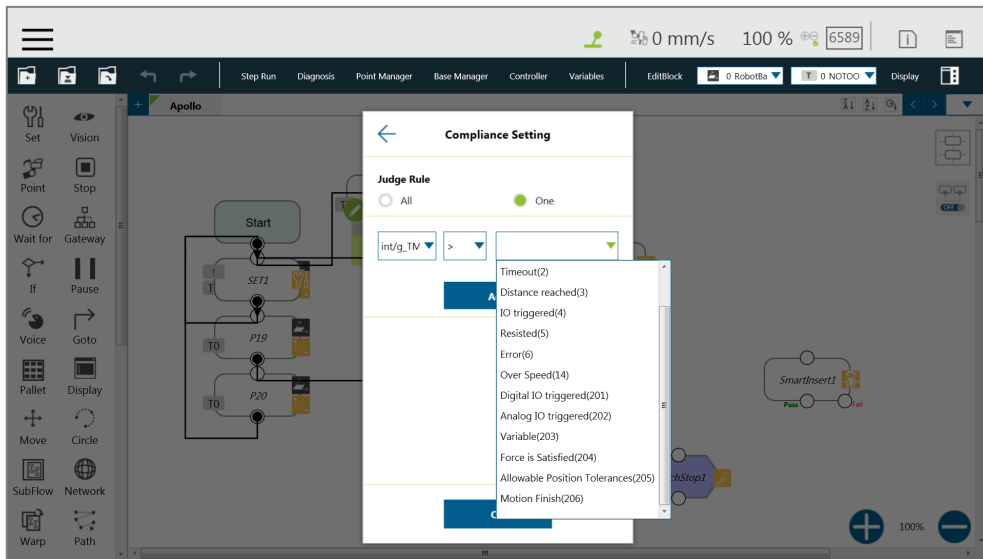
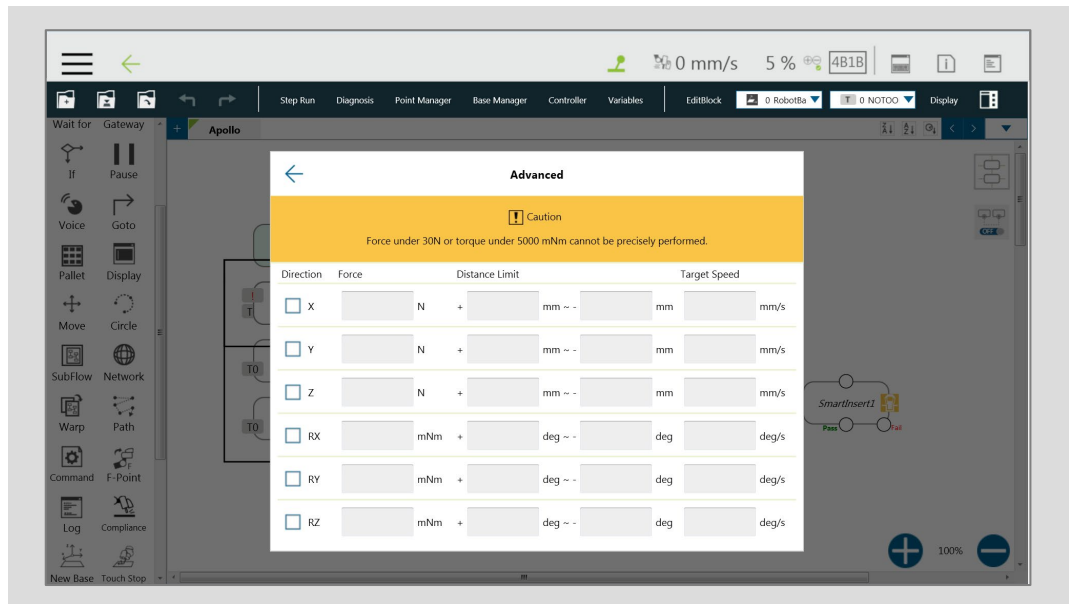

Figure 206: Compliance Variable Selection

Note

NOTE:

Users can use **Advanced In Compliance Setting** as a way to edit the force and the torque on each axis in compliance motions without force sensor and to function more practically to setup the application strategy. Users can choose axes as rigid or compliant and decide the target force. **Advanced** is useful for applications with high force/torque tolerances. The minimum force is 30 N, and the minimum torque is 5000 mNm.



14.2 F/T Sensor

TM Robot integrates F/T sensors from a variety of brands into **TMflow** for users to configure and utilize instantly. Users can click the icon of **F/T sensor** at the right of the **Project Editing Page** to select and configure F/T sensors as shown below.

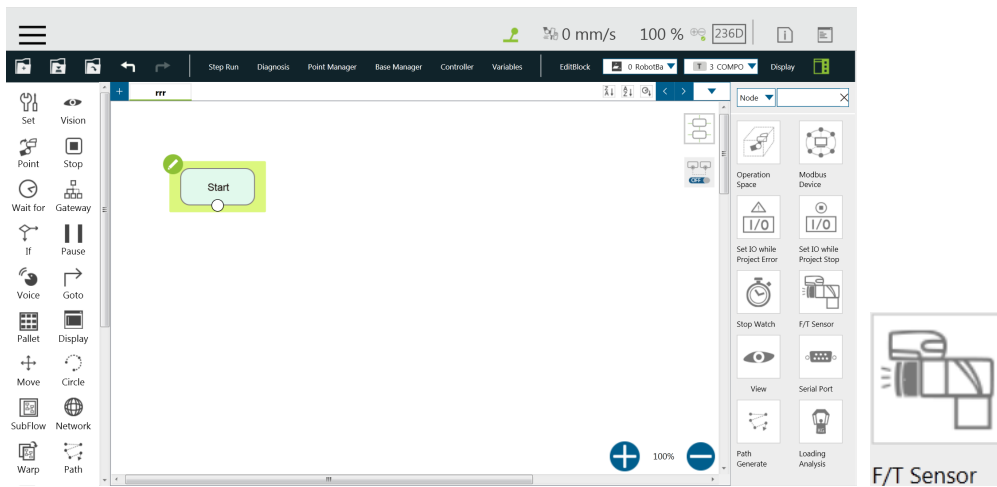

Figure 207: F/T Sensor

After configuring the **F/T Sensor** communication and position settings, users can use the configured F/T sensor.

14.2.1 Communication Setting

Users can configure the model numbers and the communication ports of the TM Robot supported F/T sensors in the communication setting of F/T Sensor.

To configure the communication setting, follow the steps.

1. Click the icon of **F/T sensor**, and click **Add Device**.
2. Select **Communication Setting**.
3. Fill a desired name in the field of **Device Name**.
4. Select **Vendor/Model** and **Com port** of the F/T sensor in the respective dropdowns.
5. Click **OK** when done.

Note

NOTE:

Users can fill self-defined names in field of Device Name, select **vendor/Model** of the installed F/T sensor as well as **Com port** that the installed F/T sensor plugged in, and click **OK** to complete the setting. **Baud Rate**, **Data Bit**, **Stop Bit**, and **Parity** are for confirmations only and not configurable by users.

Once the setting is done, users are able to view the configured F/T sensor and values of axes on each direction sensed by the F/T sensor listed in **F/T sensor** as shown.

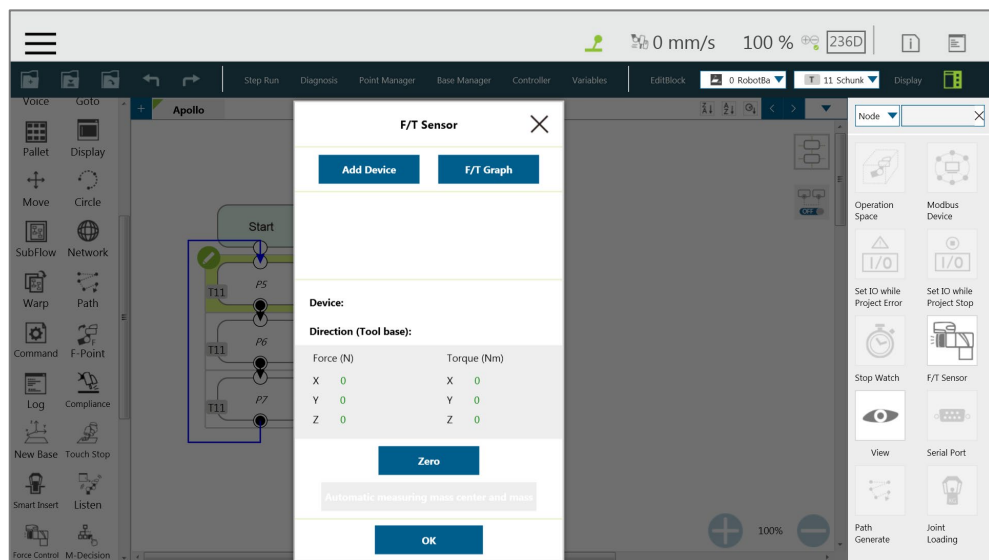

Figure 208: Read Values after Setting F/T Sensor

Note

NOTE:

Click **Automatic measuring mass center and mass** will generate values in **Tool Gravity Compensation Setting**.

14.2.2 Position Setting

Users can define the position of the F/T sensor to the TM Robot flange in **Position Setting** to convert the coordinates that the F/T sensor measured to the coordinates of the robot flange. The calculation method of the F/T sensor position is as shown in the figure below. Users have to measure the values of X, Y, and Z of the F/T sensor to the TM Robot flange and confirm the

rotation angle RX, RY, and RZ based on the angle the F/T sensor installed onto the TM Robot flange.

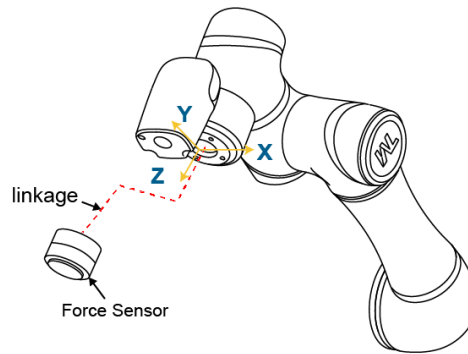

Figure 209: Position Setting

After confirming the positions and the angles the F/T sensor installed onto the TM Robot flange, users can fill the values of the positions and the angles in **Position Setting** as shown below.

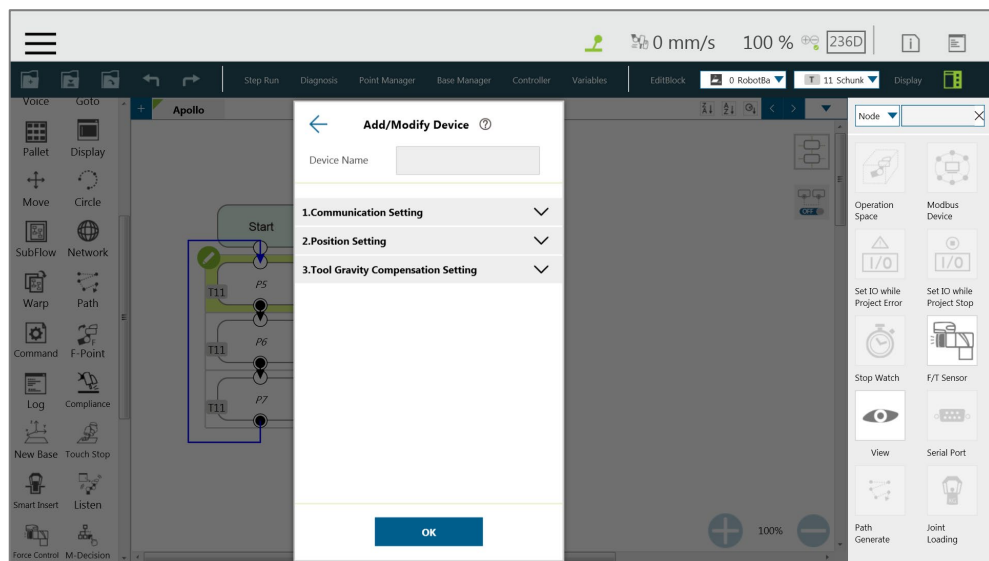

Figure 210: Select Position Setting

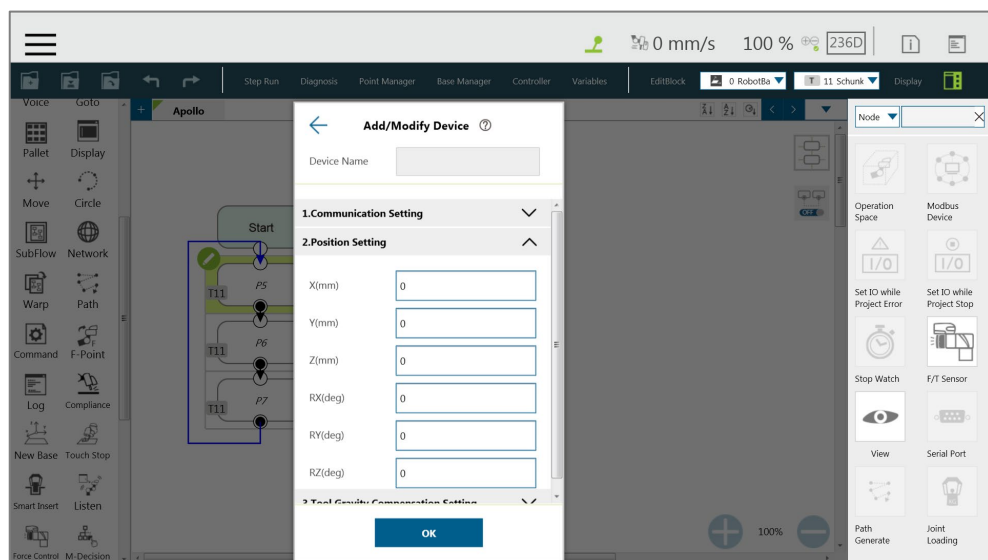

Figure 211: Input Values

14.2.3 Import/Export Settings of F/T Sensor

TMflow supports import/export settings of F/T Sensor. Users can export the configured F/T sensor settings and import to the other TM Robots. All users have to do is to export the projects with F/T sensor settings configured and the settings relative to the F/T sensor will be exported along. Refer to 5.8.6 Import/Export for details

14.2.4 Force Value and Charts

Once the settings of the F/T sensor are configured, users can observe lines of forces and torques of the F/T sensor in the charts as shown below. Users can also view the fluctuations of forces and torques in the running task while editing in **TMflow**. To show the charts, click the **F/T Graph** button. Click the dropdown next to **Choose Device** for the values read from the sensor or the calculated by the node with the axis and the direction. Check the box before the force or the torque to show the graph on the charts. Check **Auto Scaling** to have the system scale the detected values automatically or set the maximum and the minimum manually.

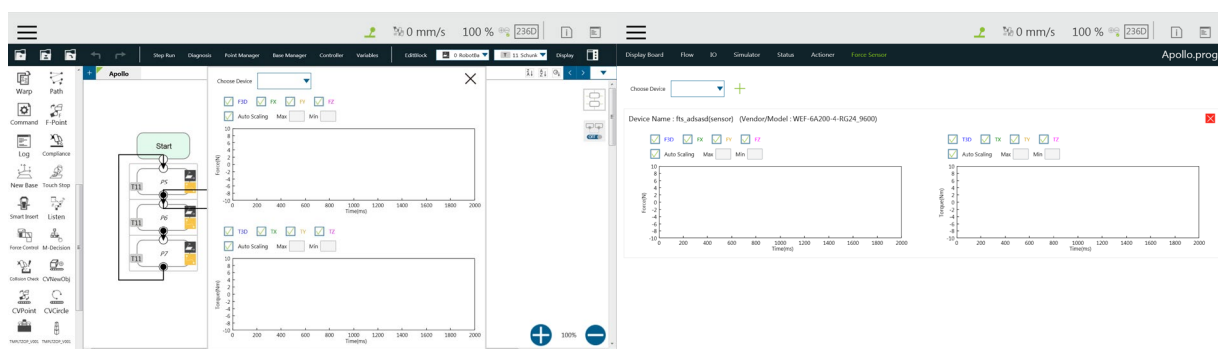

Figure 212: Charts

The line charts can float on the **Project Page** and show in the **Display Board**.

Note

NOTE:

F3D and T3D represent resultant force and resultant torque respectively, namely that

$$F3D = \sqrt{F_x^2 + F_y^2 + F_z^2} \quad T3D = \sqrt{T_x^2 + T_y^2 + T_z^2}$$

14.3 Touch Stop Node

The **Touch Stop** node comes with three function types: **Compliance**, **Line**, and **Force Sensor**.

14.3.1 Function Type: Compliance

Capable of setting the force limit when the robot moves along a single **Base**, this setting can be used for various applications of object searching, creating a new **Base**, and recording the current coordinate value of triggering **Touch Stop**.

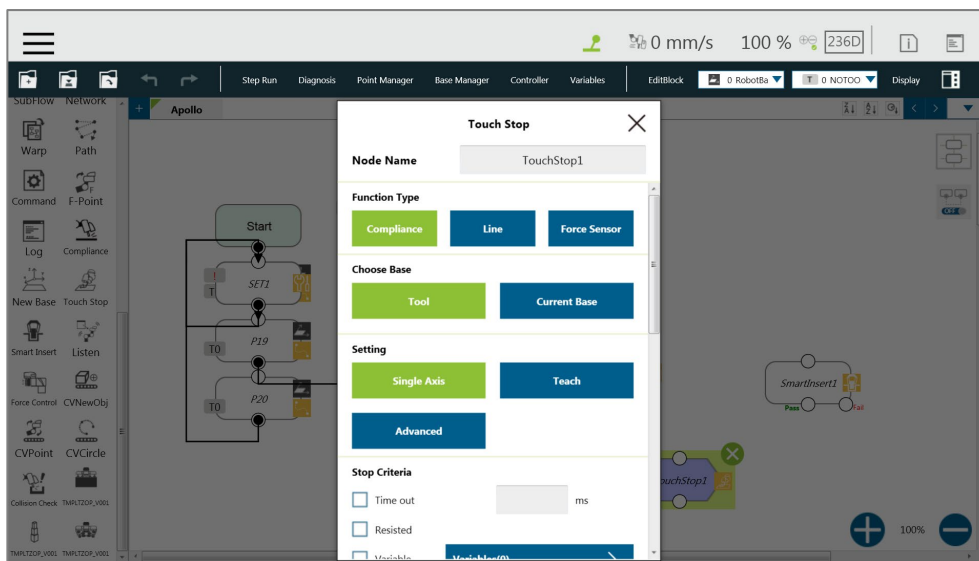

Figure 213: Touch Stop-Compliance Settings

- **Choose Base:** Select **Tool** or **Current Base**, and click **OK** to have the robot move accordingly.
- **Setting:** Select **Single Axis** to define the direction (axis), distance, target force/Torque, speed of the compliance, **Teach** to use manual teaching method, or **Advanced** to define force/torque, distance limit, and target speed for applicable directions of compliance.
- **Stop Criteria:**
 - **Timeout:** Set the length of time to stop and release this node
 - **Resisted:** When the resistance is sensed, the speed at the robot end is close to zero,

and the node is released

- **Variable:** Set rules to determine variables
- **Digital Input:** Set a digital input signal to release this node once a specific DI is triggered
- **Stroke % for DI Detection:** Applicable to **Single Axis** and **Teach**. Detects DI along the moving distance in the single axis. Stops and outputs the variable with Error (6) if DI is detected below the stroke percentage. Stops and outputs the variable with IO Triggered (4) if DI is detected above the stroke percentage.
- **Analog Input:** Set an analog input signal that, when met, the node is released.
- Others:
 - **Output Variable:** Set Stroke % for DIO Detection Receiving Variable
 - **Change payload to:** If equipped, set the weight of the device at the end of the robot in kilogram.
 - **Compliance Duration when Stop:** Set the length of time to switch between force control and position control. Defaults to 200 milliseconds, the value is valid between 0 and 1000 milliseconds as an integer and supports the variable setting.
 - **Resistance on non-target motion direction:** Reduce the vibration of the robot. Set to **High Resistance** for applications with great reactions against the robot TCP.
- **Record Stopping Position on POINT:** Select from the **Stopping position** or the **Triggered position** and fill the name in the field below to record the robot position at the time being as a dynamic point when the robot puts on the brake. The dynamic point will be in **Point Manager** when you have:
 - ◆ clicked **Test**
 - ◆ clicked **OK** or **run/Step Run** the flow
- **Test:** Test the performance. The robot will actually start moving at 3% of project speed when this button is pressed.

Note

NOTE:

On all stop criteria, the **Touch Stop** points recorded to Modbus devices. Refer to Table 30: Modbus – Robot Coordinate (When Touch Stop node is triggered) and Table 44: Modbus – Safety Stop Criteria for the Modbus addresses.

14.3.2 Function Type: Line

This function is designed to set the robot's line movement along a **Single Axis**, or direction **Teach**, and works with the external signals to stop the robot motion. This setting can be used for sensors on external tools to record the position. Users can determine the direction of robot motion based on the **Tool** or the **base**.

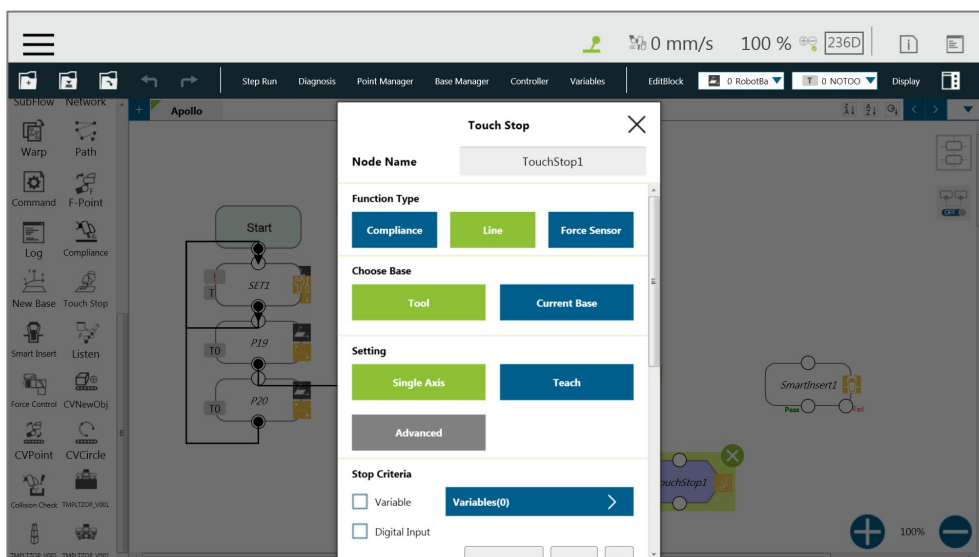

Figure 214: Touch Stop-Line Settings

- **Choose Base:** Select **Tool** or **Current Base**, and click **OK** to have the robot move accordingly
- **Setting:** Set the robot to move along the direction of a single axis or teach using manual teaching. Check the box next to **Link to project speed** to align the speed with the project speed.
- **Stop Criteria:**
 - **Variable:** Set rules to judge from the outcomes of variables in expressions
 - **Digital Input:** Set a digital Input signal to release this node once a specific DI is triggered
 - **Analog Input:** Set an analog input signal that, when met, the node is released.
- Others:
 - **Braking distance:** Set the distance available from 0 to 5 mm for the robot putting the brake on digital input or analog input. The maximum distance available is 5 mm. An input value larger than 5 will give an error message.
 - **Change payload to:** If equipped, set the weight of the device at the end of the robot in kilograms.
- **Record Stopping Position on POINT:** Select from the **Stopping position** or the **Triggered position** and enter the name in the field below to record the robot position, as a dynamic point, at the time when the robot puts on the brake. The dynamic point will be in **Point Manager** when you have:
 - ◆ clicked **Test**
 - ◆ clicked **OK** and **Run/Step Run** the flow
 - **Test:** Test the performance. The robot will actually start moving at 3% of project speed

when this button is pressed.

14.3.3 Touch Stop Function Type: Force Sensor

Of the three function types in a **Touch Stop** node, **Force Sensor** is the only one that uses the force sensor to proceed with the force touch stop measurement. Once configured, users can select **Force Sensor** to assign the desired device as shown below, and use the device to measure the sensed force along the named directions.

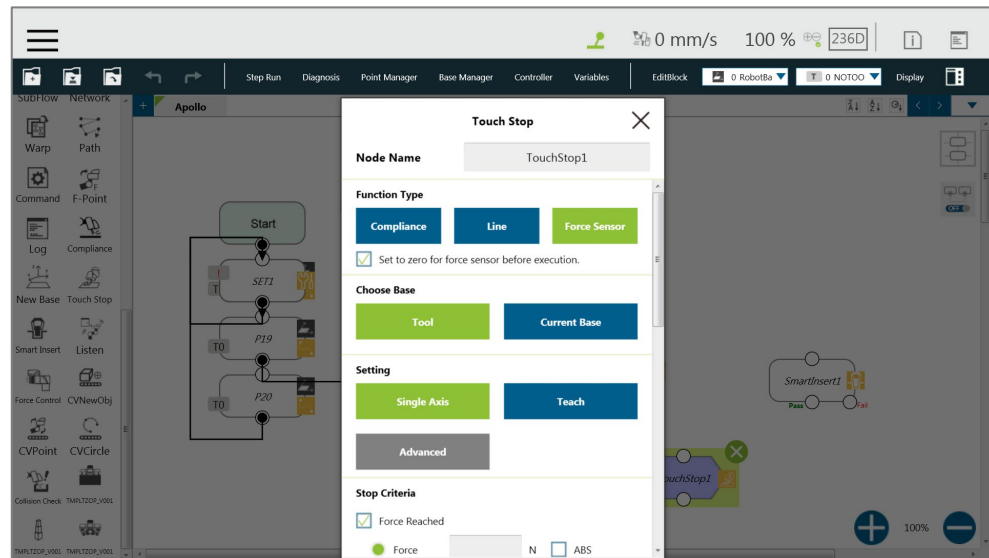

Figure 215: Force Sensor

To select a configured force sensor, follow these steps.

1. Click the pencil icon of the **Touch Stop** node.
 2. Click the **Force sensor** button in **Function Type**.
 3. Click the box next to **Choose device** to select from the list of the configured force sensors.
 4. Click **OK** when done.
- **Set to Zero for Force Sensor before Execution:** For more precise measured values while running force tasks, users can check this feature prior to running force tasks. This feature sets zero to every current axis value of the force sensor, so the returned force values reflect the actual force in the force tasks.
 - **Choose Base:** Select **Tool** or **Current Base**, and click **OK** to have the robot move accordingly.
 - **Setting:** Set the robot to move along the direction of a single axis, teach using manual teaching.
 - **Stop Criteria:**

- **Force Reached:** There are three type of force reached to choose: **Force**, **F3D**, and **T3D** as shown below.

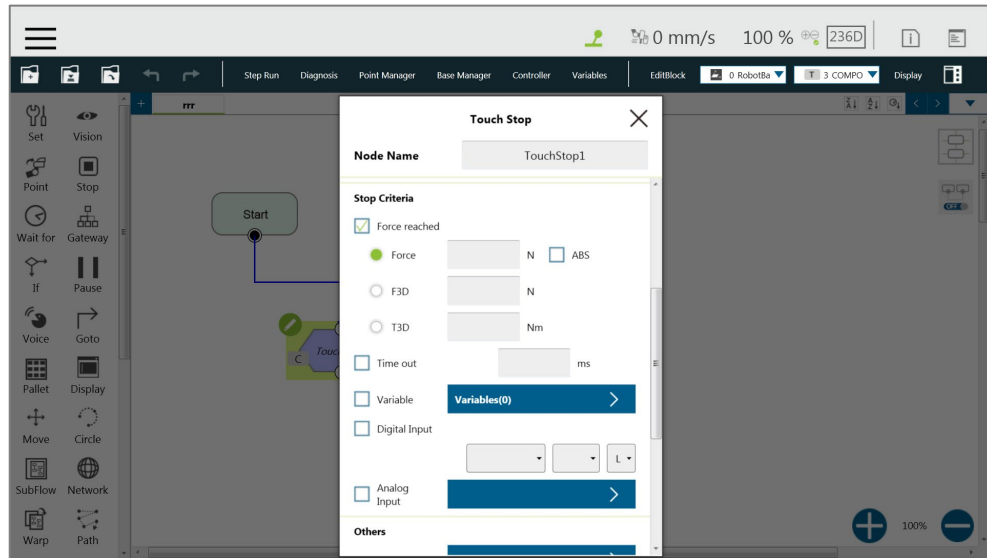

Figure 216: Force Sensor

Note

NOTE:

Force will change the measurement unit based on users' setting in Single Axis. In other words, if users set **Direction** to Rx, Ry, or Rz, the measurement unit will change from N to Nm. Force/Torque monitors the forces/torques along the named directions. Once it reaches the preset values of the forces/torques, the robot stops the detection movement to proceed with the next assigned movement, namely that forces/torques along the other directions but not the named directions will not fulfill the stop criteria of the **Touch Stop** node while the project is in progress.

- **Timeout:** Set the length of time to stop and release this node
- **Variable:** Set rules to judge from the outcomes of variables in expressions
- **Digital Input:** Set a digital Input signal to release this node once a specific DI is triggered
- **Analog Input:** Set an analog input signal that, when met, the node is released.
- **Others:**
 - **Output Variable:** Set Stroke % for DIO Detection Receiving Variable
 - **Change payload to:** If equipped, set the weight of the device at the end of the robot in kilograms.

Note

NOTE:

Force and torque will be obtained when the tool of the robot collides with environment. The reaction force/torque will also operate at robot. If the robot switches to position control, the robot might generate a safety alarm due to reaction force/torque. In order to

avoid the error safety alarm, the **Touch Stop** node will turn control mode to **Compliance** when force/torque reaches users' stop criteria. Users can set payload which is the weight from the robot flange to the end of the tool for having better **Compliance** operation.

- **Compliance Duration when Stop:** Set the length of the time to switch between force control and position control. Defaults to 200 milliseconds, the value is valid between 0 and 1000 milliseconds as an integer and supports the variable setting.
- **Record Stopping Position on POINT:** Select from the **Stopping position** or the **Triggered position** and enter the name in the field below to record the robot position, as a dynamic point, at the time when the robot puts on the brake. The dynamic point will be in **Point Manager** when you have:
 - ◆ clicked **Test**
 - ◆ clicked **OK** and **Run/Step Run** the flow
- **Test:** Test the performance. The robot will actually start moving at 3% of project speed when this button is pressed.

Note

NOTE:

The system will report an error and light in red if no device is in the node setting.

14.4 Smart Insert Node

The **Smart Insert** Node allows the robot to perform assembly/pushing jobs. The smart design enables difficult object assembly/pushing jobs to be completed through simple and quick setting. The inserting action of **Smart Insert** Node can be divided into three steps: **Approaching**, **Searching**, and **Pushing**. This Node needs to be worked with the cooperating force sensor in TM Plug&Play for use. The following describes the three steps of pushing.

14.4.1 Approaching

14.4.1.1 Approaching principle description

Before using the **Smart Insert** node, users should place the inserting object as close to the assembly as possible. In the **Approaching** step, the robot will move in the z axis direction of the **Tool Coordinate** until the force sensor detects 5 Newtons (N).

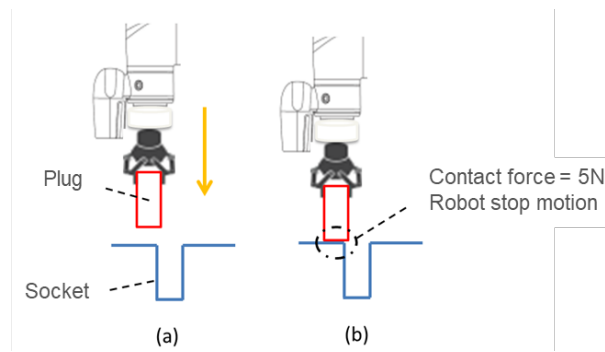

Figure 217: Approaching Principle

- (a) Try to position the robot as close to the socket as possible
- (b) When the contact force is 5 Newtons, the robot ends **Approaching**



IMPORTANT:

Since the contact force needs to reach 5 Newtons, for the **Approaching** step to end, users need to confirm that the socket and object to be inserted are able to withstand at least 5 Newtons of force, so as not to damage the product.

14.4.1.2 Approaching parameters setting

The **Approaching** of the **Smart Insert** Node provides three setting parameters:

- **Approaching Speed**
0.5 to 10 mm/s
- **Moving Distance Limit**
1 to 100 mm
- **Time Out**
1 to 20 s

Note that the approaching direction of the **Smart Insert Node** is the Z axis direction of the Tool Coordinate.

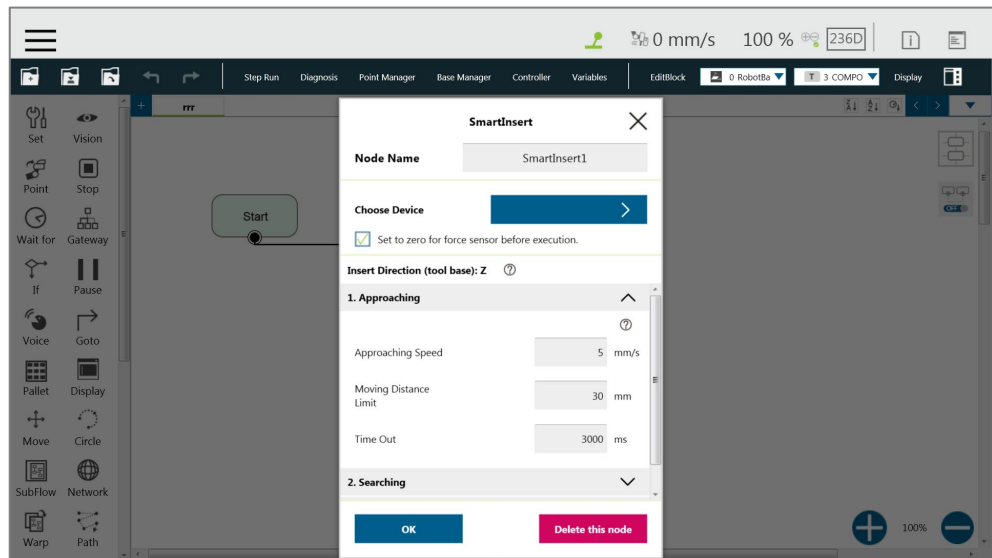

Figure 218: Approaching Parameter Setting

14.4.2 Searching

After ending **Approaching**, the robot switches to **Searching**. **Searching** can be divided into two strategies: **Spiral** and **Linear**. The figure below is the motion method of the **Spiral** strategy. This searching strategy uses the **Approaching** contact point as the center of the spiral, and searches outward in a spiral motion until the stop condition is met. If users select **Linear** for searching, the robot will follow the selected axis to perform **Line** search until the stop condition is met, as shown in the figure. Regardless of **Spiral** or **Linear**, the robot exerts the **Contact Force** as a constant downward force in the Tool Z-axis direction during searching.

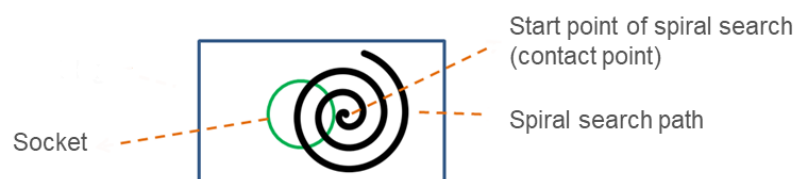

Figure 219: Spiral Searching Method

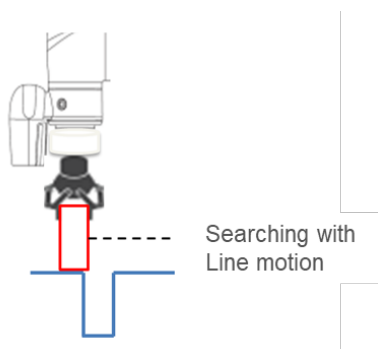

Figure 220: Line Searching Method (1/2)

The stop criteria of **Searching** comes with **Completed Searching** and **Stop Searching**. If the plug enters the socket, the combined force of X-Y Plane will be greater than 5 Newtons (N), and the contact force on the z-axis equals 0. This is judged as **Completed Searching** and goes to the final stage of **Inserting**. **Stop Searching** is determined by the robot being unable to find the socket within the search conditions, such as the searching time or distance being too long.

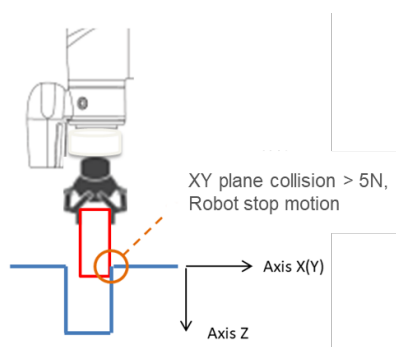

Figure 221: Line Searching Method (2/2)

When the XY combined force of collision is greater than 5 Newtons, it is judged as **Completed Searching**.

14.4.2.1 Method for searching: Spiral

In **Spiral** searching, the **Searching Radius**, **Circling Frequency or Tangential Speed**, **Height Tolerance**, and **Time Out** need to be set. These parameters are shown in the Table below.

Terminology	Definition	Setting Range
Contact Force	Tool Coordinate Z-axis contact force	5~10N
Searching Radius	Maximum radius of spiral searching motion	1~30mm

Circling	Frequency	Number of circles per second	0.5~1.5Hz
	Tangential Speed	Speed of circling per second	1~90mm/s
Height Tolerance		Maximum height of the robot in Tool Coordinate Z axis	1~100mm
Timeout		Maximum searching time	1000~20000 ms

Table 15: Spiral Searching Function Setting Parameters Definition

Note that during the spiral searching process, the robot may move out of the boundary of the socket, and misjudge it as **Inserting Point Found**. Setting a **Height Tolerance** can prevent this from occurring.

Note

NOTE:
In general, if the geometry shape of the inserting object is circular, such as positioning pins, it is recommended to use the spiral searching method; if the geometry shape of the insert object is rectangular, it is recommended to set the searching method to **Linear**.

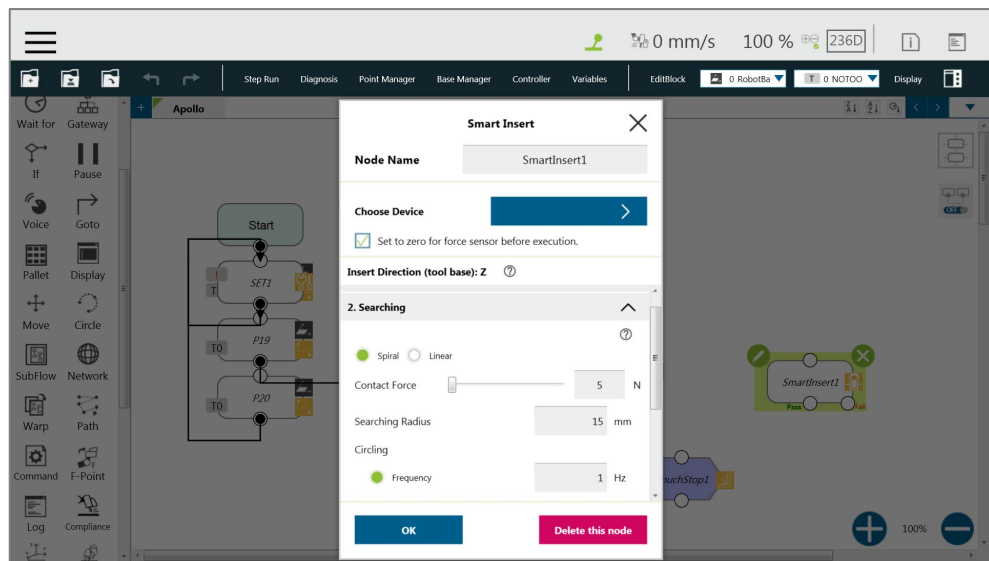

Figure 222: Spiral Searching Parameter Setting Interface

14.4.2.2 Method for searching: Linear

Different from the **Spiral** searching, the **Linear** searching can set the power of the Tool Coordinate Z axis contact force and the **Linear** searching direction (**Searching Direction**). The **Linear** searching parameters are defined as shown in the Table below.

Terminology	Definition	Setting Range
Contact Force	Tool Coordinate Z-axis contact force	5~10N

Searching Direction	Select Tool Coordinate X, Y, -X, or -Y axis search direction	-----
Searching Speed	Speed of linear searching	0.5~10mm/s
Maximum searching distance	Maximum distance to search	1~100mm
Timeout	Maximum Searching Time	1000~20000 ms

Table 16: Linear Searching Function Setting Parameter Definition

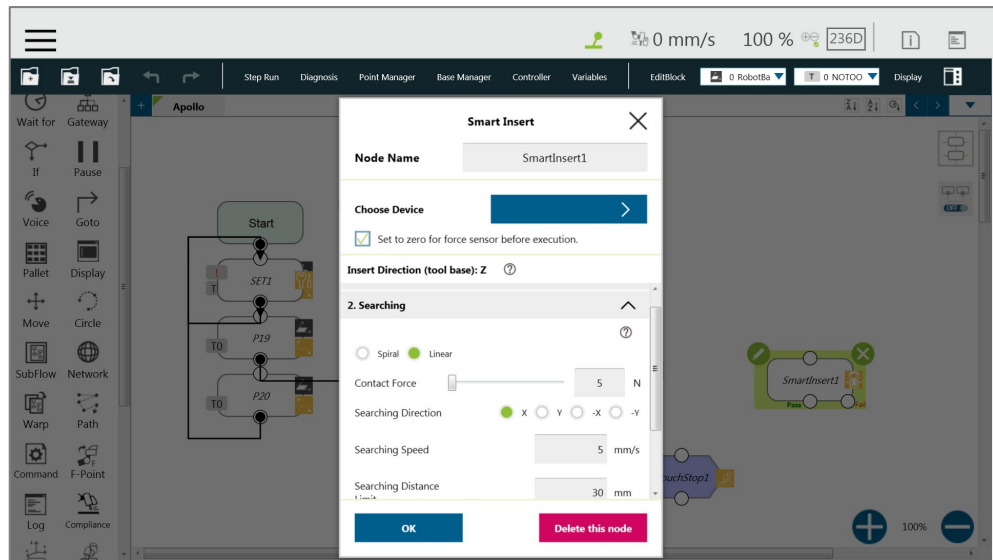

Figure 223: Linear Searching Parameter Setting Interface

14.4.3 Pushing

After completing steps in **Searching**, the plug has been aligned with the socket. During **Pushing**, the robot will move in the Z-axis direction until the stop condition is reached, such as detecting the Z-axis contact force or the stroke distance. If X, Y, RX, RY, and RZ detect external force resistance, the **Smart Insert** node will automatically move smoothly in the opposite direction of the collision to avoid causing interference during pushing.

14.4.3.1 Parameter Setting

Parameter setting of **Pushing** is similar to the **Linear Searching**. Users can set the **Contact Force**, **Pushing Speed**, **Moving Distance Limit** and **Time Out** of the **Pushing** process. The definition and setting of each parameter is shown in the Table below.

Terminology	Definition	Setting Range
Contact Force	Tool Coordinate Z-axis contact force	5-150N
Pushing Speed	Moving speed of linear pushing	0.5-10mm/s

Moving distance Limit	Maximum moving distance	1-100mm
Timeout	Maximum searching time	1-20sec

Table 17: Pushing Parameter Definitions

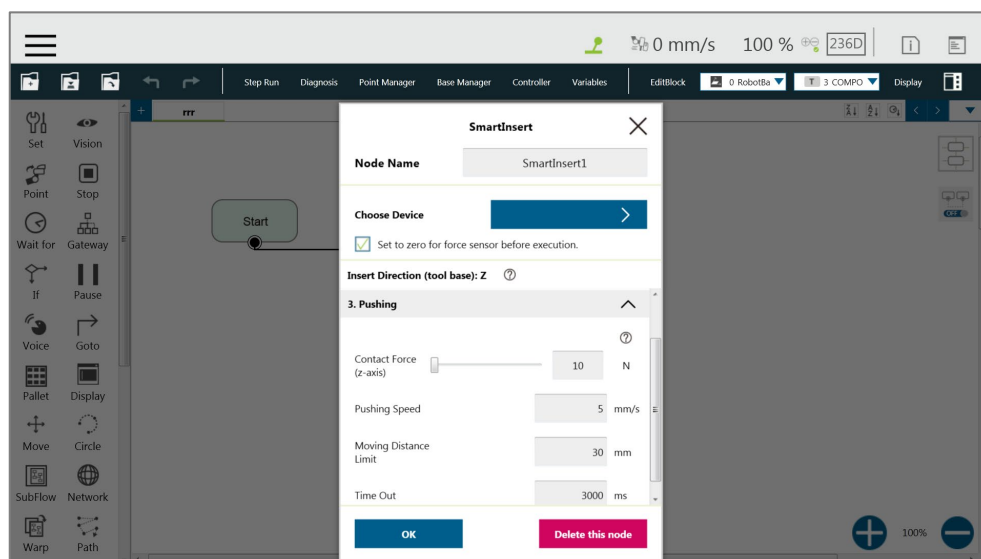

Figure 224: Pushing Parameter Interface



NOTE:

The system will report an error and light in red if no device is in the node setting.

14.5 Force Control Node

The **Force Control** node comes with three reference coordinates and two operation modes for applications such as polishing, grinding, and deburring.

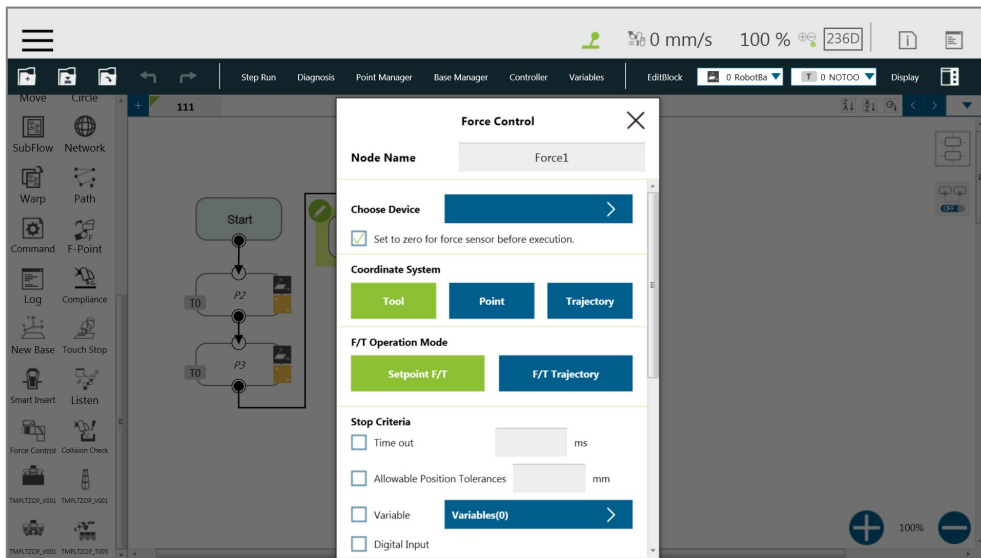

Figure 225: Force Control Node Settings

- **Choose device:** Select a configured force sensor from the list
 - **Set to zero for force sensor before execution:**
This function will zero the value of each axis of the current force gauge. Therefore, when entering the task force, the obtained force values can reflect the real physical forces that occur.
- **Coordinate Systems**
Define F/T sensor in one of the three coordinate systems.
 - **Tool:** Couple the coordinates of the force sensor and the coordinates of **TCP** directionally.

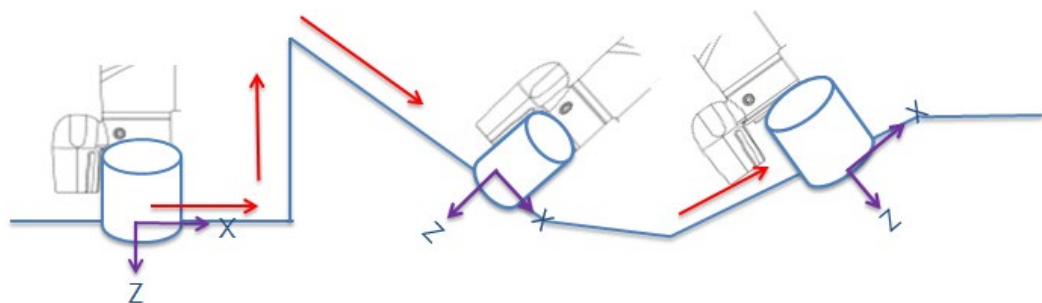

Figure 226: Tool Coordinate System

- **Base:** Record the current **TCP** pose and apply measured force built with this base. The pose can record on another **Base**.

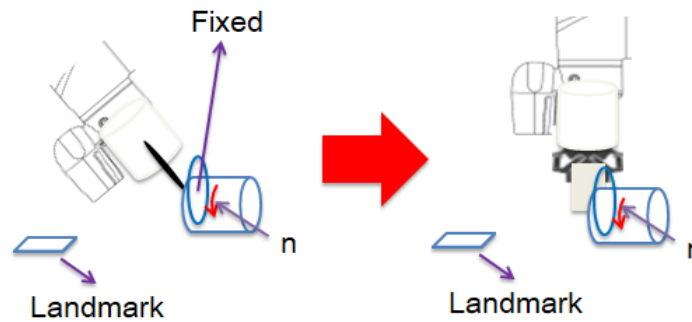
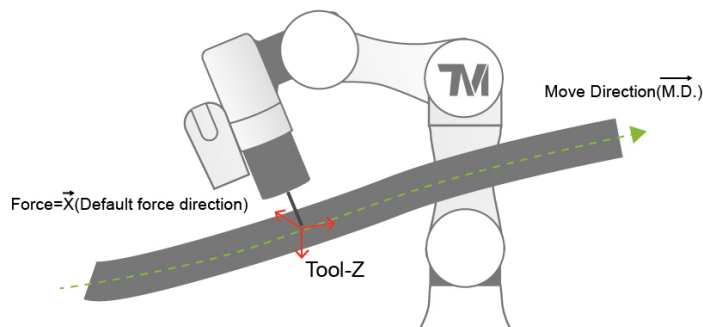

Figure 227: Base Coordinate System

In base system, users only need to move the robot into the measuring pose, record the point of the pose, and select the point in **Import from existing points** to define the force sensor coordinate system with the select point.

- **Trajectory:** The coordinate of FT sensor changes along with the path (speed tangent direction).



$$\begin{aligned} \vec{X} &:= \overline{M.D.} \times \overline{Tool(Z)} \quad (\text{Tool}(z) \text{ can't be parallel with } \overline{M.D.}) \\ \vec{Z} &:= \vec{X} \times \overline{M.D.} \\ \vec{Y} &:= \overline{M.D.} \end{aligned}$$

Figure 228: Trajectory Coordinate System

Note

NOTE:

1. The direction of the trajectory movement cannot be parallel to the **TCP** of Tool Z.
2. When the **TCP** of the robot does not have the XYZ direction speed at two consecutive machining points as shown in the figure below, the force sensor coordinate system may be incorrectly operated and resulting in unexpected results. It is recommended to change the machining path or select **Tool** or **Base** as the reference coordinate system.

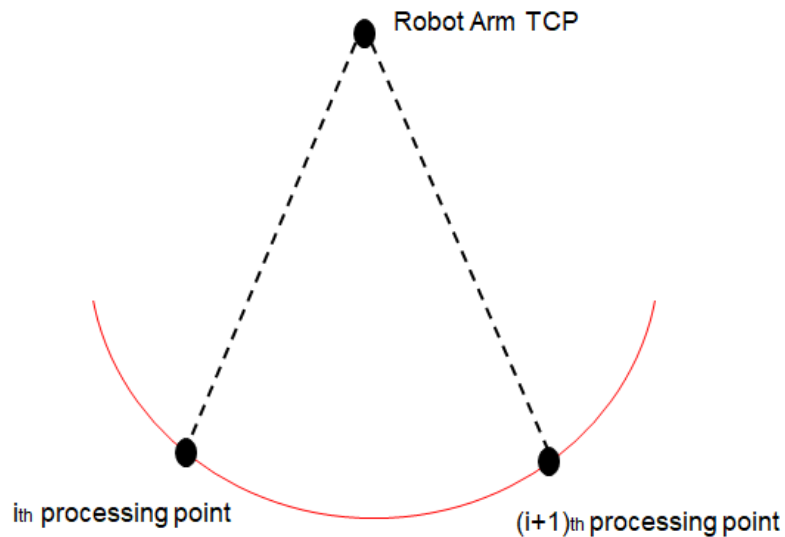

Figure 229: Possible Conversion Error

The two consecutive processing points on the TCP position of the robot, if in fixed-point motion, may cause the force sensor coordinate system conversion error.

- **F/T Operation Modes**

Select from two of the F/T operation modes.

- **Setpoint:** Use Setpoint to set the XYZ axial force and the Rx, Ry, and RZ axial moments as required as shown in the figure below. The positive and negative values set represent the direction of force control. Users can click the **Var** button to select a variable as a value to apply. In the axial PID values of the force control, the parameters of the five sets of PIDs are provided from weak to strong. Users can click the **Advanced** button to set the PID values according to each axial force control and click the **Var** button to select a variable as a value to apply. In order to avoid the robot movement control speed being too fast after adjusting the PID parameters, users can set the maximum speed value of the robot movement in the speed limit. If the robot exceeds the speed limit, the robot will immediately stop and report the error.

To have the robot perform force control in a known safe space, users can set the range of the robot movement. The system will move the robot in a cube with the length in accordance with the set value. The available range is 0~4000mm.

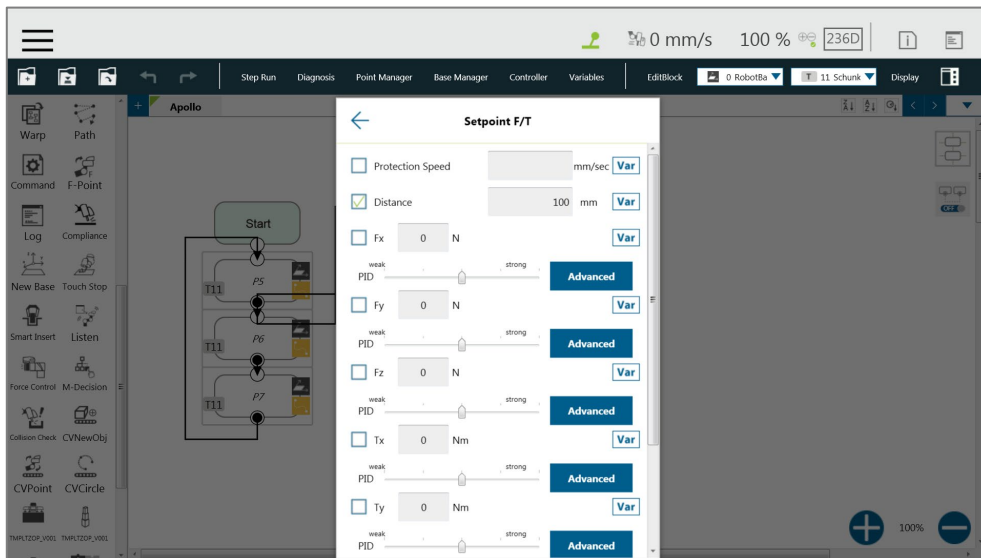

Figure 230: F/T Operation Modes – Setpoint

Note

NOTE:

Users can adjust PID values for specific applications. However, self-adjusting the PID parameters may cause the robot to control the divergence and cause vibrations or errors. For the Kd (Derivative gain) value, the suggested initial value of adjustment is 0.001. During the adjustment, a joint error may occur for generating large deviation in the control command sent to the joint (e.g. error code 0x0005FFCB). To recover from the error, press and release the **Emergency Switch** of the **Robot Stick** to safely start up again.

- Trajectory:** When the robot task needs to follow a specific machining path and maintain the force control while moving along the path, the operation mode **Trajectory** can be selected. The force/torque, PID settings, and speed limits for each axis are the same as **Setpoint**. To import the movement path of the force control, users can add or select **Subflow** in the **Choose F/T Subflow** option as shown below.

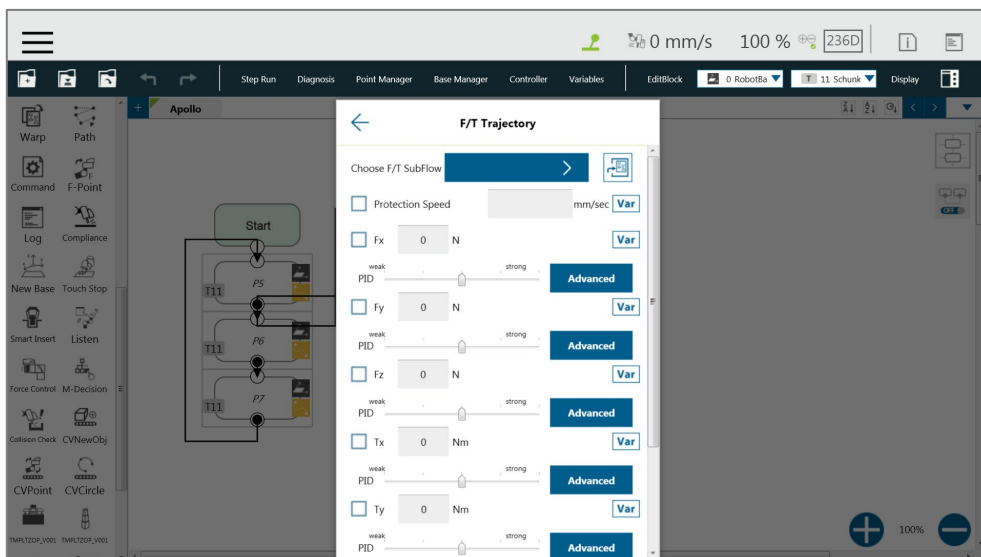

Figure 231: F/T Operation Modes – Trajectory (1/3)

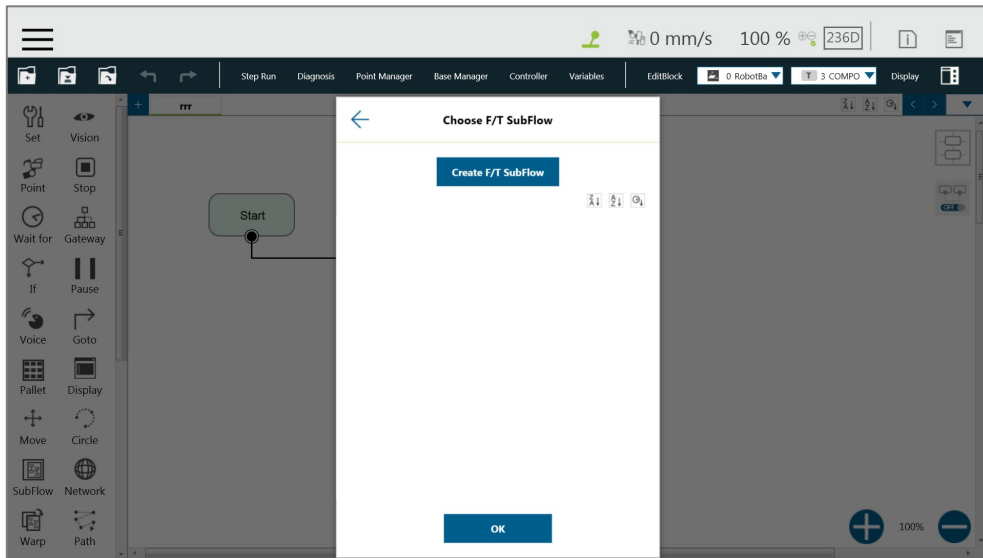

Figure 232: F/T Operation Modes – Trajectory (2/3)

In the **F/T Subflow** of the **Trajectory**, the **TCP** of the path needs to be consistent with the **TCP** of the previous position of the **Force Control** node as shown in the figure below; otherwise the robot will stop immediately and report an error that the difference is too big. Users can click the **Var** button to select a variable as a value to apply.

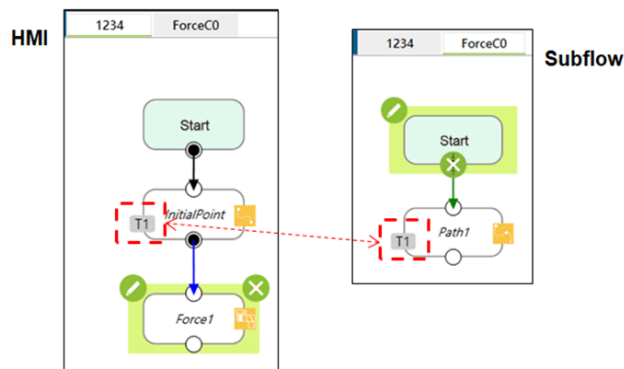

Figure 233: F/T Operation Modes – Trajectory (3/3)

■ **Stop Criteria:**

- **Timeout:** Set the length of time to stop and release this node. Click the **Var** button to select a variable as a value to apply.
- **Allowable Position Tolerances:** When the robot follows the machining path for force control, because the position of the workpiece is not the same as the path planning, it may cause the robot to move in the direction of force control resulting in machining

errors. Users can set the allowable machining error. If the actual machining path is different from the planned path and exceeds the allowable machining error, the robot will release the Force Control node. Click the **Var** button to select a variable as a value to apply.

- **Variable:** Set rules to judge from the outcomes of variables in expressions
- **Digital Input:** Set a digital Input signal to release this node once a specific DI is triggered
- **Analog Input:** Set an analog input signal that, when met, the node is released.
- **F/T Reached:** Set the values of the force or the torque on the custom axes as the criteria to detect. Check the box before **Use Absolute Values** to use absolute values only. Other than **F3D** and **T3D**, users can set negative values for the opposite direction of the force or the torque.

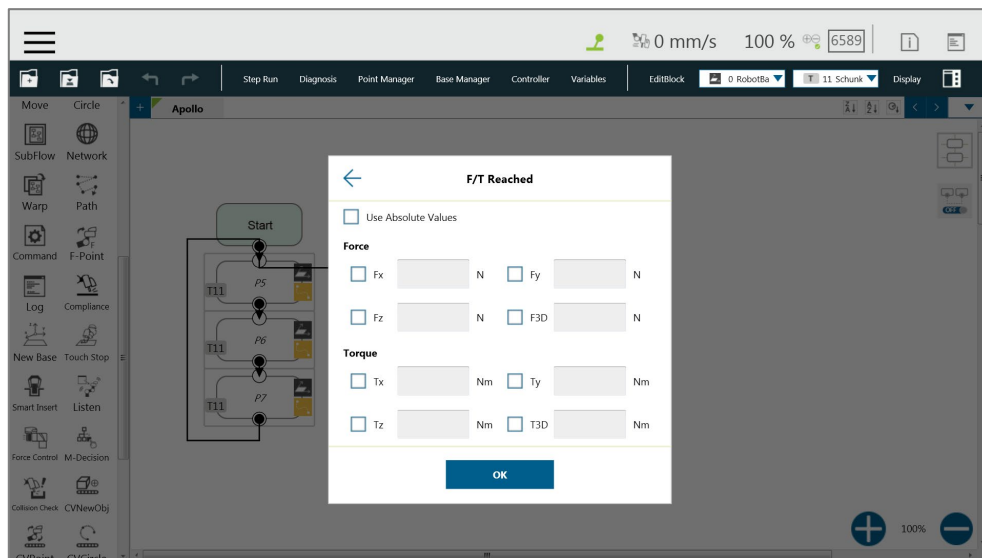

Figure 234: Stop Criteria – F/T Reached

- **Others:**
 - **Output Variable:** Set Stroke % for DIO Detection Receiving Variable
 - **Change payload to:** If equipped, set the weight of the device at the end of the robot in kilograms. Click the **Var** button to select a variable as a value to apply.
 - **Compliance Duration when Stop:** Set the length of the time between force control and position control. Defaults to 200 milliseconds, the value is valid between 0 and 1000 milliseconds as an integer and supports the variable setting. Click the **Var** button to select a variable as a value to apply.
- **Test:** Test the performance. The robot will actually start moving at 3% of project speed when

this button is pressed.



NOTE:

The system will report an error and light in red if no device is in the node setting.

15. Operation Space

15.1 Overview

TMflow provides two spatial characteristics of plane and cube for operation space environment construction. When the robot crosses different operation spaces while running, the robot will switch between stop, **Reduced Mode**, and full speed mode. When calculating the position of the robot and its related actions in **Operation Spaces**, the **TCP** is used as the reference point. In other words, the position of the **TCP** decides the actions in **Operation Spaces** of the robot. When working in the **Reduced Mode**, all the safety settings, including TCP speed, TCP force, joint torque etc. follows the settings in **Human – Machine Safety Settings**. When working in the full speed mode, all the safety settings includes TCP speed, TCP force, joint torque and etc. follows the settings in **Performance Safety Settings**. However, pay attention that this function is not a safety function defined by TM Robot. This function is only suitable for dividing operation space, assisting users in understanding the spatial concept during teaching and programming, or letting the robot decelerate in advance to allow smoother deceleration before the robot moves through a safety sensor installed in the space.

Regarding switching and triggering of Human - Machine Safety Settings, use the User Connected External Safeguard Port for Human - Machine Safety Settings of this product. Add appropriate safety devices such as appropriate installation and configuration of safety sensors connected to the safety protection port with dual channel connections.



DANGER:

This function cannot be mistakenly used as a safety function. Users must conduct a comprehensive risk assessment according to the environment and conditions of use, and configure equipment such as a grating, laser scanner and others that comply with the safety regulations, and work with the safety protection port of this product from the external device to trigger the Human - Machine Safety Settings or pause. Set the operation environment correctly, or use other appropriate safety designs to prevent people from entering the robot's full speed space. This function is only to assist users in understanding the space concept more easily during the teaching and programming process. The Reduced Plane / Space function should only be used in the teaching process to know the Reduced Space and full-speed running area, instead of being mistakenly used for switching between the Human - Machine Safety Settings and full speed mode, and mistakenly viewed as a safety function. While using Stop Plane/Space during teaching, users should take this function as a way to avoid setting the point or the motion across the prohibited area but not as a safety function. The Corporation clearly specifies the following potential residual risks: There is a risk that causes the robot to hit human body at full speed due to improper use of safe space settings or running incorrect projects.

15.2 Operation Space Setting Page

Click **Operation Space** in the **Robot Setting** Page to access the **Operation Space** Setting Page. As shown in the figure below, the left side of this page provides space setting, the middle is the virtual robot interface, and the right side is the controller interface.

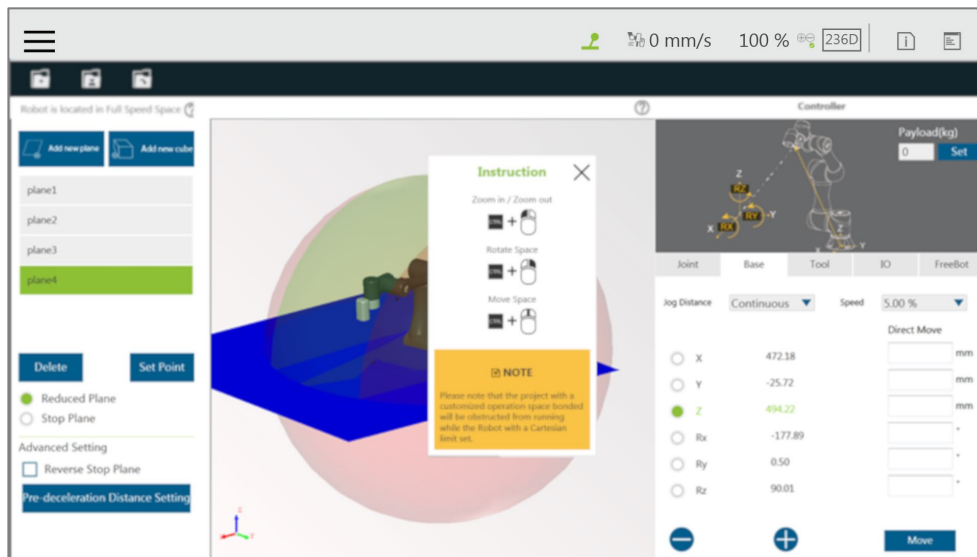

Figure 235: Operation Space Setting

Add new plane: Add plane

Add new cube: Add cube

Delete: Delete the selected characteristics

Set Point: Reset characteristics

Reduced Plane: Switch to reduced plane

Stop Plane: Switch to stop plane

Reverse Stop Plane: Check to reverse stop plane

Pre-deceleration Distance Setting: Pre-deceleration distance

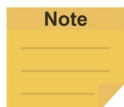

NOTE:

Click on at top right of the 3D viewer for instructions on mouse operations.

The list will display all build-in characteristics. When users click on the characteristics in the list, the robot virtual interface located in the center will display the selected characteristics in dark blue, and users can delete, reset and perform other actions on the selected characteristics. When the robot is about to enter the deceleration zone, the robot will start deceleration in advance, but the state of the **Indication Light Ring** of the **End Module** will not change.

15.3 Add / Modify Page
 15.3.1 Plane Page

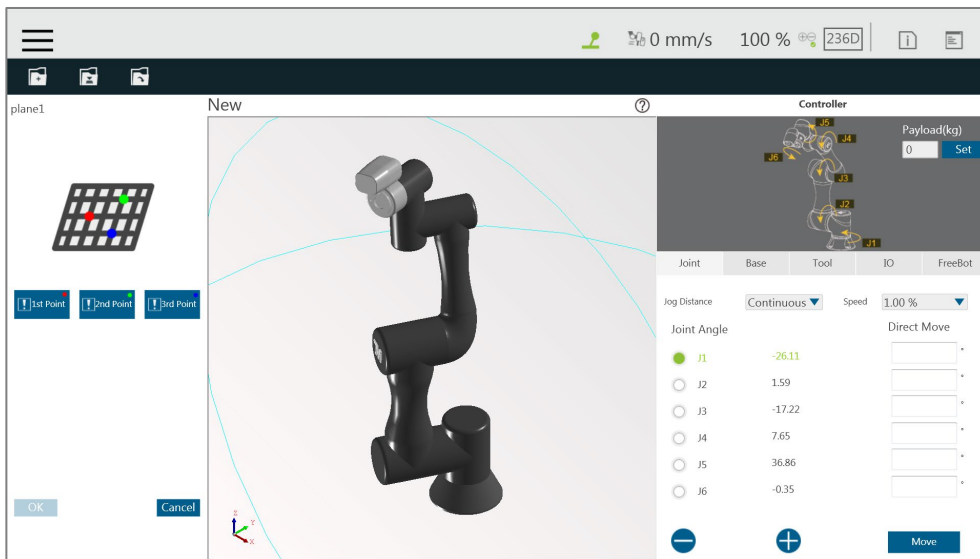
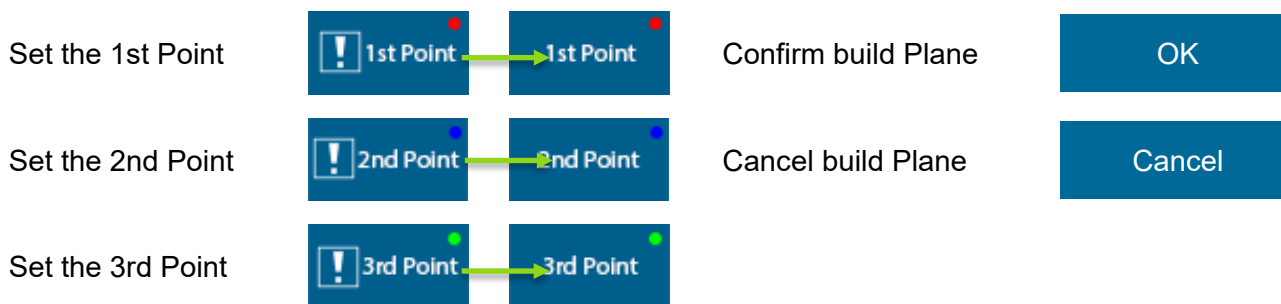

Figure 236: Plane

The **Add/Modify Plane** Page can be accessed by clicking the button to add a new plane or clicking button to reset characteristics after selecting the plane characteristics. On this page, users can build a plane by setting three points. The setting order of the three points can be random, and the robot virtual interface will display the corresponding color ball. When the three points are set, a dark blue virtual plane will appear. At this time, clicking **OK** will lead to building the plane. It is necessary to pay attention that once the phenomenon of common point or collinearity occurs, it is not possible to build the virtual plane. The button function list is shown below.



15.3.2 Cube Page

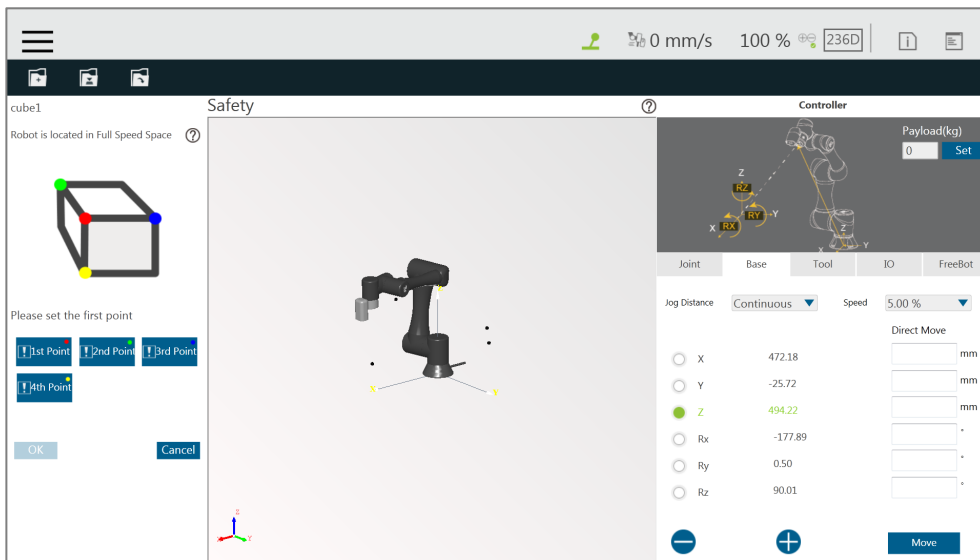
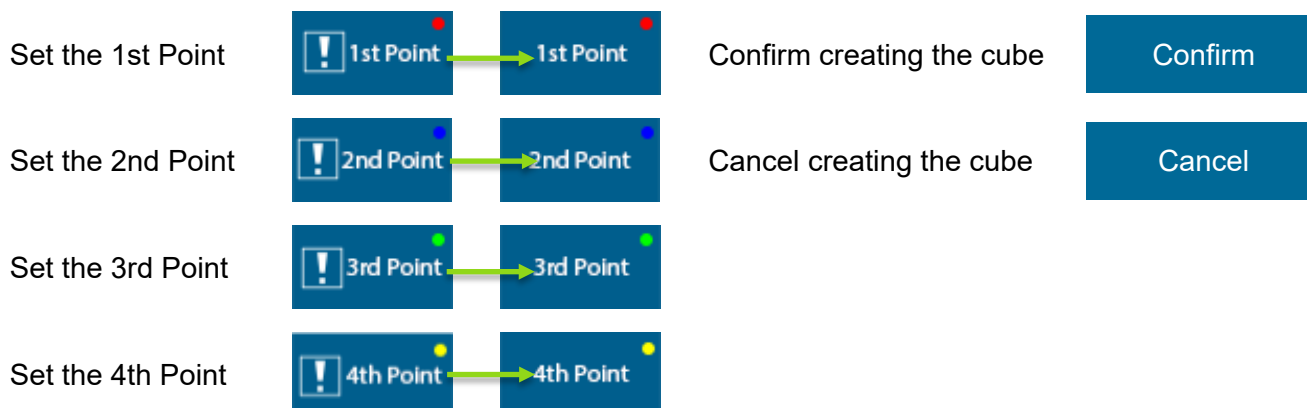

Figure 237: Cube (1/2)

The **Add/Modify Cube** Page can be accessed by clicking the button to add cube or clicking the button to reset characteristics after selecting the cube characteristics. On this page, users can build a cube with the four points setting by **TCP**. The setting order of the four points can be random but in accordance with relative relationships as illustrated on the screen. The robot virtual interface will display the corresponding color ball. When the four points are set, a dark blue virtual cube will appear. At this time, clicking the **OK** button will lead to building the cube. It is necessary to pay attention that once the phenomenon of common point or collinearity occurs, it is not possible to build the cube. The button function list is shown below.



Once completed building the operation space, users can identify objects in the 3D screen as shown below. The whole sphere is the maximum movable range of the robot, the reduced space is in green, the full speed space is in red, and the stop space is the space removed from the robot's movable range.

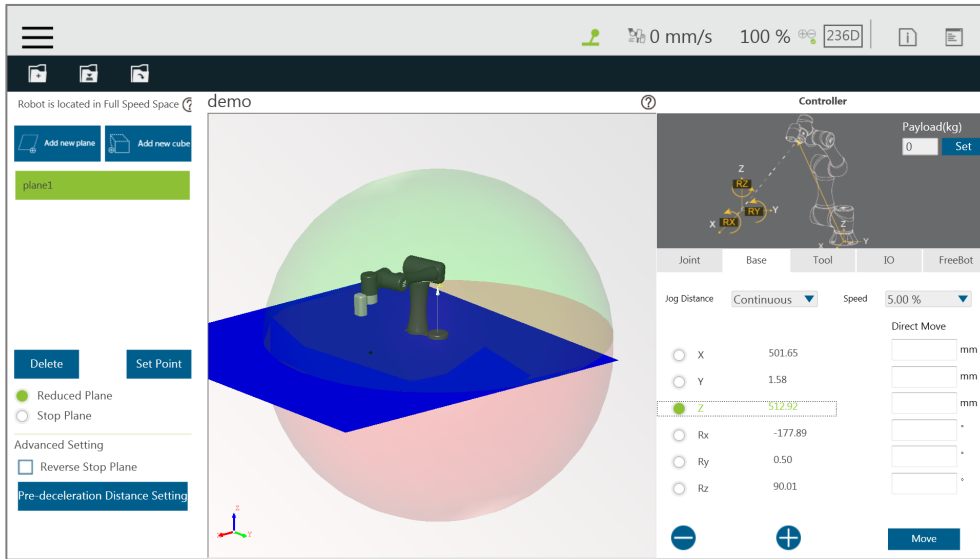

Figure 238: Cube (2/2)



DANGER:

The convenient setting of the operation space is achieved by a complex spatial geometry algorithm, which may result in a space division that is not as expected by users under certain specific setting conditions. Users must fully check whether the result of the space sphere in the 3D image is as expected before saving the settings. Improper use of a safe space configuration, or saving unexpected settings, or an incorrectly run project, can all cause situations where the robot hits a human body at full speed.

15.4 Operation Space Setting Page in the Project Editing Page

After building the plane, users can go to the **Project Editing Page** and click **Operation Space** in the project function menu for **Operation Space Setting**.

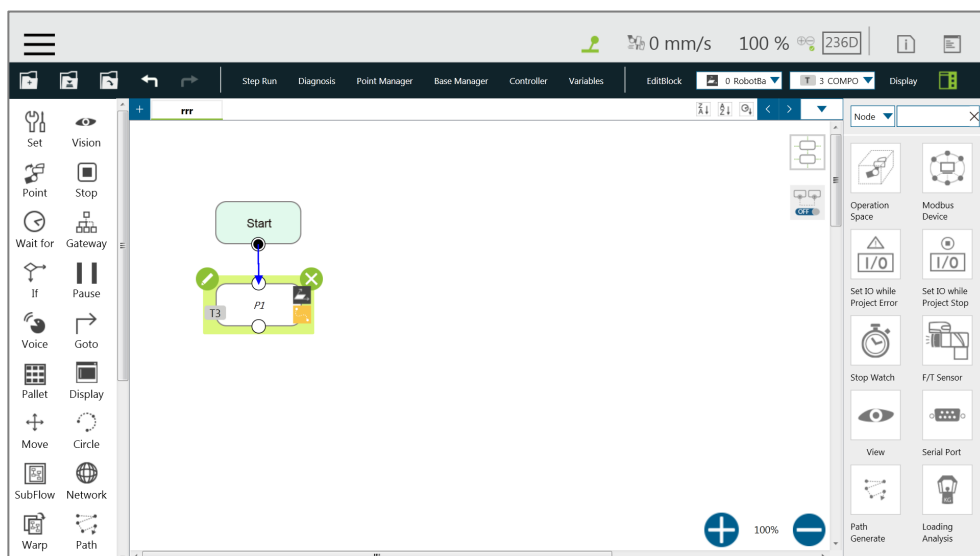

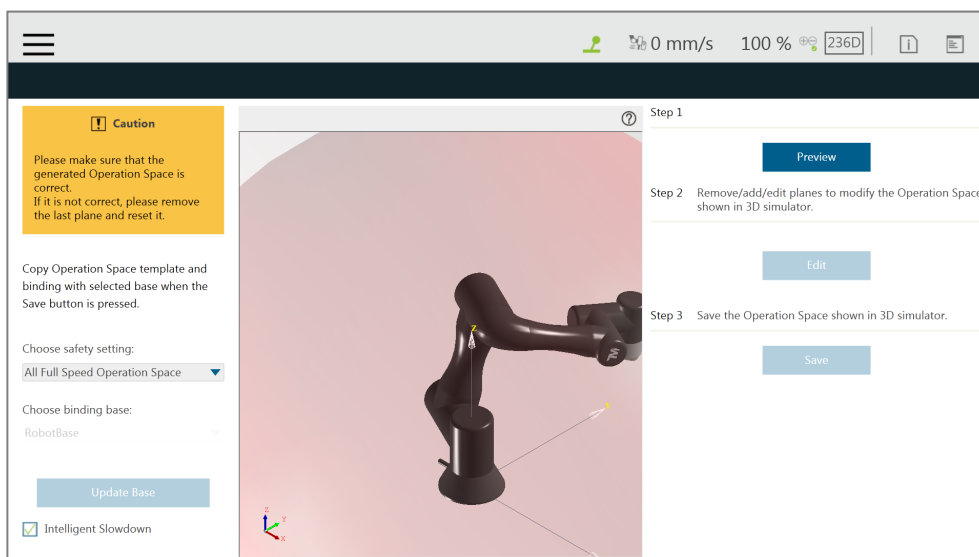

Figure 239: Project Editing Page and Operation Space Setting

The Intelligent Slowdown function in the lower left of the figure above provides the ability for the robot to automatically pre-decelerate in the schedule of the project node. If this function is checked, when the project is running, the system will calculate whether the robot's next node position crosses the space. If the space is crossed, then the robot will start deceleration at the current node.



DANGER:

The Intelligent Slowdown function only judges whether the initial position and end point of the robot **TCP** enters the deceleration zone from the full-speed zone or not. Therefore, if the initial position and the end point are both located in the full-speed zone, and the **TCP** position enters the deceleration zone during the operation, the smart pre-deceleration function will not activate.

In the **Project Function Menu** of **Project Editing Page**, click **Operation Space > Preview** to display the 3D simulator with the selected operation space in **Select Operation Space Setting** and the base in **Choose binding base**. To modify the operation space, click **Edit**. Users are responsible for checking the correctness of the displayed operation space and maintaining its safety before saving it. If not correct, click **Edit** to remove the last plane and set again. The system will save the operation space displayed in the 3D simulator after clicking **Save**. **Binding Base** is a convenient function for users to record the definition of the operations space in the ambient bases, but please note that binding is a one-time action. If the **Base** is updated in other interfaces after binding, it is necessary to go back to this page to bind again.

- **Preview:** Display the generated operation space on the 3D simulator.
- **Edit:** Delete, add, or edit planes to modify the operation space displayed in the 3D simulator.

- **Save:** Save the Operation Space displayed in the 3D Simulator.

After clicking the **Preview** button, if the set page needs to be modified, click the **Edit** button below to modify the screen.

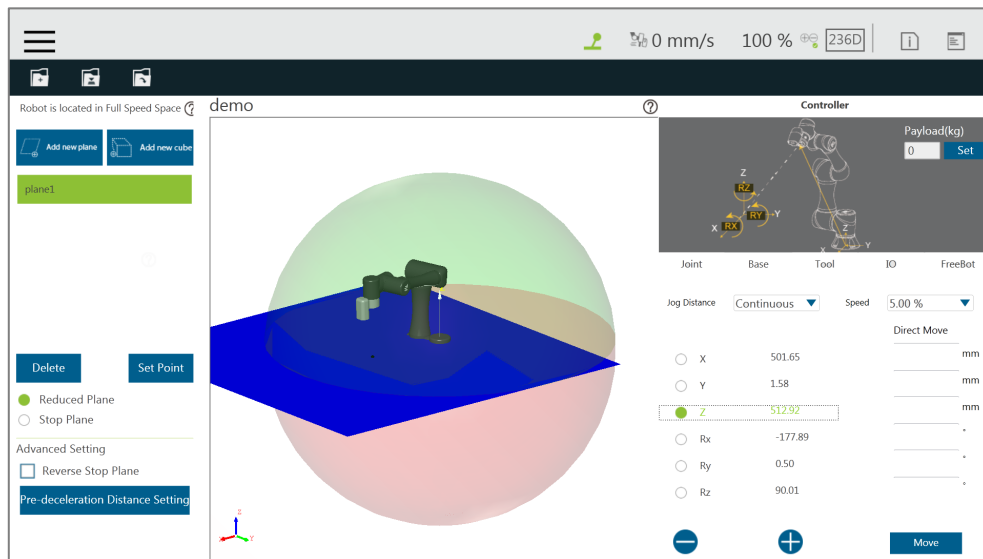

Figure 240: Click the Save Button to Save the File

If the modification is completed, click the Save button on the top left to save the file. If modification is not required, then click the back arrow on the top left to return to the setting page without saving.

15.5 Export/Import Operation Space

15.5.1 Export Operation Space

Users can export the saved operation space for use in general or along with the project for use in particular.

- For use in general, operation space links and related scenery files are exported together as steps below.
 1. Navigate to , click **System > Import/Export**.
 2. Click **Export** on the top left, and click **Operation**.
 3. Click **Export** at the bottom right to export.
- For use in particular with the project, operation space links and related scenery files are exported together along with the project file. Refer to examples in 5.8.6 Import/Export.

15.5.2 Import Operation Space

Users can import created operations spaces to use in TMflow.

Note

NOTE:

If imported from TMstudio, rename the file to **SafetySpace** and put the file in the path **TM_Export\Robotname** on a flash drive labeled **TMROBOT** where Robotname denotes the ID of the robot. After importing, users are able to open the operation space with the scenery file by clicking the open icon in the **Operation Space Setting Page**.

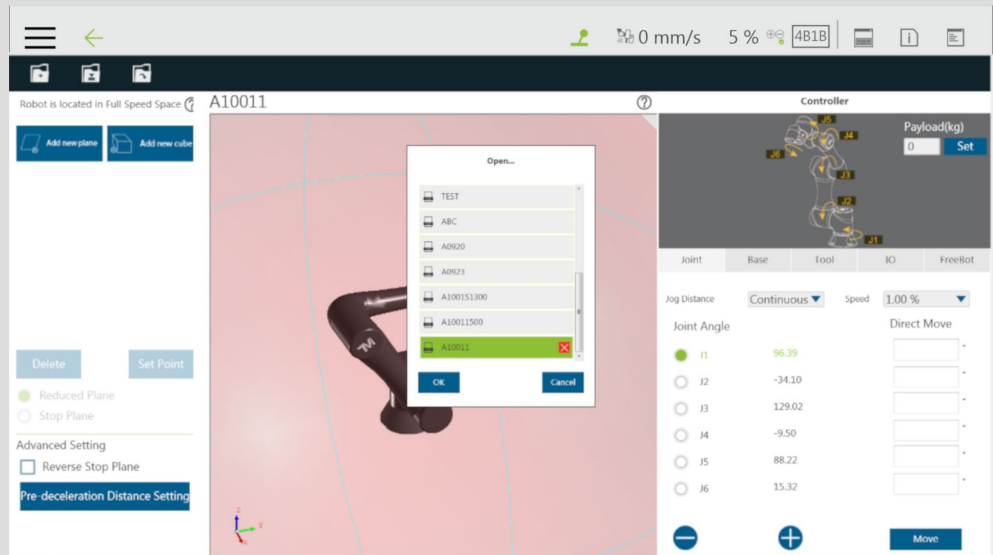

The icon before the file name denotes the operation space comes with the scenery file, and the object name and its dependent base will be shown at the top right of the 3D viewer when moving the mouse cursor on the object in the scenery file.

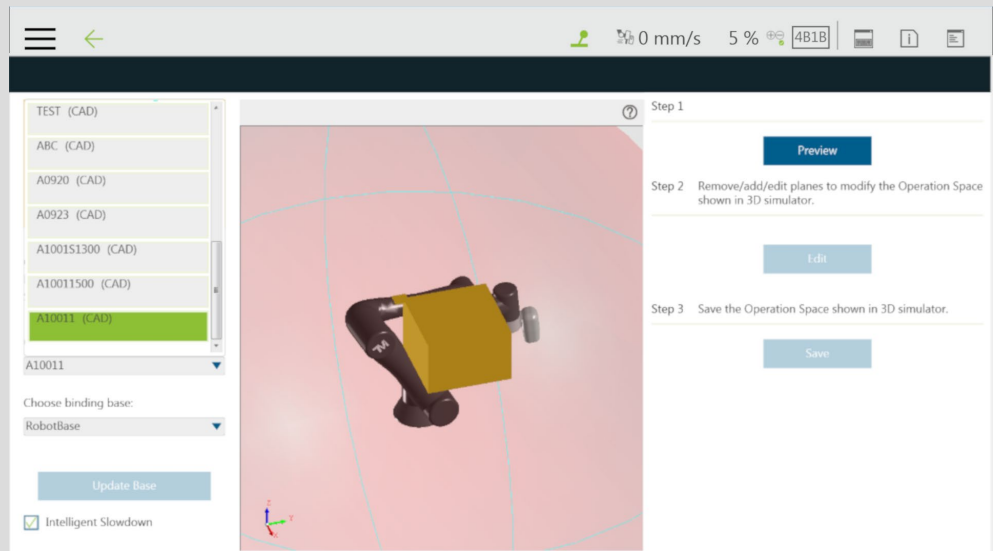

Users can select items named with (CAD) in the list at left as the operation space with the scenery file for the project. The actual position of the CAD in the scene will update as the dependent base updates. This is a great help for the collision check node to detect the collisions between the robot and the objects in the scene.

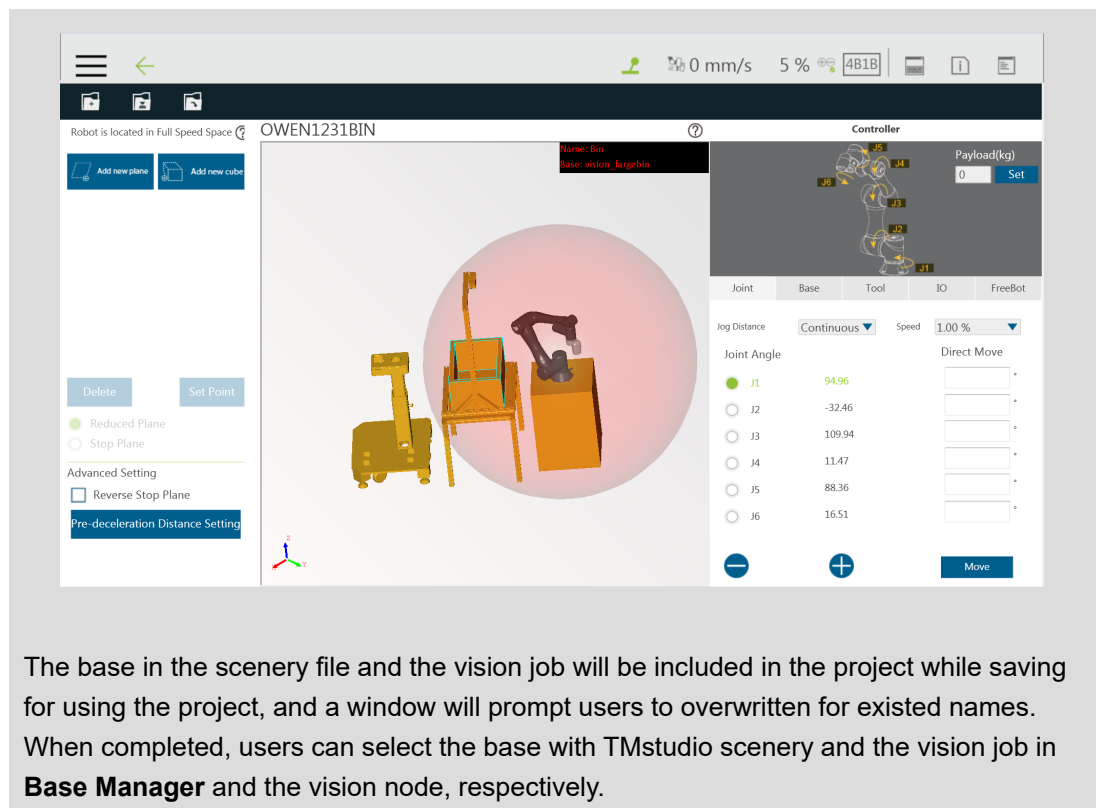

To import operation spaces:

1. Navigate to **≡**, click **System > Import/Export**.
2. Click **Import** on the top left, and click **Operation Space** at the bottom left.
3. Select the robot to apply the imported setting in the **Robot List** prompted and click **OK**.
4. Select the project to apply the imported setting in the **Project List** prompted and click **OK**.
5. Select the project to import in the **Import Project List** prompted and click **OK**.
6. Select the name of the setting listed in **Selected Files**.
7. Click **Import** at the bottom right to import the setting.

16. TM Component Editor

TM Component Editor provides developers the capability to compile nodes into components, which can be easily reused by other projects. It greatly simplifies the flow structure of repeating or similar applications. In addition, based on the diversity of product features, developer can plan the possible moving path of the robot in advance with **TM Component Editor** or design with the positioning of **TM Landmark** to create a variety of components applicable to screw driving, welding, polishing, and grinding.



IMPORTANT:

TM Component is not designed for confidential encapsulation. Do not use TM Component in confidential usage.

16.1 Starting to create your first component

16.1.1 Overview

A component can consist of a variety of the features to make the flow structure simple as well as reusable in other projects. **TM Component Editor** provides developers with a complete mechanism to create components. Among the nodes, the **Start** node is able to configure the component's basic parameters such as its display icon, its usage, as well as its available **Global Variables** and its instruments. Moreover, developers are able to provide users with the flexibility to modify the parameters on demand. To help users to understand the usage scenarios of the developer's component quickly, **TM Component Editor** manages a naming rule.

16.1.2 TM Component Editor settings

16.1.2.1 Start node

Developers can click on the **Start** node for basic settings. In the basic settings, Provider is the name of the developer, Name and Type stand for the name and the type of the node respectively, and Icon is the image to represent the component. In addition, **TM Component Editor** can pack available **Global Variables** and instruments together into the component, and show the results in the branches of the **Gateway** node.

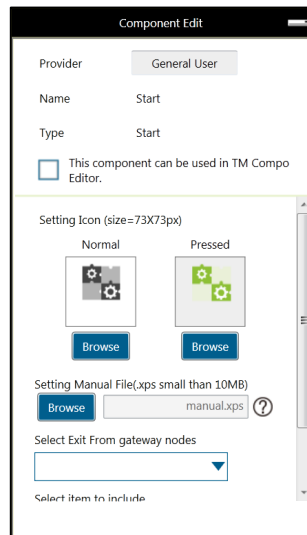

Figure 241: Start Node

- **Provider:** Provider is the name of the developer or the company that packs the component. When dragging a created component as a node in **TMflow**, the information of the developer will be displayed in the field as the creator.



IMPORTANT:

Components will not be saved if they do not follow the correct naming convention. This includes but is not limited to using “Omron” or “Techman” affiliated names as the provider.

- **Icon Name:** Users can use a desired name for the component listed in the node menu. The icon name is for used in the node menu only. Once dragged into flowing editing area, it displays the component name.
- **Name:** Name is the name of the currently selected node. Developers may edit the name in the edit function of the node to optimize the visibility of the flow. This item can be used by developers to check the correctness of the current modifying node.
- **Type:** Type can be used by developers to check the correctness of the current modifying node.
- **This component can be used in TM Component Editor:** This item checks if the component is available for using in TM Component Editor. Refer to 16.3.2 Use component in TM Component Editor for the usage.
- **Icon:** Developers can set up two different icons for “normal” and “clicked” status of the component. Only image files in the USB drive labeled with **TMROBOT** can be imported.

IMPORTANT

IMPORTANT:

The component's icon supports PNG image files only, and the suggested maximum resolution is 73 x 73 pixels to avoid distortion or blur.

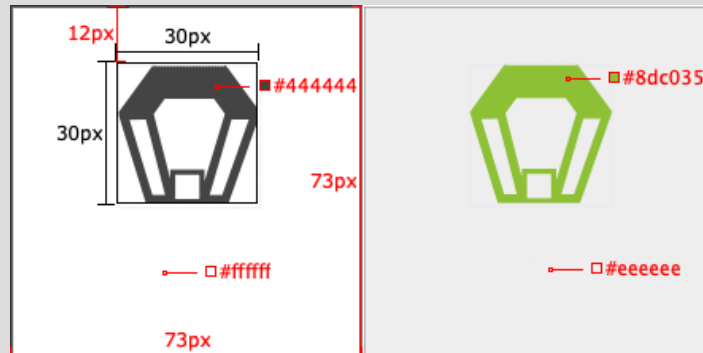

Figure 242: Component Icon Resolution

- **Manual:** Developers can import a manual file in XPS format, from the USB drive labeled with **TMROBOT**, to guide users. Once imported the XPS file, users can click the icon to check its correctness.

IMPORTANT

IMPORTANT:

Make sure the file size of your XPS is less than 10MB or it will not be accepted.

- **Select Exit From Gateway nodes:** This item sets the branches of the component. Developers have to select a **Gateway** node as the exit of the component and the possible results branch over the **Gateway** node exits according to the logic. Users can process the flow with the respective programs provided by the developers.

IMPORTANT

IMPORTANT:

You can change the variables in the results with the **SET** node while planning the flow, and use **Case** in the **Gateway** node to judge the variables in the results and lead the results to the different position. If the selected **Gateway** node as the exit comes with child nodes, the child nodes will be ignored.

- **Command List:** This item sets the checked command sets embedded into the **Component**. When users import the component, the checked command list will be imported also.
- **TCP List:** This item sets the checked **TCP** list embedded into the **Component**. When users import the **Component**, the parameters will be imported also. The prefix of the **TCP** has to go with the first two names (Application_Provider_) of the

project name in **TM Component Editor**; otherwise, they will not appear in **TM Component Editor**.

- **Global Variable List:** This item sets the **Global Variables** used by the developer embedded into the **Component**, so the variable conveyance in different **Components** is achievable. The first two names have to be identical to the names in the project; otherwise, they will not appear in **TM Component Editor**. For the naming rule of **TM Component Editor**, refer to 16.1.3 TM Component Editor Naming Rule.



IMPORTANT:

Inappropriate changes of the project names in **TM Component** may result in missing of the embedded **Global Variables**.

16.1.2.2 Node settings

- **Sort:** This item sorts the orders of the nodes present in the **Component**. The smaller the number is, the higher the order is.



IMPORTANT:

The available input range of the order to sort is from 0 to 1024. If the input number is beyond the maximum, the returned value is 1024.

- **Are setting items in this node visible:** This item sets the node in **TM Component Editor** to be editable by users. When an **IF** node is set to **Display** and its flow is packed in a component, clicking edit in the component will present the node in the component as shown below.

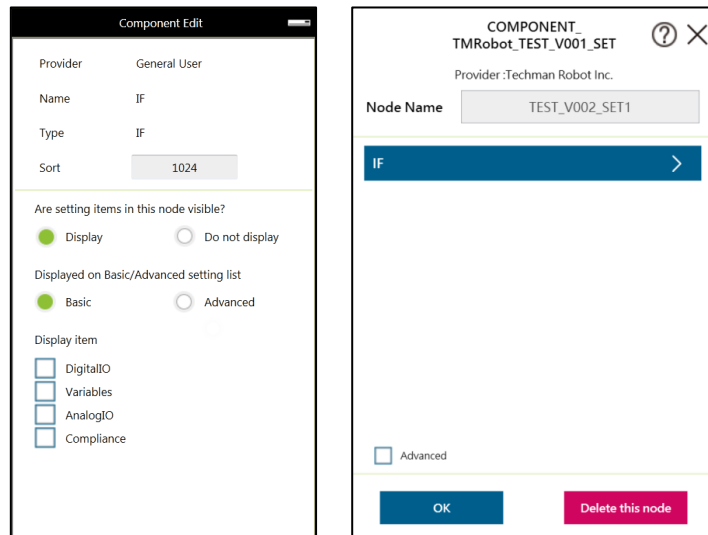

Figure 243: Node Setting (1/2)

- **Displayed on Basic/Advanced setting list:** This item sorts the nodes present in the component. Developers of **TM Component Editor** can partition the levels of the nodes present in the component. First-time users can begin with the basic functions and the simplified interface, and advanced users can check **Advanced** for more advanced applications.



IMPORTANT:

Once **Advanced** is checked, the nodes present in the component will be rearranged by the input number of Sort.

- **Display Item:** This item sets the items available for users to modify in the **Component**. For example, if the **IF** node is set to **Display** as shown below and **Digital I/O** and **Analog I/O** are both checked, after the component is dragged into the project, users can select parameters of **Digital I/O** and **Analog I/O** to append or modify by checking the boxes in **Display Item** of the **IF** node in the **Component**.

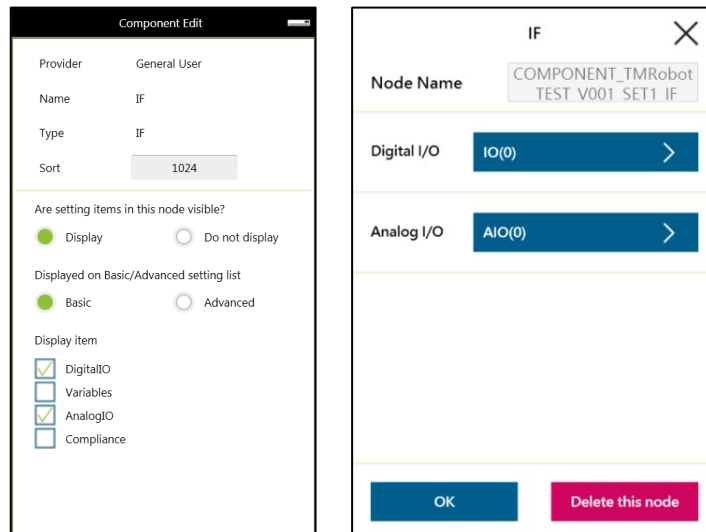

Figure 244: Node Setting (2/2)

- **DeviceReadOnly:** This item is applicable to force control related nodes. Developers can set the properties of the force sensing devices to **DeviceReadOnly** to lock available force sensing devices and prevent users from modifying them. Refer to 16.3.4 The example of point parameterization application for detailed applications.



NOTE:
The available display items of the force control node in component editor are the details of **Setpoint** or **Tracjectory**.

16.1.3 TM Component Editor Naming Rule

The naming rule is intended to help users understand the purpose of the component quickly and completely. To help developers understand component development consistently and intuitively, **TM Component Editor** regulates the naming in part of the parameters to enhance readability with applicable categories of components, which will go through one by one in the following.

16.1.3.1 Component Naming

The naming rule of **TM Component Editor** goes by Application_Provider_Model_Version_Function.

Name	Description & Examples
Application	GRIPPER
Provider	Omron
Model	Adaptive

Version	V001
Function	GRIP

Table 18: Component Naming



IMPORTANT:

Do not use reserved words such as var in naming.

The maximum characters available in naming compounded with the component and the vision task is 126, otherwise the vision task may not function normally.

Item	Rule	Examples		
		Component Name	Item Name	Name for Imported Component
Variable	component name #_item name	A_B_C_V001_D	var_A	A_B_C_V001_D1_var_A
point	component name #_item name	A_B_C_V001_D	P1	A_B_C_V001_D1_P1
Set	component name #_item name	A_B_C_V001_D	SET	A_B_C_V001_D1_SET
Base	component name #_item name	A_B_C_V001_D	Base1	A_B_C_V001_D1_Base1
Vision Base	vision_comp onent name #_item name	A_B_C_V001_D	vision_Landmark	vision_A_B_C_V001_D1_Land mark
Device	component name #_item name	A_B_C_V001_D	mrtu_Gripper	A_B_C_V001_D1_mrtu_Gripper
Global Variable	item name	A_B_C_V001_D	A_B_Variable	A_B_Variable
TCP	item name	A_B_C_V001_D	A_B_TCP	A_B_TCP

Table 19: Naming Rule for Items after Components

16.1.3.2 Global Variables Naming

The prefix of a **Global Variable** has to be the first two names (Application_Provider_) of the project name in **TM Component Editor**. Inappropriate naming of **Global Variables** may

result in existing **Global Variables** being overwritten. Refer to 16.3.1 Global Variables for **Global Variable** applications.

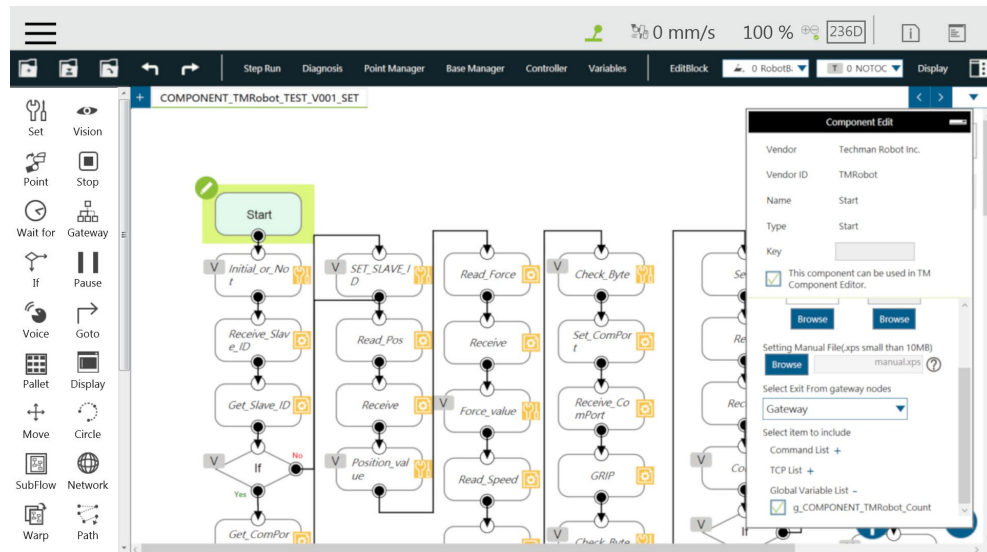

Figure 245: Global Variables Naming



IMPORTANT:

Inappropriate changes of project names in **TM Component** may result in missing of the embedded **Global Variables**.

16.2 Devices

In **TM Component Editor**, you can edit the devices in advance, such as **F/T Sensor devices**, **Modbus devices**, **Network devices**, and embed the devices in the **Component**. The supported devices of TM Robot will be covered one by one below.

16.2.1 Modbus Devices

In **TM Component Editor**, you can set the parameters of the Modbus TCP/RTU devices and have the devices embedded in the **Component**. By dragging the **Component** in **TMflow** to have a Modbus device added, users can configure the Modbus device in the list at the right of the screen.



IMPORTANT:

The local IP will not be embedded in the Modbus device of the component by default. To use a local IP, add a new device and input 127.0.0.1 and 502 as the IP address and port number respectively.

16.2.2 Network Devices

In **TM Component Editor**, users can add a new network device newly added by the **Network** node embedded to the **Component**. Dragging the **Component** in **TMflow** will add a **Network device**.

16.2.3 Force Sensing Devices

In **TM Component Editor**, you can have the parameters of communication and physics in the force sensing devices embedded in the **Component**. By dragging the component in **TMflow**, users can merely configure the serial port address to match the actually connected address for making use of the **Component** established with the device in the flow. If **DeviceReadOnly** is checked, users of the component will be limited to use the developer set devices. Refer to 16.3.5 The example of making parameterized devices for the method to limit available devices in the component

16.3 Features & Applicable Examples

This section goes through the principal ideas of programming, techniques, examples including **Global Variables**, **Subflows**, parameterizations, etc. The applicable methods and scenarios are introduced below as a reference for developers to program in simple ways.

16.3.1 Global Variables

Users can click **Global Variables** in **Robot Setting** to enter the **Global Variable** system. With **Global Variables**, **TM Component Editor** may deliver values to various **Components**. The example below divides the components of the **Gripper Button** into **SET**, **GRIP**, and **RELEASE**. **SET** is for setting parameters of the **Gripper Button**. **GRIP** and **RELEASE** go without parameter settings but merely hold and free the object respectively.

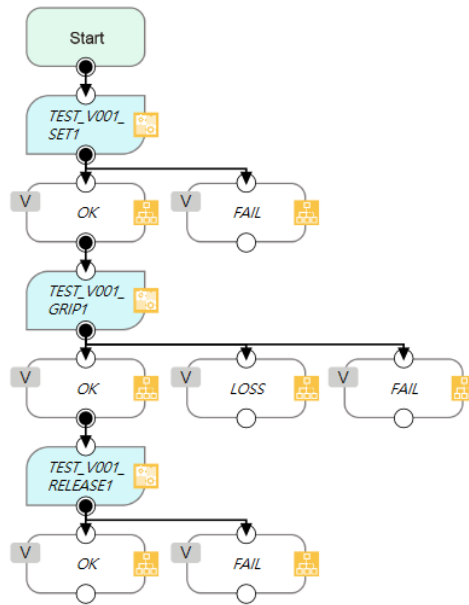

Figure 246: Global Variables

If parameters of the **Gripper Button** are set in **GRIP**, the settings in **GRIP** will refresh to the defaults when adding a new component, which means the parameters of **GRIP** of the **Gripper Button** will return to the values set by the developer. However, if the parameters are changed in **SET** as **Global Variables**, the **Gripper Button** will apply the user setting parameters while executing **GRIP** and **RELEASE**.



IMPORTANT:

Global Variables will not lose their values because of a system shutdown. When using a **Global Variable**, the prefix of the **Global Variable** has to go with the first two names (Application_Provider_) of the project name in **TM Component Editor**.

16.3.2 Use component in TM Component Editor

A **TM Component Editor** programmed component can check “**This component can use in TM Component Editor**” in the right via the **Start** node. This feature is applicable to the secondary development of **Components** such as the developers of force sensing devices, who can integrate the existing **Component** of the **Gripper Button** to expand the component’s functions and save time and development costs.



IMPORTANT:

Once the component established by packing the project, the parameters of the component used in **TMflow** will apply the names, Application_Provider_Model_Version_Function, in order. Users have to define the prefixes of the **Components** used in **TM Component Editor** on their own.



NOTE:
 If variables of a **Component** in **TM Component Editor** are set for users' modifications, developers can make the respective variables in the **Component** equal to custom variables and types in **TM Component Editor**, and have users modify the **Variables** by the **SET** node.

16.3.3 Component Inheritance

If there is a **Component** node in **TMflow**, then dragging another identical **Component** can select whether to inherit the previous **Component**. If selected to inherit, the declared variables, devices, coordinates, and TCP parameters will be shared; otherwise, different serial names will apply to the declared variables, devices, coordinates, and **TCP** parameters. If the **Component** is generated by the **Gripper Button**, it will inherit from the last inherited source first. If the last operation is add or there is no source of the last inheritance, it will inherit from the last added item.



IMPORTANT:
 Inheritance merely shares variables, bases, positions, and **TCP** parameters from components, but not the modified values of the parameters in the node. (The setting values in the nodes will keep the defaults of the developers.)

16.3.4 The example of point parameterization application

If developers are unable to estimate the number of points in **TM Component Editor**, they can achieve through parameterization and the string processing function in **TMflow**. As an example, the component programming of the plugin illustrates below.

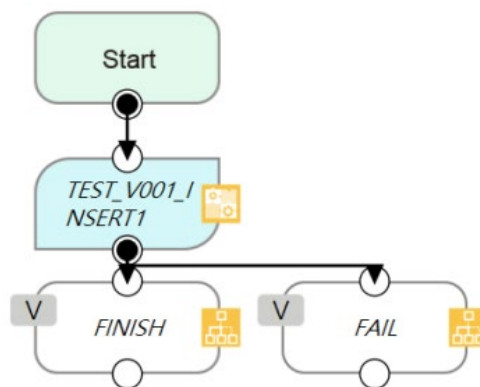

Figure 247: The Example of Point Parameterization Application (1/4)

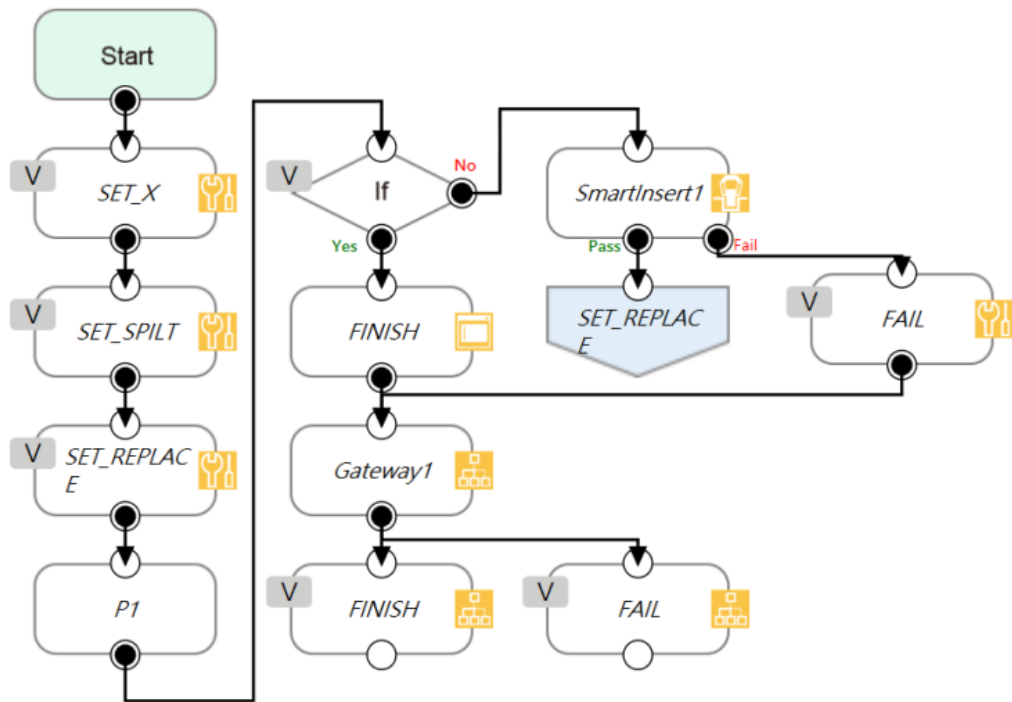

Figure 248: The Example of Point Parameterization Application (2/4)

In the flow above, the coordinate of the **Component** plugin comes from a 3D CAD file. To developers, the user's coordinates and the number remain unknown. This example uses the X-axis as an explanation. Developers can plan the string structure that users understand easily in advance, and use the string processing function in **TMflow** to retrieve the position of the X-axis by means of the matrix format. Then, developers can replace the position of a single point with the parameterization function for the string returned. Finally, determine whether all plug-in processes are completed according to the size of the matrix.



Note

NOTE:

Parameterization does not include the status of **Operation Space**, **Set IO while Project Error**, **Set IO while Project Stop**, and **Stop Watch**.

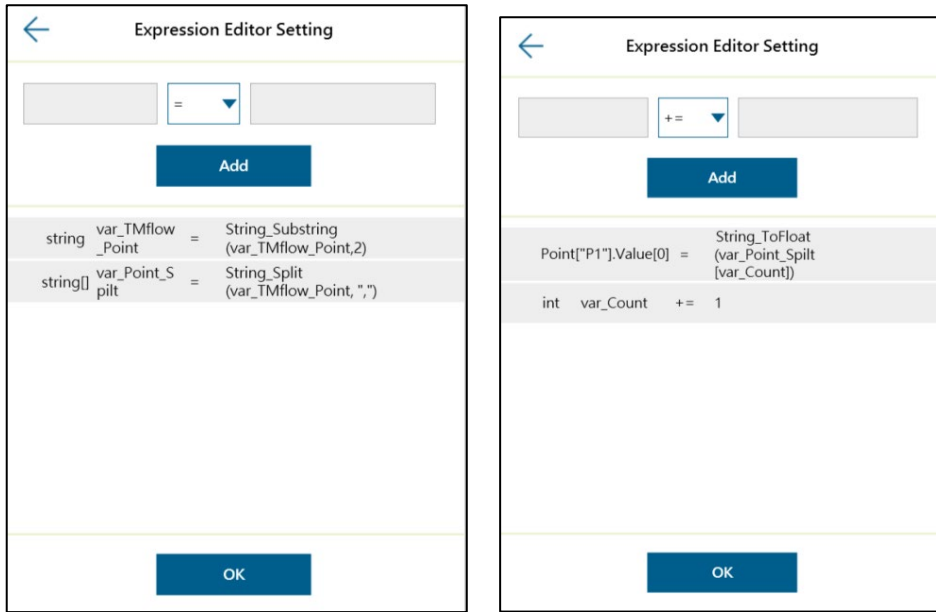

Figure 249: The Example of Point Parameterization Application (3/4)

With this architecture, the algorithm is programmed by **TMflow** to disassemble the string to deal with the number of points unknown. The following figure shows users an example of a string structure in this component. Users can change the point as needed.

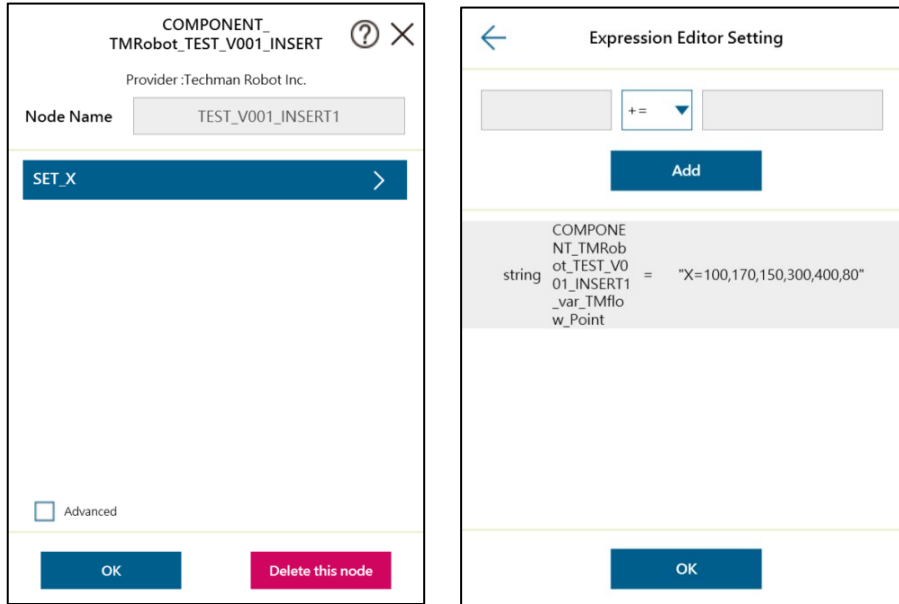

Figure 250: The Example of Point Parameterization Application (4/4)



NOTE:

The point positions required in the example above can be achieved by using the **Command** node to read the notepad in the network shared folder or by importing from a text file in **Variable** if the data type is string.

16.3.5 The example of making parameterized devices

As shown below, developers can use the device parameterization function to restrict modules under the name of the device and use the **DeviceReadOnly** property to prohibit users from changing devices. This method can limit available devices in the component.

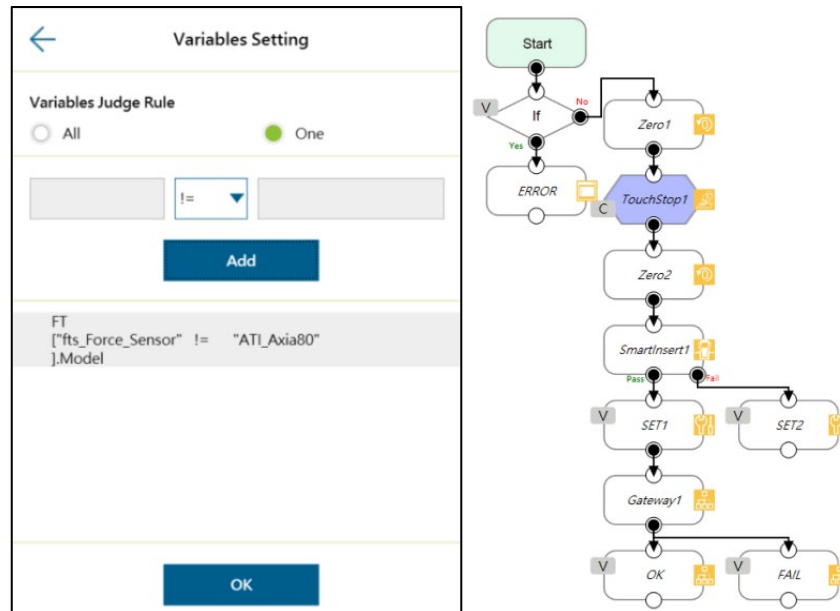

Figure 251: The Example of Making Parameterized Devices

16.3.6 Use thread in TM Component Editor

The thread function is available in **TM Component Editor**, so status monitoring and data acquisition are independent of the robot, and the thread page precedes data interception and analysis. Users are able to read the data or renew the variables in the thread page. Components cannot be dragged into thread pages of the project. If needed, users can delete the page by selecting delete at the edit window of the **Start** node in the child page.



IMPORTANT:

If there is a component coming with the thread page in **TMflow**, no new thread page will come into being when clicking inherit. However, a new thread page will come into being when clicking add a new component. Developers have to be careful to plan the flow to avoid logical conflicts resulted from threads between components.



NOTE:

Non-pause Thread is applicable to a component.

16.3.7 Use subflow in TM Component Editor

While programming components in **TM Component Editor**, as the number of nodes increases, some blocks in the **Component** could be reused or nodes in the blocks could be categorized. It is possible that the poor modifications in the nodes of the block results in inconsistent parameters. Therefore, using the **Subflow** node page to frame the concept of modularization, users can simplify the flow of the component programming as well as enhance the readability of the logic in the programming. It is recommended to use the **Subflow** pages as much as possible while programming the **Component**. To delete the page, select delete at the edit window of the **Start** node in the child page.

16.3.8 Hide parameters

TM Component Editor lets developers cover part of parameters. After selecting variables, bases, and points in **TM Component Editor**, developers can select whether to show parameters in the base manager, the base list, the point manager, and the variable list in **TMflow** after dragging the packed **Component** in the flow.

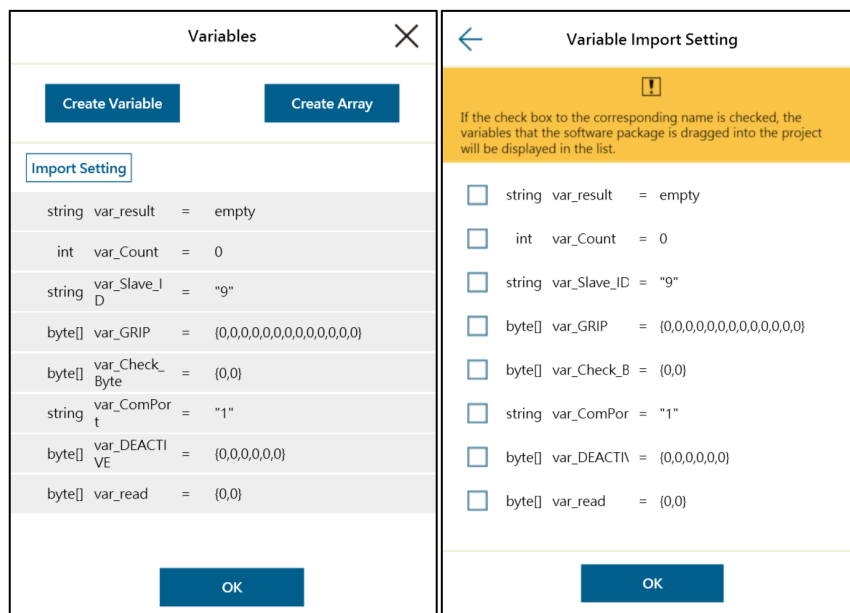

Figure 252: Hide Parameters

16.4 Using your component

Once you have completed the **Component** programming, you can export the **Component** to various projects or make the **Component** available to others. The following goes through how to open the **Component** and use it in the **Project Page** as well as how to make it available to others.

16.4.1 Open the component

When selecting the **Gateway** node as the exit in **TM Component Editor** and clicking save, **TMflow** will create a component with the project. In the meantime, users can activate the created **Component** in the **Component List** by navigating to **≡ > Setting > Component**, and the **Component** should come out as a node to the left of flow.

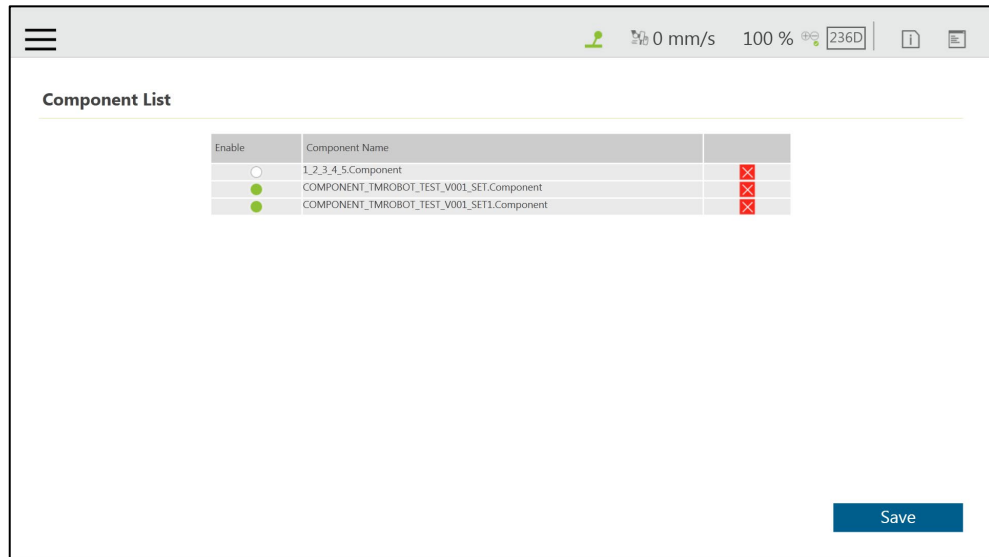

Figure 253: Open the Component

16.4.2 Import/Export Components

Navigate to **≡ > System > Import/Export** to export the component to the USB driver labeled with **TMROBOT** and import the component onto the users' TM control box and to make it available to users.



IMPORTANT:

- After being imported, it is required to activate the component in the **Component List** by navigating to **≡ > Setting > Component** before using.
- A component that is imported with the same name as a component in use will overwrite the settings of the component in use.



NOTE:

Components created in newer versions of TMflow are not applicable to older versions of TMflow.

17. Collision Check Node

The Collision Check Node comes with solutions to provide against issues of the robot's interfering in the self test and the collisions between the gripper and the box. With proper settings and editing based on the scene exported by TMstudio or the simple box container built in TMvision, users can simulate robot motions with robot parts, tools, and virtual boxes to check target motions in advance for collisions in 3D random bin picking applications, large tools, critical poses, and etc.

Before using the collision check node in TMflow, users should use TM Studio to configure the robot model and import the gripper CAD file for the zero point and the angle settings with the flange attached. When the TCP of the gripper is set, export the gripper CAD file zipped with files of xml, tcp, and stp to a flash drive labeled **TMROBOT**. Next, refer to 5.8.6 Import/Export to import the zipped file in TMflow by selecting **TCP** for the data type, and refer to 8.2.2 Create Tool Center Point by Input Parameters to adjust values. Also, users can add a new vision job to generate a vision base array after recognized to use in the collision check node.

In TMflow, drag a collision check node from the node menu to the **Flow Editing Area**, and use the node to create a subflow for teaching points. The maximum nodes available in this subflow is 100. The teaching points will be checked with collisions. Once the flow turns to the collision check node in the project page, the flow proceeds to the nodes in the subflow for collision checking. If there is no collision, the flow will depart from **Pass** of the collision check node; otherwise, the flow will depart from **Fail** of the collision check node. In addition, users can set the **Safety Distance** as a buffer for the robot to detect collisions and select **Simulation Speed** to apply to the trial run in the 3D simulator.

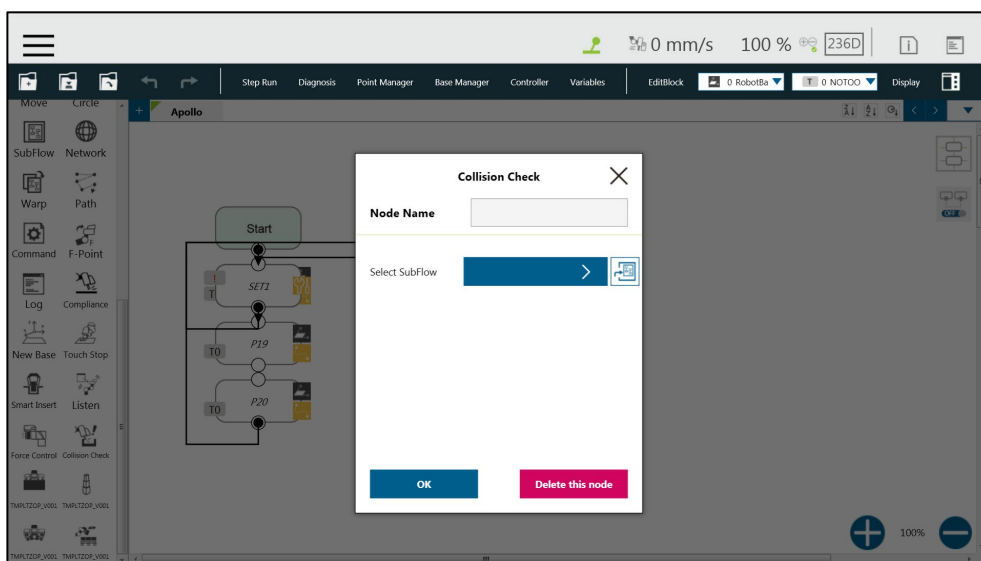

Figure 254: Collision Check Node

Appendix A: Modbus List

Classify	Function Code	Signal Type	R/W	Note
Read coils	01	Digital Output	R	TMflow Modbus signal type and Modbus function code table.
Read discrete inputs	02	Digital Input	R	
Read holding registers	03	Register Output	R	
Read input registers	04	Register Input	R	
Write single coil	05	Digital Output	W	
Write single register	06	Register Output	W	
Write multiple coils	15	Digital Output	W	
Write multiple registers	16	Register Output	W	

Table 20: Modbus – Classify

Robot Status 1	FC	Address ₁₀	Address ₁₆	Type	R/W	Note
Error or Not	02	7201	1C21	Bool	R	Yes:1 No: 0
Project Running or Not	02	7202	1C22	Bool	R	Yes:1 No: 0
Project Editing or Not	02	7203	1C23	Bool	R	Yes:1 No: 0
Project Pause or Not	02	7204	1C24	Bool	R	Yes:1 No: 0
Get Control or Not	02	7205	1C25	Bool	R	Yes:1 No: 0
Light	01/05	7206	1C26	Bool	R/W	Enable: 1 Disable: 0
Safety IO (User Connected External Safeguard Input Port (Pause))	02	7207	1C27	Bool	R	Triggered: 1 Restored: 0
E-Stop	02	7208	1C28	Bool	R	Triggered: 1 Restored: 0

Table 21: Modbus – Robot Status 1

Robot Status 2	FC	Address ₁₀	Address ₁₆	Type	R/W	Note
Auto Remote Mode	02	7209	1C29	Bool	R	Enable: 1

Enable or not						Disable: 0
Auto Remote Mode Active	05	7210	1C2A	Bool	W	Active: 1 Inactive: 0 (Need Get Control) (In Auto Mode)
Auto Remote Mode Active	02	7210	1C2A	Bool	R	Active: 1 Inactive: 0
Speed Adjustment Enable or not	02	7211	1C2B	Bool	R	Enable: 1 Disable: 0

Table 22: Modbus – Robot Status 2

Control Box DI/O	FC	Address ₁₀	Address ₁₆	Type	R/W	Note
DO 0	01/05	0000	0000	Bool	R/W	High: 1 Low: 0
DO 1	01/05	0001	0001	Bool	R/W	
DO 2	01/05	0002	0002	Bool	R/W	
DO 3	01/05	0003	0003	Bool	R/W	
DO 4	01/05	0004	0004	Bool	R/W	
DO 5	01/05	0005	0005	Bool	R/W	
DO 6	01/05	0006	0006	Bool	R/W	
DO 7	01/05	0007	0007	Bool	R/W	
DO 8	01/05	0008	0008	Bool	R/W	
DO 9	01/05	0009	0009	Bool	R/W	
DO 10	01/05	0010	000A	Bool	R/W	
DO 11	01/05	0011	000B	Bool	R/W	
DO 12	01/05	0012	000C	Bool	R/W	
DO 13	01/05	0013	000D	Bool	R/W	
DO 14	01/05	0014	000E	Bool	R/W	
DO 15	01/05	0015	000F	Bool	R/W	
DI 0	02	0000	0000	Bool	R	
DI 1	02	0001	0001	Bool	R	
DI 2	02	0002	0002	Bool	R	
DI 3	02	0003	0003	Bool	R	
DI 4	02	0004	0004	Bool	R	
DI 5	02	0005	0005	Bool	R	
DI 6	02	0006	0006	Bool	R	
DI 7	02	0007	0007	Bool	R	

DI 8	02	0008	0008	Bool	R	
DI 9	02	0009	0009	Bool	R	
DI 10	02	0010	000A	Bool	R	
DI 11	02	0011	000B	Bool	R	
DI 12	02	0012	000C	Bool	R	
DI 13	02	0013	000D	Bool	R	
DI 14	02	0014	000E	Bool	R	
DI 15	02	0015	000F	Bool	R	

Table 23: Modbus – Control Box DI/O

End Module	FC	Address ₁₀	Address ₁₆	Type	R/W	Note
DI 0	02	0800	0320	Bool	R	High: 1 Low: 0
DI 1	02	0801	0321	Bool	R	
DI 2	02	0802	0322	Bool	R	
DO 0	01/05	0800	0320	Bool	R/W	
DO 1	01/05	0801	0321	Bool	R/W	
DO 2	01/05	0802	0322	Bool	R/W	
DO 3	01/05	0803	0323	Bool	R/W	
AI 0	04	0800~0801	0320~0321	Float	R	

Table 24: Modbus – End Module

Control Box AI/O	FC	Address ₁₀	Address ₁₆	Type	R/W	Note
AO 0	03/16	0000~0001	0000~0001	Float	R/W	
AI 0	04	0000~0001	0000~0001	Float	R	
AI 1	04	0002~0003	0002~0003	Float	R	

Table 25: Modbus – Control Box AI/O

External Module	FC	Address ₁₀	Address ₁₆	Type	R/W	Note
AO	03/16	starting with 0900~0901 (Max:1698~1699)	starting with 0384 ~0385 (Max: 06A2~06A3)	Float	R/W	
AI	04	starting with 0900~0901 (Max:1698~1699)	starting with 0384 ~0385 (Max: 06A2~06A3)	Float	R	
DO	01/05	starting with	starting with	Bool	R/W	

		0900 (Max:1699)	0384 (Max: 06A2)			
DI	02	starting with 0900 (Max:1699)	starting with 0384 (Max: 06A2)	Bool	R	

Table 26: Modbus – External Module



NOTE:

$$(AIO\ Address_{10} = 0900 + 100 \times M + N \sim 0901 + 100 \times M + N)$$

$$(DIO\ Address_{10} = 0900 + 100 \times M + N)$$

- 0900 is the starting address for all external modules, and each module comes an interval of 100 between its starting address and the starting address of the other external modules.
- M = the external module number starting with 0.
- N = the number of expansion I/Os on the external module starting with 0.

Suppose you have 2 external modules with 64 expansion I/Os on each. The external module numbers will be 0 and 1 respectively. The addresses in decimal of the first external module are ranging from 0900 to 0963, and the addresses in decimal of the second external module are ranging from 1000 to 1063.

Safety Connector	FC	Address ₁₀	Address ₁₆	Type	R/W	Note1	Note2
SO 0	02	0100	0064	Bool	R	Robot ESTOP Output	Support Hardware 3.2 or newer version only. High: 1 Low: 0
SO 1	02	0101	0065	Bool	R	User Connected External Safeguard Output	
SO 2	02	0102	0066	Bool	R	User Connected External Safeguard Output for Human–Machine Safety Settings	
SO 3	02	0103	0067	Bool	R	Robot Internal Protective Stop Output	
SO 4	02	0104	0068	Bool	R	Robot Encoder Standstill Output	

Table 27: Safety Connector (1/2)

Safety Connector	FC	Address ₁₀	Address ₁₆	Type	R/W	Note1	Note2
SI 0	02	0200	00C8	Bool	R	User Connected ESTOP Input	Support Hardware 3.2 or newer version only. High: 1 Low: 0
SI 1	02	0201	00C9	Bool	R	User Connected External Safeguard Input (Pause)	
SI 2	02	0202	00CA	Bool	R	User Connected External Safeguard Input for Human–Machine Safety Settings (Collaborative)	
SI 3	02	0203	00CB	Bool	R	User Connected Enabling Device Input	
SI 4	02	0204	00CC	Bool	R	User Connected ESTOP Input without Robot ESTOP Output	

Table 28: Safety Connector (2/2)

Robot Coordinate	FC	Address ₁₀	Address ₁₆	Type	R/W	Note1	Note2
X (Cartesian coordinate w.r.t. current Base without tool)	04	7001~7002	1B59~1B5A	Float	R	Dword	mm
Y (Cartesian coordinate w.r.t. current Base without tool)	04	7003~7004	1B5B~1B5C	Float	R	Dword	mm
Z (Cartesian coordinate w.r.t. current Base without tool)	04	7005~7006	1B5D~1B5E	Float	R	Dword	mm
Rx (Cartesian coordinate w.r.t. current Base without tool)	04	7007~7008	1B5F~1B60	Float	R	Dword	degree
Ry (Cartesian coordinate w.r.t. current Base without tool)	04	7009~7010	1B61~1B62	Float	R	Dword	degree
Rz (Cartesian coordinate w.r.t. current Base without tool)	04	7011~7012	1B63~1B64	Float	R	Dword	degree
Joint 1	04	7013~7014	1B65~1B66	Float	R	Dword	degree
Joint 2	04	7015~7016	1B67~1B68	Float	R	Dword	degree
Joint 3	04	7017~7018	1B69~1B6A	Float	R	Dword	degree

Joint 4	04	7019~7020	1B6B~1B6C	Float	R	Dword	degree
Joint 5	04	7021~7022	1B6D~1B6E	Float	R	Dword	degree
Joint 6	04	7023~7024	1B6F~1B70	Float	R	Dword	degree
X (Cartesian coordinate w.r.t. current Base with tool)	04	7025~7026	1B71~1B72	Float	R	Dword	mm
Y(Cartesian coordinate w.r.t. current Base with tool)	04	7027~7028	1B73~1B74	Float	R	Dword	mm
Z (Cartesian coordinate w.r.t. current Base with tool)	04	7029~7030	1B75~1B76	Float	R	Dword	mm
Rx (Cartesian coordinate w.r.t. current Base with tool)	04	7031~7032	1B77~1B78	Float	R	Dword	degree
Ry (Cartesian coordinate w.r.t. current Base with tool)	04	7033~7034	1B79~1B7A	Float	R	Dword	degree
Rz (Cartesian coordinate w.r.t. current Base with tool)	04	7035~7036	1B7B~1B7C	Float	R	Dword	degree
X (Cartesian coordinate w.r.t. Robot Base without tool)	04	7037~7038	1B7D~1B7E	Float	R	Dword	mm
Y (Cartesian coordinate w.r.t. Robot Base without tool)	04	7039~7040	1B7F~1B80	Float	R	Dword	mm
Z (Cartesian coordinate w.r.t. Robot Base without tool)	04	7041~7042	1B81~1B82	Float	R	Dword	mm
Rx (Cartesian coordinate w.r.t. Robot Base without tool)	04	7043~7044	1B83~1B84	Float	R	Dword	degree
Ry (Cartesian coordinate w.r.t. Robot Base without tool)	04	7045~7046	1B85~1B86	Float	R	Dword	degree
Rz (Cartesian coordinate w.r.t. Robot Base without tool)	04	7047~7048	1B87~1B88	Float	R	Dword	degree
X (Cartesian coordinate w.r.t. Robot Base with tool)	04	7049~7050	1B89~1B8A	Float	R	Dword	mm
Y (Cartesian coordinate w.r.t. Robot Base with tool)	04	7051~7052	1B8B~1B8C	Float	R	Dword	mm
Z (Cartesian coordinate w.r.t. Robot Base with tool)	04	7053~7054	1B8D~1B8E	Float	R	Dword	mm
Rx (Cartesian coordinate w.r.t. Robot Base with tool)	04	7055~7056	1B8F~1B90	Float	R	Dword	degree
Ry (Cartesian coordinate w.r.t. Robot Base with tool)	04	7057~7058	1B91~1B92	Float	R	Dword	degree

Robot Base with tool)							
Rz (Cartesian coordinate w.r.t. Robot Base with tool)	04	7059~7060	1B93~1B94	Float	R	Dword	degree

Table 29: Modbus – Robot Coordinate

Robot Coordinate (When Touch Stop node is triggered)	FC	Address ₁₀	Address ₁₆	Type	R/W	Note1	Note2
X (Cartesian coordinate w.r.t. current Base without tool)	04	7401~7402	1CE9~1CEA	Float	R	Dword	mm
Y (Cartesian coordinate w.r.t. current Base without tool)	04	7403~7404	1CEB~1CEC	Float	R	Dword	mm
Z (Cartesian coordinate w.r.t. current Base without tool)	04	7405~7406	1CED~1CEE	Float	R	Dword	mm
Rx (Cartesian coordinate w.r.t. current Base without tool)	04	7407~7408	1CEF~1CF0	Float	R	Dword	degree
Ry (Cartesian coordinate w.r.t. current Base without tool)	04	7409~7410	1CF1~1CF2	Float	R	Dword	degree
Rz (Cartesian coordinate w.r.t. current Base without tool)	04	7411~7412	1CF3~1CF4	Float	R	Dword	degree
Joint 1	04	7413~7414	1CF5~1CF6	Float	R	Dword	degree
Joint 2	04	7415~7416	1CF7~1CF8	Float	R	Dword	degree
Joint 3	04	7417~7418	1CF9~1CFA	Float	R	Dword	degree
Joint 4	04	7419~7420	1CFB~1CFC	Float	R	Dword	degree
Joint 5	04	7421~7422	1CFD~1CFE	Float	R	Dword	degree
Joint 6	04	7423~7424	1CFF~1D00	Float	R	Dword	degree
X (Cartesian coordinate w.r.t. current Base with tool)	04	7425~7426	1D01~1D02	Float	R	Dword	mm
Y (Cartesian coordinate w.r.t. current Base with tool)	04	7427~7428	1D03~1D04	Float	R	Dword	mm
Z (Cartesian coordinate w.r.t. current Base with tool)	04	7429~7430	1D05~1D06	Float	R	Dword	mm
Rx (Cartesian coordinate w.r.t. current Base with tool)	04	7431~7432	1D07~1D08	Float	R	Dword	degree
Ry (Cartesian coordinate w.r.t. current Base with tool)	04	7433~7434	1D09~1D0A	Float	R	Dword	degree

Rz (Cartesian coordinate w.r.t. current Base with tool)	04	7435~7436	1D0B~1D0C	Float	R	Dword	degree
X (Cartesian coordinate w.r.t. Robot Base without tool)	04	7437~7438	1D0D~1D0E	Float	R	Dword	mm
Y (Cartesian coordinate w.r.t. Robot Base without tool)	04	7439~7440	1D0F~1D10	Float	R	Dword	mm
Z (Cartesian coordinate w.r.t. Robot Base without tool)	04	7441~7442	1D11~1D12	Float	R	Dword	mm
Rx (Cartesian coordinate w.r.t. Robot Base without tool)	04	7443~7444	1D13~1D14	Float	R	Dword	degree
Ry (Cartesian coordinate w.r.t. Robot Base without tool)	04	7445~7446	1D15~1D16	Float	R	Dword	degree
Rz (Cartesian coordinate w.r.t. Robot Base without tool)	04	7447~7448	1D17~1D18	Float	R	Dword	degree
X (Cartesian coordinate w.r.t. Robot Base with tool)	04	7449~7450	1D19~1D1A	Float	R	Dword	mm
Y (Cartesian coordinate w.r.t. Robot Base with tool)	04	7451~7452	1D1B~1D1C	Float	R	Dword	mm
Z (Cartesian coordinate w.r.t. Robot Base with tool)	04	7453~7454	1D1D~1D1E	Float	R	Dword	mm
Rx (Cartesian coordinate w.r.t. Robot Base with tool)	04	7455~7456	1D1F~1D20	Float	R	Dword	degree
Ry (Cartesian coordinate w.r.t. Robot Base with tool)	04	7457~7458	1D21~1D22	Float	R	Dword	degree
Rz (Cartesian coordinate w.r.t. Robot Base with tool)	04	7459~7460	1D23~1D24	Float	R	Dword	degree

Table 30: Modbus – Robot Coordinate (When Touch Stop node is triggered)

Note

NOTE:

- When the field of Record Stopping Position on POINT in the touch stop node is not empty, it writes the corresponding coordinate values of the dynamic point to the Modbus addresses.

Run Setting	FC	Address ₁₀	Address ₁₆	Type	R/W	Note
Current Project	04	7701~7799	1E15~1E77	String	R	Use \0 to mark the end of the string.

Change Current Project (Auto Mode only)	06/16	7701~7799	1E15~1E77	String	W	(Auto Mode only)
--	-------	-----------	-----------	--------	---	------------------

Table 31: Modbus – Run Setting



NOTE:

- Users can change the “default” project in Auto Mode via Modbus. Use \0 for reading as the suffix for the ending symbol such as TMflow\0 for the project named TMflow. The \0 denotes 0x00 but not 0x5C 0x30.
- The write command is available only when in Auto Mode and the robot is inactive.

TCP Value	FC	Address ₁₀	Address ₁₆	Type	R/W	Note1	Note2
X (TCP Value)	04	7354~7355	1CBA~1CBB	Float	R	Dword	mm
Y (TCP Value)	04	7356~7357	1CBC~1CBD	Float	R	Dword	mm
Z (TCP Value)	04	7358~7359	1CBE~1CBF	Float	R	Dword	mm
RX (TCP Value)	04	7360~7361	1CC0~1CC1	Float	R	Dword	degree
RY (TCP Value)	04	7362~7363	1CC2~1CC3	Float	R	Dword	degree
RZ (TCP Value)	04	7364~7365	1CC4~1CC5	Float	R	Dword	degree
Mass (TCP Value)	04	7366~7367	1CC6~1CC7	Float	R	Dword	Kg
Ixx (Principal moments of inertia)	04	7368~7369	1CC8~1CC9	Float	R	Dword	
Iyy (Principal moments of inertia)	04	7370~7371	1CCA~1CCB	Float	R	Dword	
Izz (Principal moments of inertia)	04	7372~7373	1CCC~1CCD	Float	R	Dword	
X (Mass center frames with principal axes w.r.t. tool frame)	04	7374~7375	1CCE~1CCF	Float	R	Dword	mm
Y (Mass center frames with principal axes w.r.t. tool frame)	04	7376~7377	1CD0~1CD1	Float	R	Dword	mm
Z (Mass center frames with principal axes w.r.t. tool frame)	04	7378~7379	1CD2~1CD3	Float	R	Dword	mm
RX (Mass center frames with principal axes w.r.t. tool frame)	04	7380~7381	1CD4~1CD5	Float	R	Dword	degree

tool frame)							
RY (Mass center frames with principal axes w.r.t. tool frame)	04	7382~7383	1CD6~1CD7	Float	R	Dword	degree
RZ (Mass center frames with principal axes w.r.t. tool frame)	04	7384~7385	1CD8~1CD9	Float	R	Dword	degree

Table 32: Modbus – TCP Value

Robot Stick	FC	Address ₁₀	Address ₁₆	Type	R/W	Note
Project Running Speed	04	7101	1BBD	Int16	R	%
M/A Mode	04	7102	1BBE	Int16	R	A:1; M:2
Play/Pause	05	7104	1BC0	Bool	W	Triggered as 1 received.
Stop	05	7105	1BC1	Bool	W	
Stick+	05	7106	1BC2	Bool	W	
Stick-	05	7107	1BC3	Bool	W	

Table 33: Modbus – Robot Stick

Project Speed	FC	Address ₁₀	Address ₁₆	Type	R/W	Note
Project Speed	04	7101	1BBD	Int16	R	%
Change Project Speed	03	7101	1BBD	Int16	W	% (Auto Mode only) Project speed can only be written multiples of five. (5≤Project Speed≤100)

Table 34: Modbus - Project Speed

Note

NOTE:

- Play/Pause, Stop, Stick+, Stick- and Change Project Running Speed can only be written in the following situation.
- Stick+, Stick- and Change Project Running Speed can only be written that speed adjustment function is enabled. (Speed Adjustment can refer to "FC: 02, Address 7211")
- Stick +, Stick- and Change Project Running Speed can only be written with external devices, so it cannot be written on the local side [127.0.0.1].

Mode	Client non get control Modbus TCP/RTU	Modbus RTU	Client Get control Modbus TCP
Manual Mode	N/A		Play/Pause Stop Stick+ Stick-
Auto Mode			Play/Pause Stop Stick+ Stick- Change Project Running Speed
In the Auto Remote Mode (Auto Remote Mode can refer to "FC: 02, Address 7209")			Play/Pause Stop Stick+ Stick- Change Project Running Speed

End module button (Pressed)	FC	Address ₁₀	Address ₁₆	Type	R/W	Note
FreeBot	02	7170	1C02	Bool	R	Pressed=1 Release =0

Table 35: Modbut - End Module Button

Stick Status (Pressed)	FC	Address ₁₀	Address ₁₆	Type	R/W	Note
Power Button	02	7150	1BEE	Bool	R	Pressed=1 Release =0
M/A Mode	02	7151	1BEF	Bool	R	
Play/Pause	02	7152	1BF0	Bool	R	
Stop	02	7153	1BF1	Bool	R	
Stick+	02	7154	1BF2	Bool	R	
Stick-	02	7155	1BF3	Bool	R	

Table 36: Modbus – Stick Status (Pressed)

TCP Speed	FC	Address ₁₀	Address ₁₆	Type	R/W	Note1	Note2
X	04	7859~7860	1EB3~1EB4	Float	R	Dword	degree/s
Y	04	7861~7862	1EB5~1EB6	Float	R	Dword	degree/s
Z	04	7863~7864	1EB7~1EB8	Float	R	Dword	degree/s
RX	04	7865~7866	1EB9~1EBA	Float	R	Dword	degree/s
RY	04	7867~7868	1EBB~1EBC	Float	R	Dword	degree/s
RZ	04	7869~7870	1EBD~1EBE	Float	R	Dword	degree/s
TCP Speed	04	7871~7872	1EBF~1EC0	Float	R	Dword	mm/s (According to current tool) $S_{3D} = \sqrt{S_X^2 + S_Y^2 + S_Z^2}$

Table 37: Modbus – TCP Speed

TCP Force	FC	Address ₁₀	Address ₁₆	Type	R/W	Note1	Note2
FX	04	7801~7802	1E79~1E7A	Float	R	Dword	N
FY	04	7803~7804	1E7B~1E7C	Float	R	Dword	N
FZ	04	7805~7806	1E7D~1E7E	Float	R	Dword	N
F3D	04	7807~7808	1E7F~1E80	Float	R	Dword	N

Table 38: Modbus – TCP Force

Joint Torque	FC	Address ₁₀	Address ₁₆	Type	R/W	Note1	Note2
Joint 1	04	7901~7902	1EDD~1EDE	Float	R	Dword	mNm
Joint 2	04	7903~7904	1EDF~1EE0	Float	R	Dword	mNm
Joint 3	04	7905~7906	1EE1~1EE2	Float	R	Dword	mNm
Joint 4	04	7907~7908	1EE3~1EE4	Float	R	Dword	mNm
Joint 5	04	7909~7910	1EE5~1EE6	Float	R	Dword	mNm
Joint 6	04	7911~7912	1EE7~1EE8	Float	R	Dword	mNm

Table 39: Modbus – Joint Torque

Joint Speed	FC	Address ₁₀	Address ₁₆	Type	R/W	Note1	Note2
Joint 1	04	7913~7914	1EE9~1EEA	Float	R	Dword	degree/s
Joint 2	04	7915~7916	1EEB~1EEC	Float	R	Dword	degree/s
Joint 3	04	7917~7918	1EED~1EEE	Float	R	Dword	degree/s
Joint 4	04	7919~7920	1EEF~1EF0	Float	R	Dword	degree/s
Joint 5	04	7921~7922	1EF1~1EF2	Float	R	Dword	degree/s

Joint 6	04	7923~7924	1EF3~1EF4	Float	R	Dword	degree/s
---------	----	-----------	-----------	-------	---	-------	----------

Table 40: Modbus – Joint Speed

Joint Current	FC	Address ₁₀	Address ₁₆	Type	R/W	Note1	Note2
Joint 1	04	7925~7926	1EF5~1EF6	Float	R	Dword	mA
Joint 2	04	7927~7928	1EF7~1EF8	Float	R	Dword	mA
Joint 3	04	7929~7930	1EF9~1EFA	Float	R	Dword	mA
Joint 4	04	7931~7932	1EFB~1EFC	Float	R	Dword	mA
Joint 5	04	7933~7934	1EFD~1EFE	Float	R	Dword	mA
Joint 6	04	7935~7936	1EFF~1F00	Float	R	Dword	mA

Table 41: Modbus – Joint Current

Joint Temperature	FC	Address ₁₀	Address ₁₆	Type	R/W	Note1	Note2
Joint 1	04	7937~7938	1F01~1F02	Float	R	Dword	Celsius
Joint 2	04	7939~7940	1F03~1F04	Float	R	Dword	Celsius
Joint 3	04	7941~7942	1F05~1F06	Float	R	Dword	Celsius
Joint 4	04	7943~7944	1F08~1F08	Float	R	Dword	Celsius
Joint 5	04	7945~7946	1F09~1F0A	Float	R	Dword	Celsius
Joint 6	04	7947~7948	1F0B~1F0C	Float	R	Dword	Celsius

Table 42: Modbus – Joint Temperature

Current Base	FC	Address ₁₀	Address ₁₆	Type	R/W	Note
X	04	8300~8301	206C~206D	Float	R	mm
Y	04	8302~8303	206E~206F	Float	R	mm
Z	04	8304~8305	2070~2071	Float	R	mm
RX	04	8306~8307	2072~2073	Float	R	degree
RY	04	8308~8309	2074~2075	Float	R	degree
RZ	04	8310~8311	2076~2077	Float	R	degree

Table 43: Modbus – Current Base

Safety Stop Criteria	FC	Address ₁₀	Address ₁₆	Type	R/W	Note1	Note2
TCP Speed	04	8001~8002	1F41~1F42	Float	R	Dword	m/sec
TCP Speed under Hand Guide Mode	04	8003~8004	1F43~1F44	Float	R	Dword	m/sec

TCP Force	04	8005~8006	1F45~1F46	Float	R	Dword	N
Joint 1 Speed	04	8007~8008	1F47~1F48	Float	R	Dword	degree/s
Joint 2 Speed	04	8009~8010	1F49~1F4A	Float	R	Dword	degree/s
Joint 3 Speed	04	8011~8012	1F4B~1F4C	Float	R	Dword	degree/s
Joint 4 Speed	04	8013~8014	1F4D~1F4E	Float	R	Dword	degree/s
Joint 5 Speed	04	8015~8016	1F4F~1F50	Float	R	Dword	degree/s
Joint 6 Speed	04	8017~8018	1F51~1F52	Float	R	Dword	degree/s
Joint 1 Torque	04	8019~8020	1F53~1F54	Float	R	Dword	Nm
Joint 2 Torque	04	8021~8022	1F55~1F56	Float	R	Dword	Nm
Joint 3 Torque	04	8023~8024	1F57~1F58	Float	R	Dword	Nm
Joint 4 Torque	04	8025~8026	1F59~1F5A	Float	R	Dword	Nm
Joint 5 Torque	04	8027~8028	1F5B~1F5C	Float	R	Dword	Nm
Joint 6 Torque	04	8029~8030	1F5D~1F5E	Float	R	Dword	Nm
Min Joint 1 Position	04	8031~8032	1F5F~1F60	Float	R	Dword	degree
Max Joint 1 Position	04	8033~8034	1F61~1F62	Float	R	Dword	degree
Min Joint 2 Position	04	8035~8036	1F63~1F64	Float	R	Dword	degree
Max Joint 2 Position	04	8037~8038	1F65~1F66	Float	R	Dword	degree
Min Joint 3 Position	04	8039~8040	1F67~1F68	Float	R	Dword	degree
Max Joint 3 Position	04	8041~8042	1F69~1F6A	Float	R	Dword	degree
Min Joint 4 Position	04	8043~8044	1F6B~1F6C	Float	R	Dword	degree
Max Joint 4 Position	04	8045~8046	1F6D~1F6E	Float	R	Dword	degree
Min Joint 5 Position	04	8047~8048	1F6F~1F70	Float	R	Dword	degree
Max Joint 5 Position	04	8049~8050	1F71~1F72	Float	R	Dword	degree
Min Joint 6 Position	04	8051~8052	1F73~1F74	Float	R	Dword	degree
Max Joint 6 Position	04	8053~8054	1F75~1F76	Float	R	Dword	degree

Table 44: Modbus – Safety Stop Criteria

Collaborative Mode	FC	Address ₁₀	Address ₁₆	Type	R/W	Note1	Note2
TCP Speed	04	8101~8102	1FA5~1FA6	Float	R	Dword	m/sec
TCP Speed under Hand Guide Mode	04	8103~8104	1FA7~1FA8	Float	R	Dword	m/sec
TCP Force	04	8105~8106	1FA9~1FAA	Float	R	Dword	N
Joint 1 Speed	04	8107~8108	1FAB~1FAC	Float	R	Dword	degree/s
Joint 2 Speed	04	8109~8110	1FAD~1FAE	Float	R	Dword	degree/s
Joint 3 Speed	04	8111~8112	1FAF~1FB0	Float	R	Dword	degree/s

Joint 4 Speed	04	8113~8114	1FB1~1FB2	Float	R	Dword	degree/s
Joint 5 Speed	04	8115~8116	1FB3~1FB4	Float	R	Dword	degree/s
Joint 6 Speed	04	8117~8118	1FB5~1FB6	Float	R	Dword	degree/s
Joint 1 Torque	04	8119~8120	1FB7~1FB8	Float	R	Dword	Nm
Joint 2 Torque	04	8121~8122	1FB9~1FBA	Float	R	Dword	Nm
Joint 3 Torque	04	8123~8124	1FBB~1FBC	Float	R	Dword	Nm
Joint 4 Torque	04	8125~8126	1FBD~1FBE	Float	R	Dword	Nm
Joint 5 Torque	04	8127~8128	1FBF~1FC0	Float	R	Dword	Nm
Joint 6 Torque	04	8129~8130	1FC1~1FC2	Float	R	Dword	Nm
Motion Speed	04	8155~8156	1FDB~1FDC	Float	R	Dword	mm/sec
PTP Speed	04	8157~8158	1FDD~1FDE	Float	R	Dword	%
Minimum possible contact area	04	8159~8160	1FDF~1FE0	Float	R	Dword	cm ×cm
GSensor	02	8161	1FE1	Bool	R	Enable: 1 Disable: 0	
Deceleration Time	04	8162	1FE2	Int16	R	ms	

Table 45: Modbus – Collaborative Mode

Running Timer	FC	Address ₁₀	Address ₁₆	Type	R/W	Note
Day	04	8200~8201	2008~2009	Int32	R	Current project running time. (It the project is stopped, it will return to 0.)
Hour	04	8202	200A	Int16	R	
Minute	04	8203	200B	Int16	R	
Second	04	8204	200C	Int16	R	

Table 46: Modbus – Running Timer

Up Time	FC	Address ₁₀	Address ₁₆	Type	R/W	Note
Day	04	8206~8207	200E~200F	Int32	R	Time elapsed since the controller was started
Hour	04	8208	2010	Int16	R	
Minute	04	8209	2011	Int16	R	
Second	04	8210	2012	Int16	R	

Table 47: Modbus – Up Time

Others 1	FC	Address ₁₀	Address ₁₆	Type	R/W	Note
Current Time: Year	04	7301	1C85	Int16	R	
Current Time: Month	04	7302	1C86	Int16	R	

Current Time: Date	04	7303	1C87	Int16	R	
Current Time: Hour	04	7304	1C88	Int16	R	
Current Time: Minute	04	7305	1C89	Int16	R	
Current Time: Second	04	7306	1C8A	Int16	R	
IPC Connect Number	04	7307	1C8B	Int16	R	≤ User Connect Limit
HMI Version	04	7308~7312	1C8C~1C90	String	R	
User Connect Limit	04	7330	1CA2	Int16	R	0: No limit
Modbus Proxy Port	04	7319	1C97	Int16	R	5432
Last Error Code	04	7320~7321	1C98~1C99	Int32	R	Dword
Last Error Time: Year	04	7322	1C9A	Int16	R	
Last Error Time: Month	04	7323	1C9B	Int16	R	
Last Error Time: Date	04	7324	1C9C	Int16	R	
Last Error Time: Hour	04	7325	1C9D	Int16	R	
Last Error Time: Minute	04	7326	1C9E	Int16	R	
Last Error Time: Second	04	7327	1C9F	Int16	R	
Control Box Serial Number	04	7561~7570	1D89~ 1D92	String	R	

Table 48: Modbus – Others 1

Others 2	FC	Address ₁₀	Address ₁₆	Type	R/W	Note1	Note2
Controller Temperature	04	7340~7341	1CAC~1CAD	Float	R	Dword	Celsius
Manipulator Voltage	04	7342~7343	1CAE~1CAF	Float	R	Dword	Voltage
Manipulator Power Consumption	04	7344~7345	1CB0~1CB1	Float	R	Dword	Watt
Manipulator Current	04	7346~7347	1CB2~1CB3	Float	R	Dword	A
Control Box IO Current	04	7348~7349	1CB4~1CB5	Float	R	Dword	mA
End Module IO Current	04	7350~7351	1CB6~1CB7	Float	R	Dword	mA
Sreserve 1	04	7501~7502	1D4D~1D4E	Float	R	Dword	
Sreserve 2	04	7503~7504	1D4F~1D50	Float	R	Dword	
Sreserve 3	04	7505~7506	1D51~1D52	Float	R	Dword	
Sreserve 4	04	7507~7508	1D53~1D54	Float	R	Dword	
Sreserve 5	04	7509~7510	1D55~1D56	Float	R	Dword	
Sreserve 6	04	7511~7512	1D57~1D58	Float	R	Dword	
Sreserve 7	04	7513~7514	1D59~1D5A	Float	R	Dword	
Sreserve 8	04	7515~7516	1D5B~1D5C	Float	R	Dword	

Sreserve 9	04	7517~7518	1D5D~1D5E	Float	R	Dword	
Sreserve 10	04	7519~7520	1D5F~1D60	Float	R	Dword	
Sreserve 11	04	7521~7522	1D61~1D62	Float	R	Dword	
Sreserve 12	04	7523~7524	1D63~1D64	Float	R	Dword	
Sreserve 13	04	7525~7526	1D65~1D66	Float	R	Dword	
Sreserve 14	04	7527~7528	1D67~1D68	Float	R	Dword	
Sreserve 15	04	7529~7530	1D69~1D6A	Float	R	Dword	
Sreserve 16	04	7531~7532	1D6B~1D6C	Float	R	Dword	
Sreserve 17	04	7533~7534	1D6D~1D6E	Float	R	Dword	
Sreserve 18	04	7535~7536	1D6F~1D70	Float	R	Dword	
Sreserve 19	04	7537~7538	1D71~1D72	Float	R	Dword	
Sreserve 20	04	7539~7540	1D73~1D74	Float	R	Dword	
Sreserve 21	04	7541~7542	1D75~1D76	Float	R	Dword	
Sreserve 22	04	7543~7544	1D77~1D78	Float	R	Dword	
Sreserve 23	04	7545~7546	1D79~1D7A	Float	R	Dword	
Sreserve 24	04	7547~7548	1D7B~1D7C	Float	R	Dword	
Sreserve 25	04	7549~7550	1D7D~1D7E	Float	R	Dword	
Sreserve 26	04	7551~7552	1D7F~1D80	Float	R	Dword	
Sreserve 27	04	7553~7554	1D81~1D82	Float	R	Dword	
Sreserve 28	04	7555~7556	1D83~1D84	Float	R	Dword	
Sreserve 29	04	7557~7558	1D85~1D86	Float	R	Dword	
Sreserve 30	04	7559~7560	1D87~1D88	Float	R	Dword	

Table 49: Modbus – Others 2

Others 3	FC	Address ₁₀	Address ₁₆	Type	R/W	Note
Robot Light	04	7332	1CA4	Int16	R	<p>0: Light off, when the emergency stop button is pressed.</p> <p>1: Solid Red, fatal error.</p> <p>2: Flashing Red, Robot is initializing.</p> <p>3: Solid Blue, standby in Auto Mode.</p> <p>4: Flashing Blue, in Auto Mode.</p> <p>5: Solid Green, standby in Manual Mode.</p> <p>6: Flashing Green, in Manual Mode.</p> <p>9: Alternating Blue&Red, Auto Mode error.</p> <p>10: Alternating Green&Red, Manual Mode error.</p> <p>13: Alternating Purple&Green, in Manual Mode (User Connected External Safeguard Input Port for Human - Machine Safety Settings trigger).</p>

						<p>14. Alternating Purple&Blue, in Auto Mode (User Connected External Safeguard Input Port for Human - Machine Safety Settings trigger).</p> <p>17. Alternating White&Green, in Manual Mode & Reduced Space.</p> <p>18. Alternating White&Blue, in Auto Mode & Reduced Space.</p> <p>19. Flashing light blue, representing that it enters the Safe Startup Mode.</p>
--	--	--	--	--	--	---

Table 50: Modbus – Others 3

Others 4	FC	Address ₁₀	Address ₁₆	Type	R/W	Note
User Define Area	01/03/05/06	9000~9999	2328~270F	User-define	R/W	

Table 51: Modbus – Others 4

Appendix B: Display of Indication Light Ring

Users can recognize the operation mode and status of TM Robot from the **Indication Light Ring**. Each light indication is the combination of a maximum 2 different colors. The colors are additionally combined with different ratios of blinking time period to provide additional status information of the robot. There are 2 main categories of light indication: Special Light Indication and Regular Light Indication.

■ Special Light Indication

Initializing: Alternating between Red and Light Off equally

Updating: Alternating between Red and Light Off equally (doubled speed)

Safe Start Up Mode: Alternating between Light Blue and Light Off equally

Fatal Error(Need to re-boot): Solid Red Light (Buzzer emits a long beep)

■ Regular Light Indication

The regular Light Indication is alternating between 2 categories of light indication: Operation Mode Light Indication and Auxiliary Light Indication. The ratio of blinking time period of these 2 light indications indicates different status of the robot. In addition, the display color of Auxiliary Light Indication is prioritized according to the status.

➤ Operation Mode Light Indication

Auto Mode: Blue

Manual Mode: Green

Not in Operation: Light Off

➤ Auxiliary Light Indication (Sort by display priority)

Error: Red

Trip User Connected External Safeguard Input Port for Human - Machine Safety Settings: Purple

Entering Reduced Space: White

Normal: Light Off

➤ Ratio of blinking time period

The table below shows the rule of ratio of blinking time period between Operation Mode Light Color and Auxiliary Light Color.

Status			Blinking Ratio	
			Operation Mode Light Indication	Auxiliary Light Indication
Error			50%	50%
Paused (Trip User Connected External Safeguard Input Port or paused in project)			10%	90%
Not Paused	Project is not running (Incl. Step Run)	Normal	100%	-
		Trip User Connected External Safeguard Input Port for Human - Machine Safety Settings or entering Reduced Space	90%	10%
	Project is running (Incl. Trial Run)		50%	50%

Table 52: Blinking Ratio

The table below shows all combination of Regular Light Indication

Operation mode	Running status	Space/Status of Safety Trigger	Operation Mode Light Indication	Auxiliary Light Indication
Manual Mode	Project is not running (Incl. Step Run) (Manual Control Mode)	Full Speed Space /Normal	Green (100%)	-
		Reduced Space	Green (90%)	White (10%)
		Trip User Connected External Safeguard Input Port for Human - Machine Safety Settings	Green (90%)	Purple (10%)
		Error	Green (50%)	Red (50%)
	Project is running (Manual Trial Run Mode)	Full Speed Space /Normal	Green (50%)	Light Off (50%)
		Reduced Space	Green (50%)	White (50%)
		Trip User Connected External Safeguard Input Port for Human - Machine Safety Settings	Green (50%)	Purple (50%)
		Error	Green (50%)	Red (50%)

Operation mode	Running status	Space/Status of Safety Trigger	Operation Mode Light Indication	Auxiliary Light Indication
	Paused (Trip User Connected External Safeguard Input Port Port or paused in Trial Run)	Full Speed Space /Normal	Green (10%)	Light Off (90%)
		Reduced Space	Green (10%)	White (90%)
		Trip User Connected External Safeguard Input Port for Human - Machine Safety Settings	Green (10%)	Purple (90%)
		Error	Green (50%)	Red (50%)
Auto Mode	Project is not running	Full Speed Space /Normal	Blue (100%)	-
		Reduced Space	Blue (90%)	White (10%)
		Trip User Connected External Safeguard Input Port for Human - Machine Safety Settings	Blue (90%)	Purple (10%)
		Error	Blue (50%)	Red (50%)
	Project is running	Full Speed Space /Normal	Blue (50%)	Light Off (50%)
		Reduced Space	Blue (50%)	White (50%)
		Trip User Connected External Safeguard Input Port for Human - Machine Safety Settings	Blue (50%)	Purple (50%)
		Error	Blue (50%)	Red (50%)
	Paused (Trip User Connected External Safeguard Input Port or paused in project)	Full Speed Space /Normal	Blue (10%)	Light Off (90%)
		Reduced Space	Blue (10%)	White (90%)
		Trip User Connected External Safeguard Input Port for Human - Machine Safety Settings	Blue (10%)	Purple (90%)
		Error	Blue (50%)	Red (50%)

Table 53: Light Indications

The color of Entering Reduced Space is Purple in the software version prior to 1.68.6800

The table below is a quick reference of how to recover from different kinds of error/ status.

Color/Blinking	Description	Troubleshooting
Alternating between Green/Red light (with 2 beeps from buzzer)	Manual Mode Error	Press the FREE Button in the End Module or the Stop Button on Robot Stick to troubleshoot the error.
Alternating between Blue/Red light (with 2 beeps from buzzer)	Auto Mode Error	After switching to Manual Mode, press the FREE Button in the End Module or the Stop Button on Robot Stick to troubleshoot.
Light blue light	Safe Start up Mode	Press Stop Button for 3 seconds to return to original Mode
Flashing red light	Robot is initializing.	Not Applicable
Light off	Emergency stop pressed	Release the Emergency Switch to turn to Safe Start up Mode
Light off Buzzer emits a long beep	Category 0 stop	Shutdown and Restart required
Solid red light Buzzer emits a long beep	Fatal error	Shutdown and Restart required

Table 54: Quick References of Color/Blinking

Appendix C: Tables of Safety Parameter Upper and Lower Bounds

TM5-700/ TM5M-700

		Default Value	Min. Value	Max. Value	Unit	
Performance Safety Settings	TCP Speed	1.5	0	4.5	m/sec	
	TCP Force	150	0	450	N	
	Hand Guide TCP Speed Limit	1.5	0	4.5	m/sec	
	Joint Speed	J1	190	0	190	deg/sec
		J2	190	0	190	deg/sec
		J3	190	0	190	deg/sec
		J4	235	0	235	deg/sec
		J5	235	0	235	deg/sec
		J6	235	0	235	deg/sec
	Joint Torque	J1	65	0	170	Nm
		J2	65	0	170	Nm
		J3	65	0	170	Nm
		J4	15	0	45	Nm
J5		15	0	45	Nm	
J6		15	0	45	Nm	
Human-Machine Safety Settings	TCP Speed	Vary from the Body Region selected.	0	1.5	m/sec	
	TCP Force		0	450	N	
	Hand Guide TCP Speed Limit	Default, Min. and Max. Values are the same as Performance Safety Setting.				
	Joint Speed	J1-J6				
	Joint Torque	J1	65	0	170	Nm
		J2	65	0	170	Nm
		J3	65	0	170	Nm
		J4	15	0	45	Nm
J5		15	0	45	Nm	
J6		15	0	45	Nm	
Reduce Time		150	150	800	ms	
	Joint Position	J1	-	-270	270	deg
		J2	-	-180	180	deg
		J3	-	-155	155	deg
		J4	-	-180	180	deg
		J5	-	-180	180	deg
		J6	-	-270	270	deg
	Cartesian Limit A/B	X	-	-3000	3000	mm
		Y	-	-3000	3000	mm
		Z	-	-3000	3000	mm
		θ_z	-	0	359	deg
R		-	60	3000	mm	

Table 55: Safety Parameter Table - TM5-700/ TM5M-700

		Default Value	Min. Value	Max. Value	Unit	
Performance Safety Settings	TCP Speed	1.5	0	4.5	m/sec	
	TCP Force	150	0	450	N	
	Hand Guide TCP Speed Limit	1.5	0	4.5	m/sec	
	Joint Speed	J1	190	0	190	deg/sec
		J2	190	0	190	deg/sec
		J3	190	0	190	deg/sec
		J4	235	0	235	deg/sec
		J5	235	0	235	deg/sec
		J6	235	0	235	deg/sec
	Joint Torque	J1	65	0	170	Nm
		J2	65	0	170	Nm
		J3	65	0	170	Nm
		J4	15	0	45	Nm
J5		15	0	45	Nm	
J6		15	0	45	Nm	
Human-Machine Safety Settings	TCP Speed	Vary from the Body Region selected.	0	1.5	m/sec	
	TCP Force		0	450	N	
	Hand Guide TCP Speed Limit	Default, Min. and Max. Values are the same as Performance Safety Setting.				
	Joint Speed	J1-J6				
	Joint Torque	J1	65	0	170	Nm
		J2	65	0	170	Nm
		J3	65	0	170	Nm
		J4	15	0	45	Nm
J5		15	0	45	Nm	
J6		15	0	45	Nm	
Reduce Time		150	150	800	ms	
	Joint Position	J1	-	-360	360	deg
		J2	-	-360	360	deg
		J3	-	-155	155	deg
		J4	-	-360	360	deg
		J5	-	-360	360	deg
		J6	-	-360	360	deg
	Cartesian Limit A/B	X	-	-3000	3000	mm
		Y	-	-3000	3000	mm
		Z	-	-3000	3000	mm
		θ_z	-	0	359	deg
		R	-	60	3000	mm

Table 56: Safety Parameter Table - TM5X-700

		Default Value	Min. Value	Max. Value	Unit	
Performance Safety Settings	TCP Speed	1.5	0	4.5	m/sec	
	TCP Force	150	0	450	N	
	Hand Guide TCP Speed Limit	1.5	0	4.5	m/sec	
	Joint Speed	J1	190	0	190	deg/sec
		J2	190	0	190	deg/sec
		J3	190	0	190	deg/sec
		J4	235	0	235	deg/sec
		J5	235	0	235	deg/sec
		J6	235	0	235	deg/sec
	Joint Torque	J1	65	0	170	Nm
		J2	65	0	170	Nm
		J3	65	0	170	Nm
J4		15	0	45	Nm	
J5		15	0	45	Nm	
J6		15	0	45	Nm	
Human-Machine Safety Settings	TCP Speed	Vary from the Body Region selected.	0	1.5	m/sec	
	TCP Force		0	450	N	
	Hand Guide TCP Speed Limit	Default, Min. and Max. Values are the same as Performance Safety Setting.				
	Joint Speed	J1-J6				
	Joint Torque	J1	65	0	170	Nm
		J2	65	0	170	Nm
		J3	65	0	170	Nm
		J4	15	0	45	Nm
J5		15	0	45	Nm	
J6		15	0	45	Nm	
Reduce Time		150	150	800	ms	
	Joint Position	J1	-	-270	270	deg
		J2	-	-180	180	deg
		J3	-	-155	155	deg
		J4	-	-180	180	deg
		J5	-	-180	180	deg
		J6	-	-270	270	deg
	Cartesian Limit A/B	X	-	-3000	3000	mm
		Y	-	-3000	3000	mm
		Z	-	-3000	3000	mm
		θ_z	-	0	359	deg
		R	-	60	3000	mm

Table 57: Safety Parameter Table - TM5-900/ TM5M-900

		Default Value	Min. Value	Max. Value	Unit	
Performance Safety Settings	TCP Speed	1.5	0	4.5	m/sec	
	TCP Force	150	0	450	N	
	Hand Guide TCP Speed Limit	1.5	0	4.5	m/sec	
	Joint Speed	J1	190	0	190	deg/sec
		J2	190	0	190	deg/sec
		J3	190	0	190	deg/sec
		J4	235	0	235	deg/sec
		J5	235	0	235	deg/sec
		J6	235	0	235	deg/sec
	Joint Torque	J1	65	0	170	Nm
		J2	65	0	170	Nm
		J3	65	0	170	Nm
		J4	15	0	45	Nm
J5		15	0	45	Nm	
J6		15	0	45	Nm	
Human-Machine Safety Settings	TCP Speed	Vary from the Body Region selected.	0	1.5	m/sec	
	TCP Force		0	450	N	
	Hand Guide TCP Speed Limit	Default, Min. and Max. Values are the same as Performance Safety Setting.				
	Joint Speed	J1-J6				
	Joint Torque	J1	65	0	170	Nm
		J2	65	0	170	Nm
		J3	65	0	170	Nm
		J4	15	0	45	Nm
J5		15	0	45	Nm	
J6		15	0	45	Nm	
Reduce Time		150	150	800	ms	
	Joint Position	J1	-	-360	360	deg
		J2	-	-360	360	deg
		J3	-	-155	155	deg
		J4	-	-360	360	deg
		J5	-	-360	360	deg
		J6	-	-360	360	deg
	Cartesian Limit A/B	X	-	-3000	3000	mm
		Y	-	-3000	3000	mm
		Z	-	-3000	3000	mm
		θ_z	-	0	359	deg
R		-	60	3000	mm	

Table 58: Safety Parameter Table - TM5X-900

		Default Value	Min. Value	Max. Value	Unit	
Performance Safety Settings	TCP Speed	1.5	0	4.5	m/sec	
	TCP Force	150	0	450	N	
	Hand Guide TCP Speed Limit	1.5	0	4.5	m/sec	
	Joint Speed	J1	130	0	130	deg/sec
		J2	130	0	130	deg/sec
		J3	190	0	190	deg/sec
		J4	160	0	160	deg/sec
		J5	160	0	160	deg/sec
		J6	190	0	190	deg/sec
	Joint Torque	J1	120	0	350	Nm
		J2	120	0	350	Nm
		J3	65	0	170	Nm
		J4	15	0	45	Nm
J5		15	0	45	Nm	
J6		15	0	45	Nm	
Human-Machine Safety Settings	TCP Speed	Vary from the Body Region selected.	0	1.5	m/sec	
	TCP Force		0	450	N	
	Hand Guide TCP Speed Limit	Default, Min. and Max. Values are the same as Performance Safety Setting.				
	Joint Speed	J1-J6				
	Joint Torque	J1	65	0	350	Nm
		J2	65	0	350	Nm
		J3	65	0	170	Nm
		J4	15	0	45	Nm
		J5	15	0	45	Nm
		J6	15	0	45	Nm
Reduce Time	300	300	800	ms		
	Joint Position	J1	-	-270	270	deg
		J2	-	-180	180	deg
		J3	-	-163	163	deg
		J4	-	-180	180	deg
		J5	-	-180	180	deg
		J6	-	-270	270	deg
	Cartesian Limit A/B	X	-	-3000	3000	mm
		Y	-	-3000	3000	mm
		Z	-	-3000	3000	mm
		θ_z	-	0	359	deg
		R	-	60	3000	mm

Table 59: Safety Parameter Table - TM14/ TM14M

		Default Value	Min. Value	Max. Value	Unit	
Performance Safety Settings	TCP Speed	1.5	0	4.5	m/sec	
	TCP Force	150	0	450	N	
	Hand Guide TCP Speed Limit	1.5	0	4.5	m/sec	
	Joint Speed	J1	130	0	130	deg/sec
		J2	130	0	130	deg/sec
		J3	190	0	190	deg/sec
		J4	160	0	160	deg/sec
		J5	160	0	160	deg/sec
		J6	190	0	190	deg/sec
	Joint Torque	J1	120	0	350	Nm
		J2	120	0	350	Nm
		J3	65	0	170	Nm
J4		15	0	45	Nm	
J5		15	0	45	Nm	
J6		15	0	45	Nm	
Human-Machine Safety Settings	TCP Speed	Vary from the Body Region selected.	0	1.5	m/sec	
	TCP Force		0	450	N	
	Hand Guide TCP Speed Limit	Default, Min. and Max. Values are the same as Performance Safety Setting.				
	Joint Speed	J1-J6				
	Joint Torque	J1	65	0	350	Nm
		J2	65	0	350	Nm
		J3	65	0	170	Nm
		J4	15	0	45	Nm
J5		15	0	45	Nm	
J6		15	0	45	Nm	
Reduce Time		300	300	800	ms	
	Joint Position	J1	-	-360	360	deg
		J2	-	-360	360	deg
		J3	-	-163	163	deg
		J4	-	-360	360	deg
		J5	-	-360	360	deg
		J6	-	-360	360	deg
	Cartesian Limit A/B	X	-	-3000	3000	mm
		Y	-	-3000	3000	mm
		Z	-	-3000	3000	mm
		θ_z	-	0	359	deg
R		-	60	3000	mm	

Table 60: Safety Parameter Table - TM14X

		Default Value	Min. Value	Max. Value	Unit	
Performance Safety Settings	TCP Speed	1.5	0	4.5	m/sec	
	TCP Force	150	0	450	N	
	Hand Guide TCP Speed Limit	1.5	0	4.5	m/sec	
	Joint Speed	J1	130	0	130	deg/sec
		J2	130	0	130	deg/sec
		J3	190	0	190	deg/sec
		J4	190	0	190	deg/sec
		J5	190	0	190	deg/sec
		J6	190	0	190	deg/sec
	Joint Torque	J1	120	0	350	Nm
		J2	120	0	350	Nm
		J3	65	0	170	Nm
		J4	15	0	45	Nm
J5		15	0	45	Nm	
J6		15	0	45	Nm	
Human-Machine Safety Settings	TCP Speed	Vary from the Body Region selected.	0	1.5	m/sec	
	TCP Force		0	450	N	
	Hand Guide TCP Speed Limit	Default, Min. and Max. Values are the same as Performance Safety Setting.				
	Joint Speed	J1-J6				
	Joint Torque	J1	65	0	350	Nm
		J2	65	0	350	Nm
		J3	65	0	170	Nm
		J4	15	0	45	Nm
		J5	15	0	45	Nm
		J6	15	0	45	Nm
Reduce Time	300	300	800	ms		
	Joint Position	J1	-	-270	270	deg
		J2	-	-180	180	deg
		J3	-	-166	166	deg
		J4	-	-180	180	deg
		J5	-	-180	180	deg
		J6	-	-270	270	deg
	Cartesian Limit A/B	X	-	-3000	3000	mm
		Y	-	-3000	3000	mm
		Z	-	-3000	3000	mm
		θ_z	-	0	359	deg
		R	-	60	3000	mm

Table 61: Safety Parameter Table - TM12/ TM12M

		Default Value	Min. Value	Max. Value	Unit	
Performance Safety Settings	TCP Speed	1.5	0	4.5	m/sec	
	TCP Force	150	0	450	N	
	Hand Guide TCP Speed Limit	1.5	0	4.5	m/sec	
	Joint Speed	J1	130	0	130	deg/sec
		J2	130	0	130	deg/sec
		J3	190	0	190	deg/sec
		J4	190	0	190	deg/sec
		J5	190	0	190	deg/sec
		J6	190	0	190	deg/sec
	Joint Torque	J1	120	0	350	Nm
		J2	120	0	350	Nm
		J3	65	0	170	Nm
		J4	15	0	45	Nm
J5		15	0	45	Nm	
J6		15	0	45	Nm	
Human-Machine Safety Settings	TCP Speed	Vary from the Body Region selected.	0	1.5	m/sec	
	TCP Force		0	450	N	
	Hand Guide TCP Speed Limit	Default, Min. and Max. Values are the same as Performance Safety Setting.				
	Joint Speed	J1-J6				
	Joint Torque	J1	65	0	350	Nm
		J2	65	0	350	Nm
		J3	65	0	170	Nm
		J4	15	0	45	Nm
J5		15	0	45	Nm	
J6		15	0	45	Nm	
Reduce Time		300	300	800	ms	
	Joint Position	J1	-	-360	360	deg
		J2	-	-360	360	deg
		J3	-	-166	166	deg
		J4	-	-360	360	deg
		J5	-	-360	360	deg
		J6	-	-360	360	deg
	Cartesian Limit A/B	X	-	-3000	3000	mm
		Y	-	-3000	3000	mm
		Z	-	-3000	3000	mm
		θ_z	-	0	359	deg
R		-	60	3000	mm	

Table 62: Safety Parameter Table - TM12X

Appendix D: Ethernet Slave Data Table

Item Name (ID)	Description	Type	Size	*A	**W	Note
Robot_Error	Error or Not	bool	1	R		Yes:1 No: 0
Project_Run	Project Running or Not	bool	1	R		Yes:1 No: 0
Project_Edit	Project Editing or Not	bool	1	R		Yes:1 No: 0
Project_Pause	Project Pause or Not	bool	1	R		Yes:1 No: 0
Get_Control	Get Control or Not	bool	1	R		Yes:1 No: 0
Safeguard_A	Safety IO (Safeguard Port A trigger)	bool	1	R		Triggered: 1 Restored: 0
ESTOP	Emergency Stop	bool	1	R		Triggered: 1 Restored: 0
Camera_Light	Light	byte	1	R/W		Enable: 1 Disable: 0
Robot_Model	Robot Model	string	1	R		
Error_Code	Last Error Code	int	1	R		Format: Hexadecimal
Error_Time	Last Error Time	string	1	R		Format: [YYYY]-[MM]-[DD]T[hh]:[mm]:[ss.sss]
Coord_Base_Flange	Cartesian coordinate w.r.t. current Base without tool	float	6	R		Unit: mm
Joint_Angle	Joint 1 angle - Joint 6 angle	float	6	R		Unit: degree
Coord_Base_Tool	Cartesian coordinate w.r.t. current Base with tool	float	6	R		Unit: mm
Coord_Robot_Flange	Cartesian coordinate w.r.t. Robot Base without tool	float	6	R		Unit: mm
Coord_Robot_Tool	Cartesian coordinate w.r.t. Robot Base with tool	float	6	R		Unit: mm
Touch_Coord_Base_Flange	Cartesian coordinate w.r.t. current Base without tool (When touchstop node be triggered)	float	6	R		Unit: mm
Touch_Joint_Angle_Stop	Joint 1 angle - Joint 6 angle (When touchstop node be triggered)	float	6	R		Unit: degree
Touch_Coord_Base_Tool	Cartesian coordinate w.r.t. current Base with tool (When touchstop node be triggered)	float	6	R		Unit: mm

Item Name (ID)	Description	Type	Size	*A	**W	Note
Touch_Coord_Robot_Flange	Cartesian coordinate w.r.t. Robot Base without tool (When touchstop node be triggered)	float	6	R		Unit: mm
Touch_Coord_Robot_Tool	Cartesian coordinate w.r.t. Robot Base with tool (When touchstop node be triggered)	float	6	R		Unit: mm
TCP_Force	Tool Force FX,FY,FZ	float	3	R		Unit: N
TCP_Force3D	Tool Force FX,FY,FZ 3D	float	1	R		Unit: N
TCP_Speed	Tool Speed X,Y,Z,RX,RY,RZ	float	6	R		Unit: mm/s, deg/s
TCP_Speed3D	Tool Speed X,Y,Z 3D	float	1	R		Unit: mm/s
Joint_Speed	Joint Speed	float	6	R		Unit: deg/s
Joint_Torque	Joint Torque 1 - 6	float	6	R		Unit: mNm
TCP_Name	TCP Name	string	1	R		
TCP_Value	TCP Value	float	6	R		Unit: mm
TCP_Mass	Mass (TCP Value)	float	1	R		Unit: kg
TCP_MOI	Ixx, Iyy, Izz (Principal moments of inertia)	float	3	R		
TCP_MCF	Mass center frames with principal axes w.r.t. tool frame	float	6	R		Unit: mm
Base_Name	Base Name	string	1	R		
Base_Value	Base Value	float	6	R		Unit: mm
HandCamera_Value	HandCamera TCP Value	float	6	R		Unit: mm
Project_Name	Project Name	string	1	R/W	A	
Project_Speed	Project Running Speed	int	1	R		Unit: %
MA_Mode	M/A Mode	int	1	R		None:0, A:1; M:2
Stick_PlayPause	Play/Pause Button	bool	1	R/W		Triggered as 1 received
Stick_Stop	Stop Button	bool	1	R/W		Triggered as 1 received
Stick_Plus	Stick+ Button	bool	1	R/W		Triggered as 1 received
Stick_Minus	Stick- Button	bool	1	R/W		Triggered as 1 received

Item Name (ID)	Description	Type	Size	*A	**W	Note
Safety_TCP_Speed	Safety Setting: Non-Collaborative Stop Criteria: TCP Speed	float	1	R		Unit: m/s
Safety_TCP_Speed_Hand Guide	Safety Setting: Non-Collaborative Stop Criteria: TCP Speed under hand guide mode	float	1	R		Unit: m/s
Safety_TCP_Force	Safety Setting: Non-Collaborative Stop Criteria: TCP Force	float	1	R		Unit: N
Safety_Joint_Speed	Safety Setting: Non-Collaborative Stop Criteria: Joint 1 - Joint 6 Speed	float	6	R		Unit: deg/sec
Safety_Joint_Torque	Safety Setting: Non-Collaborative Stop Criteria: Joint 1 - Joint 6 Torque	float	6	R		Unit: Nm
Safety_Joint_Angle_Min	Safety Setting: Non-Collaborative Stop Criteria: Min Joint 1 -Joint 6 angle	float	6	R		Unit: degree
Safety_Joint_Angle_Max	Safety Setting: Non-Collaborative Stop Criteria: Max Joint 1 -Joint 6 angle	float	6	R		Unit: degree
Col_TCP_Speed	Safety Setting: Collaborative Stop Criteria: TCP Speed	float	1	R		Unit: m/s
Col_TCP_Speed_HandGuide	Safety Setting: Collaborative Stop Criteria: TCP Speed under hand guide mode	float	1	R		Unit: m/s
Col_TCP_Force	Safety Setting: Collaborative Stop Criteria: TCP Force	float	1	R		Unit: N
Col_Joint_Speed	Safety Setting: Collaborative Stop Criteria: Joint 1 - Joint 6 Speed	float	6	R		Unit: deg/sec
Col_Joint_Torque	Safety Setting: Collaborative Stop Criteria: Joint 1 - Joint 6 Torque	float	6	R		Unit: Nm

Item Name (ID)	Description	Type	Size	*A	**W	Note
Col_Motion_Speed	Safety Setting: Collaborative Speed: Motion Speed	float	1	R		Unit: mm/s
Col_PTP_Speed	Safety Setting: Collaborative Speed: PTP Speed	float	1	R		Unit: %
Col_Deceleration_Time	Safety Setting: Collaborative Deceleration Time	int	1	R		Unit: ms
Col_Contact_Area	Safety Setting: Collaborative Minimum possible contact area	float	1	R		Unit: cm x cm
Safety_GSensor	Safety Setting: Enable G-Sensor	bool	1	R		Yes:1 No: 0
ControlBox_SN	Serial Number of Control Box	string	1	R		
Controller_Temperature	Controller Temperature	float	1	R		Unit: Celsius
Manipulator_Voltage	Voltage consumed by robot arm	float	1	R		Unit: Voltage
Manipulator_Consumption	Power consumed by robot arm	float	1	R		Unit: Watt
Manipulator_Current	Current consumed by robot arm	float	1	R		Unit: Ampere
ControlBox_IO_Current	Total Current output of Controlbox IO Ports	float	1	R		Unit: mA
End_IO_Current	Total Current output of End Module IO Ports	float	1	R		Unit: mA
Current_Time	Current Time	string	1	R		Format: [YYYY]-[MM]-[DD]T[hh]:[mm]:[ss.sss]
TMflow_Version	TMflow Version	string	1	R		Format: X.XX.XXXX
DHTable	DHTable { theta1, alpha1, a1, d1, joint_type1, lower_bound1, upper_bound1; theta2, alpha2, , upper_bound6 } forms a 7x6 matrix	float	42	R		Unit: mm deg joint_type: always 0

Item Name (ID)	Description	Type	Size	*A	**W	Note
DeltaDH	DeltaDH Format: { d_theta1, d_alpha1, d_a1, d_d1, d_beta1; d_theta2, d_alpha2, , d_beta6 } forms a 5x6 matrix	float	30	R		Unit: mm deg d_XXX: delta value of relative item in DHTable. d_beta: delta value of rotation angle at y axis of relative joint coordinate.
Robot_Light	Robot Light	int	1	R		0: Light off, when the emergency stop button is pressed. 1: Solid Red, fatal error. 2: Flashing Red, Robot is initializing. 3: Solid Blue, standby in Auto Mode. 4: Flashing Blue, in Auto Mode. 5: Solid Green, standby in Manual Mode. 6: Flashing Green, in Manual Mode. 9: Alternating Blue&Red, Auto Mode error. 10: Alternating Green&Red, Manual Mode error. 13: Alternating Purple&Green, in Manual Mode (Safeguard Port B trigger). 14: Alternating Purple&Blue, in Auto Mode (Safeguard Port B trigger). 17: Alternating White&Green, in Manual Mode & Reduced Space. 18: Alternating White&Blue, in Auto Mode & Reduced Space. 19: Flashing light blue, representing that it enters the Safe Startup Mode.
Ctrl_DO?	Digital Output #?	byte	1	R/W		High:1 Low:0
Ctrl_DI?	Digital Output #?	byte	1	R		High:1 Low:0
Ctrl_AO?	Analog Output #?	byte	1	R/W		Unit: Voltage
Ctrl_AI?	Analog Output #?	byte	1	R		Unit: Voltage
End_DO?	Digital Output #?	byte	1	R/W		High:1 Low:0

Item Name (ID)	Description	Type	Size	*A	**W	Note
End_DI?	Digital Output #?	byte	1	R		High:1 Low:0
End_AO?	Analog Output #?	byte	1	R/W		Unit: Voltage
End_AI?	Analog Output #?	byte	1	R		Unit: Voltage
Ext?_DO	External Module #? Digital Output	byte	128	R/W		High:1 Low:0
Ext?_DO_Mask	External Module #? Digital Output Mask	byte	128	R/W		High:Set Value Low:Ignore
Ext?_DI	External Module #? Digital input	byte	128	R		High:1 Low:0
Ext?_AO	External Module #? Analog Output	byte	128	R/W		Unit: Voltage
Ext?_AO_Mask	External Module #? Analog Output Mask	byte	128	R/W		High: Set Value Low:Ignore
Ext?_AI	External Module #? Analog input	byte	128	R		Unit: Voltage

*Accessibility

**Writable Mode

Table 63: Ethernet Slave Data Table

Appendix E: PROFINET Data Table

Robot to Master Device

TM_1_T2O_RobotInfo (48 bytes)

Item Name	Starting Byte	Size	Data Type	Note
ControlBoxID	0	16 bytes	string	
RobotModel	16	16 bytes	string	
HMIVersion	32	16 bytes	string	

TM_2_T2O_SystemAndError (64bytes)

Item Name	Starting Byte	Size	Data Type	Note
Error_Code	48	4 bytes	byte[4]	
Error_Time_YY	52	4 bytes	int32	
Error_Time_MM	56	1 byte	byte	
Error_Time_DD	57	1 byte	byte	
Error_Time_hh	58	1byte	byte	
Error_Time_mm	59	1 byte	byte	
Error_Time_ss	60	1 byte	byte	
RobotLink	61	1 byte	byte	
System_Temperature	62	4 bytes	float	
System_Voltage	66	4 bytes	float	
System_Consumption	70	4 bytes	float	
System_Current	74	4 bytes	float	
Control_Current	78	4 bytes	float	
End_Current	82	4 bytes	float	
Current_Time_YY	86	4 bytes	int32	
Current_Time_MM	90	1 byte	byte	
Current_Time_DD	91	1 byte	byte	
Current_Time_hh	92	1 byte	byte	
Current_Time_mm	93	1 byte	byte	
Current_Time_ss	94	1 byte	byte	
RemoteCount	95	1 byte	byte	
SystemAndError_Reserved	96	16 bytes	Reserved	

TM_3_T2O_RunSetting (80 bytes)

Item Name	Starting Byte	Size	Data Type	Note
AutoRun_ProjectName	112	64 bytes	string	
Project_Status	176	1 byte	byte	(bit0:isError,1:isPlay,2:isEdit,3:isPause,4:isPermission,5:SafetyIO(GuardA),6:E-Stop,7:RunSetting_Reserved)
RobotLight	177	1 byte	byte	

StickSpeed	178	1 byte	byte	
StickStatus	179	1 byte	byte	(bit0:PlayPause,1:Stop,2:Plus,3:Minus)
ManualAuto	180	1 byte	byte	
CameraLight	181	1 byte	byte	
RunSetting_Reserved	182	10 bytes	Reserved	

TM_4_T20_TCP (68 bytes)

Item Name	Starting Byte	Size	Data Type	Note
Current_TCP_Value	192	24 bytes	float[6]	
Current_TCP_Mass	216	4 bytes	float	
Current_TCP_MOI	220	12 bytes	float[3]	
Current_TCP_MCF	232	24 bytes	float[6]	
TCP_Reserved	256	4 bytes	Reserved	

TM_5_T20_Coordinate (168 bytes)

Item Name	Starting Byte	Size	Data Type	Note
Current_Base_Value	260	24 bytes	float[6]	
Coord_Joint	284	24 bytes	float[6]	
Coord_CurrBase_Tool	308	24 bytes	float[6]	
Coord_RobotBase_Tool	332	24 bytes	float[6]	
Coordinate_Reserved	356	72 bytes	Reserved	

TM_6_T20_TCPForce (88 bytes)

Item Name	Starting Byte	Size	Data Type	Note
TCP_Force	428	12 bytes	float[3]	
TCP_Force3D	440	4 bytes	float	
TCP_Speed3D	444	4 bytes	float	
Joint_Torque	448	24 bytes	float[6]	
TCPForce_Reserved	472	44 bytes	Reserved	

TM_7_T20_IO (24 bytes)

Item Name	Starting Byte	Size	Data Type	Note
CtrlBox_DI	516	2 bytes	byte[2]	
CtrlBox_DO	518	2 bytes	byte[2]	
CtrlBox_AI	520	8 bytes	float[2]	
CtrlBox_AO	528	4 bytes	float	
EndModule_DI	532	1 byte	byte	
EndModule_DO	533	1 byte	byte	
EndModule_AI	534	4 bytes	float	
IO_Reserved	538	2 bytes	Reserved	

TM_8_T2O_RegisterBit (16 bytes)

Item Name	Starting Byte	Size	Data Type	Note
Register_Bit	540	16 bytes	byte[16]	

TM_9_T2O_RegisterInt (120 bytes)

Item Name	Starting Byte	Size	Data Type	Note
Register_Int	556	120 bytes	int32[30]	

TM_10_T2O_RegisterFloat (120 bytes)

Item Name	Starting Byte	Size	Data Type	Note
Register_Float	676	120 bytes	float[30]	

TM_11_T2O_SystemReserved1 (64 bytes)

Item Name	Starting Byte	Size	Data Type	Note
SystemReserved1	796	64 bytes	byte[64]	

TM_12_T2O_SystemReserved2 (64 bytes)

Item Name	Starting Byte	Size	Data Type	Note
SystemReserved2	860	64 bytes	byte[64]	

End 924

Master Device to Robot**TM_1_O2T_RunSetting** (132 bytes)

Item Name	Starting Byte	Size	Data Type	Note
StickStatus	0	1 byte	byte	(bit0:PlayPause, 1:Stop, 2:Plus, 3:Minus) *Refer to safety manual for detail.
CameraLightMask	1	1 byte	byte	
CameraLight	2	1 byte	byte	
AutoRun_ProjectName_Mask	3	1 byte	byte	
AutoRun_ProjectName	4	64 bytes	string	*Auto Mode Only
RunSetting_Reserved	68	64 bytes	Reserved	

TM_2_O2T_IO (16 bytes)

Item Name	Starting Byte	Size	Data Type	Note
CtrlBox_DO_Mask	132	2 bytes	byte[2]	
CtrlBox_DO	134	2 bytes	byte[2]	
EndModule_DO_Mask	136	1 byte	byte	
EndModule_DO	137	1 byte	byte	
CtrlBox_AO_Mask	138	1 byte	byte	

IO_Reserved1	139	1 byte	byte	
CtrlBox_AO	140	4 bytes	float	
IO_Reserved2	144	4 bytes	Reserved	

TM_3_O2T_RegisterBit (16 bytes)

Item Name	Starting Byte	Size	Data Type	Note
Register_Bit	148	16 bytes	byte[16]	

TM_4_O2T_RegisterInt (120 bytes)

Item Name	Starting Byte	Size	Data Type	Note
Register_Int	164	120 bytes	int[30]	

TM_5_O2T_RegisterFloat (120 bytes)

Item Name	Starting Byte	Size	Data Type	Note
Register_Float	284	120 bytes	float[30]	

TM_6_O2T_SystemReserved1 (64 bytes)

Item Name	Starting Byte	Size	Data Type	Note
SystemReserved1	404	64 bytes	byte[64]	

TM_7_O2T_SystemReserved2 (64 bytes)

Item Name	Starting Byte	Size	Data Type	Note
SystemReserved2	468	64 bytes	byte[64]	

End 532

Appendix F: Error Descriptions and Suggestions

ErrorDescription00000000	No Alarm
ErrorDescription00000001	Inverse Kinematics Failure, Working Range Issue
ErrorDescription00000005	Stop Motion Command
ErrorDescription00000009	Robot Controller Function Library Issue
ErrorDescription0000000A	Cartesian Space Move Failure From Robot Base Space
ErrorDescription00000010	Tool Connected Failure With Robot
ErrorDescription00000011	Inverse Kinematics Failure, Motion Blending Issue
ErrorDescription00000012	Inverse Kinematics Failure, Interpolation Points Issue
ErrorDescription00000013	PTP function Failure in Driver
ErrorDescription00000014	Over Range Between the Interpolation Points
ErrorDescription00000015	Create Circle Path Failed
ErrorDescription00000016	Motion Failure due to Max Points Counts Issue in the NURBS
ErrorDescription00000017	Forward Kinematics Failure, Interpolation Points Issue
ErrorDescription00000018	Inverse Jacobian Matrices Failure jacobian
ErrorDescription00000019	Timeout in Steady State Error in Motion Process.
ErrorDescription0000001A	Motion Failure when Moving at Constant Speed
ErrorDescription00000021	Velocity or Angular Velocity Over Range
ErrorDescription00000022	Force or Torque Over Range
ErrorDescription00000023	Both Alarm in Error(HEX)21 and Error(HEX)22
ErrorDescription00000024	Shock Alarm in the Robot
ErrorDescription0000002D	Joint Signature mismatch with vendor
ErrorDescription0000002E	gear ratio is not match the model
ErrorDescription0000002F	Pose error by g-sensor g sensor
ErrorDescription00000030	Over Current in the Power Supply 24V, I/O Board Alarm
ErrorDescription00000031	Safety function initialized failure
ErrorDescription00000032	Disconnect with safety monitor module
ErrorDescription00000033	TCP Speed over the criterion on the manual mode
ErrorDescription00000035	Joint Drivers Alarm
ErrorDescription0000003B	The Joint Numbers of the Robot does not match the Default Setting
ErrorDescription0000003C	This Model is not supported
ErrorDescription0000003E	the 48V power NG on the ESM-PreOP mode
ErrorDescription00000040	Joint ESI does not match the Default Setting
ErrorDescription00000041	Failed to execute SDO command
ErrorDescription00000042	Failed to read Manufacturer ID

ErrorDescription00000043	Failed to initialize EtherCAT
ErrorDescription00000044	Failed to turn into DC SYNC in the EtherCAT Loop
ErrorDescription00000045	Joint in the boot mode is waiting for flash the firmware.
ErrorDescription00000048	the 48V power NG on the ESM-OP mode
ErrorDescription00000049	Power supply 48V failure
ErrorDescription0000004B	The Slave Numbers does not Match the Default Numbers
ErrorDescription0000004C	Failed to Access EEPROM Data in the Power Board
ErrorDescription0000004D	Failed to Access Live Data
ErrorDescription0000004E	The S/N of the Joints does not match the default setting
ErrorDescription0000004F	Power Board is Missing
ErrorDescription00000050	Power Board Lost Connection
ErrorDescription00000051	Power Board Over Heat
ErrorDescription00000052	“Robot performed Cat.1 stop.”
ErrorDescription00000053	The Current or Voltage in the 48V Power Supply is out of range
ErrorDescription00000054	The Current is still out of range under current limit constrain
ErrorDescription00000055	The Current is out of range in the 24V Power Supply
ErrorDescription00000056	I/O Board Lost Connection
ErrorDescription00000057	Joints Lost Connection
ErrorDescription00000058	HMI Lost Connection with Robot Controller
ErrorDescription00000059	System Reset
ErrorDescription0000005A	System Shut Down
ErrorDescription0000005B	Motion Stopped by Robot Stick key
ErrorDescription0000005C	Buzzer Failure in the Robot Stick Key
ErrorDescription0000005D	EtherCAT Loop Lost Connection EtherCAT 斷線
ErrorDescription0000005E	An alarm occurs in the Safety Monitor Board
ErrorDescription0000005F	An Alarm is triggered by Input Pin in the Safety Monitor Board
ErrorDescription00000060	The Motion Command Executed with manual mode at the same time
ErrorDescription00000061	The Motion Command Executed with Compliance Mode at the same time
ErrorDescription00000062	The Pose of the Robot is closer to the singularity in the manual mode
ErrorDescription0000006A	It is a test command to disconnect with safety monitor board
ErrorDescription0000006F	3D Viewer Lost Connection
ErrorDescription00000070	Vision Servoing Failure
ErrorDescription00000072	The Pose of the Robot Over the Position or Close to the Singularity during Vision Servoing Process
ErrorDescription00000073	Alarms occurred in Data Flow in Vision Servoing
ErrorDescription00000074	Operation Mode Switching Failure occurred in the Joint Drivers during Vision Servoing
ErrorDescription00000075	Vision Servoing failed to get image

ErrorDescription00000076	There is an Alarm in Blending Process in the Vision Servoing Block
ErrorDescription00000080	TmSync : Group Members Over Specification
ErrorDescription00000081	TmSync : Group Members Alarm
ErrorDescription00000082	TmSync : Group Members Lost Connection
ErrorDescription00000083	TmSync : Robot Lost connection
ErrorDescription00000084	TmSync : Robot ID Conflict In The Group
ErrorDescription00000085	TmSync : MacID Conflict In The Group
ErrorDescription00000086	TmSync : Enable networking with specified NIC Failure
ErrorDescription00000090	Process Line Motion Failure
ErrorDescription000000A0	[Error][Safety Function]Violate Encoder Standstill when no motion is allowed.
ErrorDescription000000A1	[Error][Safety Function]Violate Encoder Standstill when error occurred.
ErrorDescription000000A2	[Error][Safety Function]Violate Encoder Standstill when Safeguard Port A triggered
ErrorDescription000000A3	[Error][Safety Function]Violate Encoder Standstill when no motion is allowed.
ErrorDescription000000A4	[Error][Safety Function]Violate Encoder Standstill in stop area
ErrorDescription000000A6	[Error][Safety Function] Discrepancy was detected between dual channels Internal Protective Output.
ErrorDescription000000A7	[Error][Safety Function] Discrepancy was detected between dual channels Encoder Standstill Output.
ErrorDescription000000A8	[Warning][External Device] Discrepancy was detected between dual channels of Emergency Stop Port.
ErrorDescription000000A9	[Warning][External Device] Discrepancy was detected between dual channels of Safeguard Port A.
ErrorDescription000000AA	[Warning][External Device] Discrepancy was detected between dual channels of Safeguard Port B.
ErrorDescription000000AB	[Warning][External Device] Discrepancy was detected between dual channels of Enabling Device Ports.
ErrorDescription000000AD	[Error][Safety Function] Discrepancy was detected between dual channels of Emergency Stop Output.
ErrorDescription000000AE	[Error][Safety Function] Discrepancy was detected between dual channels of Safeguard Port A Output.
ErrorDescription000000AF	[Error][Safety Function] Discrepancy was detected between dual channels of Safeguard Port B Output.
ErrorDescription000000B0	HMI SerialPort COM Lost Connection with Robot Controller
ErrorDescription000000F0	HIM Command to shout down the robot system
ErrorDescription00008000	[Warning][External Device] Discrepancy was detected between dual channels of Emergency Stop Port.
ErrorDescription00008001	[Warning][External Device] Discrepancy was detected between dual channels of Emergency Stop Port.
ErrorDescription00008002	[Warning][External Device] Discrepancy was detected between dual channels of Safeguard Port A.
ErrorDescription00008003	[Warning][External Device] Discrepancy was detected between dual channels of Safeguard Port B.
ErrorDescription00008004	[Warning][External Device] Discrepancy was detected between dual channels of Enabling Device Ports.
ErrorDescription00008005	[Warning][External Device] Discrepancy was detected between dual channels of System Emergency Stop Ports.
ErrorDescription00008006	[Warning][External Device] Discrepancy was detected between dual channels of Safeguard Port.
ErrorDescription00008007	[Warning][External Device] Discrepancy was detected between dual channels of Safeguard Port.
ErrorDescription00008008	[Error][Safety Function] Discrepancy was detected between dual channels of Emergency Stop Output.
ErrorDescription00008009	[Error][Safety Function] Discrepancy was detected between dual channels of Safeguard Port A Output.
ErrorDescription0000800A	[Error][Safety Function] Discrepancy was detected between dual channels of Safeguard Port B Output.

ErrorDescription0000800B	[Error][Safety Function] Discrepancy was detected between dual channels Internal Protective Output.
ErrorDescription0000800C	[Error][Safety Function] Discrepancy was detected between dual channels Encoder Standstill Output.
ErrorDescription0000FF00	Self-Collision
ErrorDescription0000FF01	[Error][Safety Function]Momentum exceeds limit
ErrorDescription0000FF02	[Error][Safety Function]Power exceeds limit
ErrorDescription0000FF03	Collaboration Area
ErrorDescription0000FF04	[Error][Safety Function]TCP speed exceeds limit
ErrorDescription0000FF05	[Error][Safety Function]TCP force exceeds limit
ErrorDescription0000FF06	[Error][Safety Function]J1 Position exceeds limit
ErrorDescription0000FF07	[Error][Safety Function]J1 Velocity exceeds limit
ErrorDescription0000FF08	[Error][Safety Function]J1 Torque exceeds limit
ErrorDescription0000FF09	[Error][Safety Function]J2 Position exceeds limit
ErrorDescription0000FF0A	[Error][Safety Function]J2 Velocity exceeds limit
ErrorDescription0000FF0B	[Error][Safety Function]J2 Torque exceeds limit
ErrorDescription0000FF0C	[Error][Safety Function]J3 Position exceeds limit
ErrorDescription0000FF0D	[Error][Safety Function]J3 Velocity exceeds limit
ErrorDescription0000FF0E	[Error][Safety Function]J3 Torque exceeds limit
ErrorDescription0000FF0F	[Error][Safety Function]J4 Position exceeds limit
ErrorDescription0000FF10	[Error][Safety Function]J4 Velocity exceeds limit
ErrorDescription0000FF11	[Error][Safety Function]J4 Torque exceeds limit
ErrorDescription0000FF12	[Error][Safety Function]J5 Position exceeds limit
ErrorDescription0000FF13	[Error][Safety Function]J5 Velocity exceeds limit
ErrorDescription0000FF14	[Error][Safety Function]J5 Torque exceeds limit
ErrorDescription0000FF15	[Error][Safety Function]J6 Position exceeds limit
ErrorDescription0000FF16	[Error][Safety Function]J6 Velocity exceeds limit
ErrorDescription0000FF17	[Error][Safety Function]J6 Torque exceeds limit
ErrorDescription0000FF18	J7 Position exceeds limit
ErrorDescription0000FF19	J7 Velocity exceeds limit
ErrorDescription0000FF1A	J7 Torque exceeds limit
ErrorDescription0000FF20	[Error][Hardware]Solenoid current is NG
ErrorDescription0000FF21	[Error][Hardware]Joint movement range is NG in brake release status
ErrorDescription0000FFA0	[Error][Hardware]The voltage on DCBUS is too low (40V)
ErrorDescription0000FFA1	[Error][Hardware]The voltage on DCBUS is too high (60V)
ErrorDescription0000FFA2	The acceleration on X direction of G sensor is out of range
ErrorDescription0000FFA3	The acceleration on Y direction of G sensor is out of range
ErrorDescription0000FFA4	The acceleration on Z direction of G sensor is out of range

ErrorDescription0000FFA5	[Error][Hardware]The temperature on PCB is too high (90 degree Celsius)
ErrorDescription0000FFA6	[Error][Hardware]The current in U phase of motor is too high
ErrorDescription0000FFA7	[Error][Hardware]The current in V phase of motor is too high
ErrorDescription0000FFA8	[Error][Hardware]The current in W phase of motor is too high
ErrorDescription0000FFA9	The overcurrent is protected by current sensor of U phase
ErrorDescription0000FFAA	The overcurrent is protected by current sensor of V phase
ErrorDescription0000FFAB	[Error][Hardware]The protection is on for motor hold
ErrorDescription0000FFAC	The initial angle of three phase of motor is not correct
ErrorDescription0000FFAD	The index angle of encoder is not calibrated
ErrorDescription0000FFAE	[Error][Hardware]Overcurrent in DCBUS
ErrorDescription0000FFAF	[Error][System]The communication of EtherCAT is timeout
ErrorDescription0000FFB1	[Error][System]The communication of SPI is timeout
ErrorDescription0000FFB2	Illegal interrupt to MCU
ErrorDescription0000FFB3	The watch dog of MCU is timeout
ErrorDescription0000FFB4	The initialization of joint coordinate is timeout
ErrorDescription0000FFB5	FW version doesn't match HW version
ErrorDescription0000FFB6	The process in main loop is timeout
ErrorDescription0000FFB7	Brake release failed.
ErrorDescription0000FFB8	[Error][Hardware]Gate Driver NG
ErrorDescription0000FFB9	[Error][Hardware]MOFSET NG
ErrorDescription0000FFBA	[Error][Hardware]Current Sensor NG
ErrorDescription0000FFC0	The deviation is too high when initializing joint coordinate
ErrorDescription0000FFC1	Runin process R2: Z index miss
ErrorDescription0000FFC2	Runin process R2: multi Z index happened
ErrorDescription0000FFC3	Runin process R2: U signal NG
ErrorDescription0000FFC4	Runin process R2: V signal NG
ErrorDescription0000FFC5	Runin process R2: W signal NG
ErrorDescription0000FFC6	Runin process R2: the sequence of UVW is NG
ErrorDescription0000FFC7	Runin process R2: AB signal is NG
ErrorDescription0000FFC8	Failure in loading data from EEPROM
ErrorDescription0000FFC9	The electrical angle of motor is not correct (warning)
ErrorDescription0000FFCA	[Error][Hardware]Multi Z index happened in encoder output
ErrorDescription0000FFCB	The deviation between command and current position is too high
ErrorDescription0000FFCC	[Error][Hardware]The Z index signal is missing
ErrorDescription0000FFCD	[Error][Hardware]Encoder connection failed
ErrorDescription0000FFCE	[Error][Hardware]The compensation of encoder signal is too high

ErrorDescription0000FFCF	[Error][Hardware]The protection is on for motor hold (type 2)
ErrorDescription0000FFD0	The UVW signal of encoder is NG
ErrorDescription0000FFD1	[Error][Hardware]The data is abnormal when reading magnetic encoder.
ErrorDescription0000FFD2	[Error][Hardware]The magnet is NG judged by magnetic encoder
ErrorDescription0000FFD3	[Error][Hardware]The origin of joint module is out of preset
ErrorDescription0000FFD4	The data in EEPROM is dislocated
ErrorDescription0000FFD5	The parameters for joint module are abnormal
ErrorDescription0000FFD6	The process of I2C control flow is out of control
ErrorDescription0000FFD7	Runin process R2: index calibration failed
ErrorDescription0000FFD8	[Hardware][Error]The resistance of UVW of motor is abnormal
ErrorDescription0000FFD9	[Hardware][Error]The connection sequence of UVW of motor is not correct
ErrorDescription0000FFDA	Runin process R2: the current in UVW phase is NG
ErrorDescription0000FFDB	Runin process R4: UVW calibration result is out of limit
ErrorDescription0000FFDC	Runin process : G sensor calibration result is out of limit
ErrorDescription0000FFDD	An error occurs when command changes the control mode.
ErrorDescription0000FFDE	Changing EtherCAT ESM when PDS is in OP mode
ErrorDescription0000FFDF	Unknown EtherCAT ESM command
ErrorDescription0000FFE0	[Hardware][Error]The voltage of DC bus is low in EtherCAT OP mode
ErrorDescription0000FFE1	Online multiturn calibration failed
ErrorDescription0000FFE2	The magnetic encoder data is not stable in the position initialization process
ErrorDescription0000FFE3	The joint angle between "power on" and "position initialization" exceeds limit
ErrorDescription0000FFE4	[Error][System]The position initialization process is timeout ("Z search" is not finished)
ErrorDescription0000FFE5	The position initialization process is timeout
ErrorDescription0000FFE6	The result is NG in position initialization process
ErrorDescription0000FFE7	Runin process: the process of g sensor calibration is NG
ErrorDescription0000FFE8	[Hardware][Error]The output of g sensor is NG
ErrorDescription0000FFE9	The check sum result from EEPROM data is abnormal
ErrorDescription0000FFEA	[Hardware][Error]The voltage of 5V is NG
ErrorDescription0000FFEB	[Hardware][Error]The voltage of 12V is NG
ErrorDescription0000FFEC	The ADC compensation is out of limit
ErrorDescription0000FFED	[Error][Hardware]The compensation of encoder signal is too high in ABS mode
ErrorDescription0000FFEE	The deviation is too high between latching index and position initialization process
ErrorDescription0000FFEF	The parameters of magnetic encoder are abnormal
ErrorDescription00013880	Illegal dimension of a matrix or vector
ErrorDescription00013881	At least one element of a matrix or vector is with illegal index
ErrorDescription00013882	Illegal rotation matrix

ErrorDescription00013883	Illegal homogeneous transformation
ErrorDescription00013884	Illegal skew matrix
ErrorDescription00013885	Illegal square matrix
ErrorDescription00013886	Matrix inverse failed
ErrorDescription00013887	Illegal norm value
ErrorDescription00013888	Householder transformation failed
ErrorDescription00013889	Eigen value calculation failed
ErrorDescription0001388A	Illegal number of Eigen values
ErrorDescription0001388B	Matrix is singular
ErrorDescription0001388C	Illegal upper/lower triangular matrix
ErrorDescription0001388D	Elementary matrix operation failed
ErrorDescription0001388E	Gaussian Elimination failed
ErrorDescription0001388F	Null space does not exist
ErrorDescription00013890	QR decomposition failed
ErrorDescription00013891	QR iteration diverged
ErrorDescription00013892	Circle path center calculation failed
ErrorDescription00013893	Circle path planning initialization failed
ErrorDescription00013894	Kalman gain calculation failed
ErrorDescription00013895	Kalman filter initialization need to be done
ErrorDescription00013896	Illegal index to get/set a component of a matrix/vector
ErrorDescription00013897	Illegal size/format of function input variables
ErrorDescription00013898	Illegal size/format of function returned variables
ErrorDescription00013899	Solve $A \sin(x) + B \cos(x) = C$ failed
ErrorDescription0001389A	Solve $AX = XB$ failed
ErrorDescription0001389B	Effective data is not enough
ErrorDescription0001389C	Specific axis are parallel
ErrorDescription0001389D	Solve $A = XBY$ failed
ErrorDescription0001389E	No initial guessing matrix
ErrorDescription0001389F	Transform type mismatch
ErrorDescription000138A0	Illegal dimension of a quaternion
ErrorDescription000138A1	Illegal string format of a quaternion
ErrorDescription000138A2	Quaternion setting failed
ErrorDescription000138A3	Quaternion transfer to angle-axis failed
ErrorDescription000138A4	Failed to get rotation vector via quaternion
ErrorDescription000138A5	Failed to solve sub-block Eigen value
ErrorDescription00013C68	End effector data file does not yet been loaded

ErrorDescription00013C69	The end effector has existed already
ErrorDescription00013C6A	At least one end effector should be selected for your task
ErrorDescription00013C6B	Illegal end effector data format
ErrorDescription00013C6C	Illegal end effector serial number
ErrorDescription00013C6D	This end effector is not on our list
ErrorDescription00013C6E	End effector should be connected
ErrorDescription00013C6F	End effector should be disconnected
ErrorDescription00013C70	Setting end effector parameters to robot object failed
ErrorDescription00013C71	End effector parameters acquisition from end effector object failed
ErrorDescription00013C72	End effector connection with robot failed
ErrorDescription00013C73	End effector has connected with robot
ErrorDescription00013C74	End effector reconnection with robot failed
ErrorDescription00013C75	End effector data lost
ErrorDescription00014050	Illegal DOF of robot
ErrorDescription00014051	The total number of robot parameters is illegal
ErrorDescription00014052	Illegal DOF of generalized Cartesian position, velocity, or acceleration
ErrorDescription00014053	Illegal DOF of joint position, velocity, or acceleration
ErrorDescription00014054	Joint type mismatch
ErrorDescription00014055	Illegal link frame SN
ErrorDescription00014056	Forward kinematics calculation failed
ErrorDescription00014057	Illegal robot configuration (dimension or content)
ErrorDescription00014058	Inverse kinematics calculation failed
ErrorDescription00014059	Illegal Robot ID
ErrorDescription0001405A	At least one joint position is not in its working range
ErrorDescription0001405B	This function supports only robots with 6 DOF or above
ErrorDescription0001405C	Robot status update failed
ErrorDescription0001405D	Load robot configure file failed
ErrorDescription0001405E	Save robot configure file failed
ErrorDescription0001405F	Illegal robot configuration number
ErrorDescription00014060	This function is dummy, just used for override
ErrorDescription00014061	Jacobian calculation failed
ErrorDescription00014062	Jacobian inverse failed
ErrorDescription00014063	Speed transfer via Jacobian failed
ErrorDescription00014064	Robot is at singular point
ErrorDescription00014065	Differential orientation transfer failed
ErrorDescription00014066	The transfer between geometric and analytical Jacobian failed

ErrorDescription00014067	Forward dynamics computation failed
ErrorDescription00014068	Inertia tensor computation failed
ErrorDescription00014069	Inverse dynamics computation failed
ErrorDescription0001406A	Robot dynamic parameter ID matrix computation failed
ErrorDescription0001406B	End effector dynamic parameter ID matrix computation failed
ErrorDescription0001406C	ID parameter format can not be formed
ErrorDescription0001406D	Cartesian/Joint space trajectory transfer failed
ErrorDescription0001406E	Acquiring equivalent axis-angle rotation matrix between two frames failed
ErrorDescription0001406F	Task/object frame establishing failed
ErrorDescription00014070	TCP calibration process initialization failed
ErrorDescription00014071	TCP calibration process initialization has done
ErrorDescription00014072	Illegal number of changing robot postures for TCP calibration
ErrorDescription00014073	TCP calibration process initialization has not done yet
ErrorDescription00014074	Record Robot posture failed in TCP calibration
ErrorDescription00014075	TCP computation failed
ErrorDescription00014076	Task frame establishing process initialization has not yet been done
ErrorDescription00014077	Task frame establishing calculation failed
ErrorDescription00014078	At least one of Position, Px, or Py is not recorded in task frame establishing process
ErrorDescription00014079	Linking task frame failed
ErrorDescription0001407A	Illegal number of task parameters
ErrorDescription0001407B	Task space coordinates transfer failed : from RTX to HMI
ErrorDescription0001407C	Task space coordinates transfer failed : from HMI to RTX
ErrorDescription0001407D	teach point transfer on task space failed
ErrorDescription0001407E	Target approaching failed
ErrorDescription0001407F	Move to target with respect to tool base failed
ErrorDescription00014080	Move to target with respect to base failed
ErrorDescription00014081	DH compensation failed
ErrorDescription00014082	DH compensation stops, this will not affect robot moving
ErrorDescription00014083	Move distance with respect to base frame failed
ErrorDescription00014084	Robot flipping failed
ErrorDescription00014085	Failed to check whether robot can flip
ErrorDescription00014086	IK solution jumping
ErrorDescription00014087	Inner workspace limit
ErrorDescription00014088	Outer workspace limit
ErrorDescription00014089	Wrist singularity
ErrorDescription0001408A	Out of outer workspace

ErrorDescription0001408B	Out of inner workspace
ErrorDescription0001408C	Infinite solution. No solution is selected
ErrorDescription0001408D	Undefined error
ErrorDescription0001408E	Homing check failed
ErrorDescription0001408F	Modify IK solution failed
ErrorDescription00014090	At least one joint position will reach boundary
ErrorDescription00014091	Check robot configuration failed
ErrorDescription000140AA	Set robot parameter from string failed
ErrorDescription000140AB	Acquiring robot flange generalized position failed
ErrorDescription000140AC	Acquiring robot tool generalized position failed
ErrorDescription000140AD	Series frames transform failed
ErrorDescription000140AE	Failed to calculate Jacobian due to DH error
ErrorDescription000140AF	Generalized Cartesian position transfer between frames failed
ErrorDescription000140B0	Load delta DH file failed
ErrorDescription000140B1	At least one joint position is not in the range , -180 deg~ 180 deg
ErrorDescription00014438	Illegal DOF of eye in hand transform
ErrorDescription00014439	Initialization of EIH calibration process failed
ErrorDescription0001443A	Initialization of EIH calibration process has not yet been done
ErrorDescription0001443B	Obtaining initial posture 'P0' failed in EIH calibration
ErrorDescription0001443C	Moving to next posture 'Pi' failed in EIH calibration
ErrorDescription0001443D	Data pattern processing failed in SCARA's EIH calibration
ErrorDescription0001443E	Forward/Inverse indexing of data pattern processing failed in SCARA's EIH calibration
ErrorDescription0001443F	EIH transform calculation failed
ErrorDescription00014440	Camera is attached with the translational axis, and it does not move
ErrorDescription00014441	Camera does not move, but image changes
ErrorDescription00014442	Current image data is invalid
ErrorDescription00014443	Initialization of camera intrinsic parameter calibration process failed
ErrorDescription00014444	There are constraints on the effective robot moving area, please change the initial robot posture or the virtual radius
ErrorDescription00014445	Initialization of camera intrinsic parameter calibration process failed
ErrorDescription00014446	Initialization of camera intrinsic parameter calibration process has not yet been done
ErrorDescription00014447	Get current robot Cartesian posture failed
ErrorDescription00014448	Change tool parameters failed
ErrorDescription00014449	Change robot tip's orientation failed
ErrorDescription0001444A	Visual move01 failed
ErrorDescription0001444B	Visual move11 failed

ErrorDescription0001444C	Visual move02 failed
ErrorDescription0001444D	EIH calibration should be done first
ErrorDescription0001444E	Inverse the interaction matrix failed
ErrorDescription0001444F	Visual move03 failed
ErrorDescription00014450	Visual move04 failed
ErrorDescription00014451	Visual move05 failed
ErrorDescription00014452	Visual move15 failed
ErrorDescription00014453	Visual move06 failed
ErrorDescription00014454	Visual move07 failed
ErrorDescription00014455	Visual move17 failed
ErrorDescription00014456	Illegal number of taking image data
ErrorDescription00014457	The link frame attached with EIH camera does not match user's definition
ErrorDescription00014458	Record each robot and camera posture in EIH calibration failed
ErrorDescription00014459	Illegal camera extrinsic parameter matrix
ErrorDescription0001445A	Illegal number of changing robot posture
ErrorDescription0001445B	Rotate around Y axis failed
ErrorDescription0001445C	Move along X axis failed
ErrorDescription0001445D	Rotate around Z axis failed
ErrorDescription0001445E	Get EIH transform failed
ErrorDescription0001445F	Set EIH transform failed
ErrorDescription00014820	Move camera to target failed
ErrorDescription00014C08	Feature point coordinates transfer (robot base frame to image frame) failed
ErrorDescription00014C09	Feature point coordinates transfer (robot base frame to camera frame) failed
ErrorDescription00014C0A	Establishing interaction matrix of a single image point failed
ErrorDescription00014C0B	The working depth on optic axis can not be zero
ErrorDescription00014C0C	The camera focus can not be zero
ErrorDescription00014C0D	Acquiring joint velocity command failed
ErrorDescription00014C0E	Illegal number of feature points
ErrorDescription00014C0F	Illegal number of image errors
ErrorDescription00014C10	The DOF of image point must be 2
ErrorDescription00014C11	Camera should be attached with flange/tool frame
ErrorDescription00014C12	The visual servo damping factor should be positive
ErrorDescription00014C13	Acquiring joint velocity command (via two feature points) failed
ErrorDescription00014C14	Visual servo simulation test failed
ErrorDescription00014FF0	Initialization of DH calibration process failed
ErrorDescription00014FF1	Initialization of DH calibration process has not yet been done

ErrorDescription00014FF2	Record Robot posture failed in DH calibration
ErrorDescription00014FF3	Transfer between frame 0 and (i-1) failed
ErrorDescription00014FF4	Transfer between frame i and N failed
ErrorDescription00014FF5	Transfer between frame 0 and i failed
ErrorDescription00014FF6	DH calibration calculation (for SCARA type robot) failed
ErrorDescription00014FF7	DH calibration calculation (for 6DOF type robot) failed
ErrorDescription00014FF8	Calculate DH compensation terms failed
ErrorDescription00014FF9	DH compensation failed
ErrorDescription00014FFA	DH calibration moving guided by vision failed
ErrorDescription00014FFB	TCP calibration move failed
ErrorDescription00014FFC	DH align error over 0.3 mm
ErrorDescription00014FFD	Error on joint 1-5 over 1 degree!
ErrorDescription000153D8	Acquiring parallel list position failed
ErrorDescription000153D9	In parallel list application, at least two points coincides
ErrorDescription000153DA	Parallel list number should be large than 1 in one dimension
ErrorDescription000153DB	Align the x-y plane of tool frame with that of base frame failed
ErrorDescription000153DC	Illegal geometric plane data
ErrorDescription000153DD	Align the x-y plane of tool frame with that of user defined frame failed
ErrorDescription000153DE	Align the x-y plane of tool frame with that of task frame failed
ErrorDescription000153DF	Acquiring object avoidance point failed
ErrorDescription000153E0	The robot configuration does not match that used in vision system
ErrorDescription000153E1	Acquiring robot's joint position corresponding to its flange's generalized Cartesian position failed
ErrorDescription000153E2	Calculating the generalized Cartesian force acting on robot's TCP failed
ErrorDescription000153E3	Calculating the effective norm of the generalized Cartesian force acting on robot's TCP failed
ErrorDescription000157C0	Right arm failed
ErrorDescription000157C1	Left arm failed
ErrorDescription00020000	[Error][Hardware]Camera NOT found
ErrorDescription00020001	Camera in use
ErrorDescription00020002	Unexpected error
ErrorDescription00020003	[Error][Hardware]Camera is disconnected. Please check whether the connection of camera is broken or the USB slots are overloaded.
ErrorDescription00020004	Unmatched job version. The job was made by PreAPR version but current Vision is APR version
ErrorDescription00020005	[Warning][User Setting]Missing Dongle Key: ...
ErrorDescription00020006	Grab image failed
ErrorDescription00020007	Vision error
ErrorDescription00020008	[Error][Vision]Job NOT found

ErrorDescription00020009	[Error][Vision>Actioner is busy
ErrorDescription0002000A	This job can only be run on X64 platform
ErrorDescription0002000B	Servoing and Vision-IO threads conflict
ErrorDescription00030001	[Error][User Setting]Invalid plane points
ErrorDescription00030002	[Error][User Setting]Invalid cube points
ErrorDescription00030003	[Error][User Setting]Failed to build operation space with the new plane
ErrorDescription00030004	[Error][User Setting]Failed to build operation space with the new stop plane
ErrorDescription00030005	Invalid selected planes
ErrorDescription00030006	Incorrect command format
ErrorDescription00030007	Detection point is out of safety space
ErrorDescription00031000	[Error][System]Can not connect to Viewer
ErrorDescription00031001	Send data to Viewer failed
ErrorDescription00031002	Receive data from Viewer failed
ErrorDescription00031003	Get invalid data from Viewer
ErrorDescription00031004	Get no data from Viewer
ErrorDescription00031005	Invalid Point
ErrorDescription00031006	Invalid Parameter
ErrorDescription00031007	Over angle limit
ErrorDescription00040000	Client is not connected to any proxy server
ErrorDescription00040001	Undefined error code
ErrorDescription00040002	HMI server error
ErrorDescription00040003	Robot is unlocked
ErrorDescription00040004	Undefined Signal
ErrorDescription00040005	[Error][Flow]Program Exception
ErrorDescription00040006	Write SystemFile.ini failed
ErrorDescription00040007	[Hardware][Error]Robot is not connected
ErrorDescription00040008	Illegal Privilege
ErrorDescription00040009	Log In/Out failed
ErrorDescription0004000A	[info.]Robot is locked
ErrorDescription0004000B	Set System Time failed
ErrorDescription0004000C	Set TCP failed
ErrorDescription0004000D	File Transfer failed
ErrorDescription0004000E	Under FreeBot
ErrorDescription0004000F	[Error][Software>Delete project failed
ErrorDescription00040010	Generate file error
ErrorDescription00040011	[Error][Motion]Step run failed

ErrorDescription00040012	Changed base failed
ErrorDescription00040013	[Error][Motion]Change TCP failed
ErrorDescription00040014	[Error][System]Generate Prog File failed
ErrorDescription00040015	[Warning][Hardware]Fan rpm less than 1000
ErrorDescription00040016	[User Setting][Error]Invalid Parameter
ErrorDescription00040017	Base Not Found
ErrorDescription00040018	[Error][Software]Base is in use
ErrorDescription00040019	Point Not Found
ErrorDescription0004001A	Operation Space Binding failed
ErrorDescription0004001B	Set Component List failed
ErrorDescription0004001C	[Error][Flow]Start Node Not Connected
ErrorDescription0004001D	Failed to re-record the point to another base
ErrorDescription0004001E	[Error][User Setting]User number over limit
ErrorDescription0004001F	[Error][User Setting]Ownership has been acquired
ErrorDescription00040020	Only can owner delete ownership
ErrorDescription00040021	[Error][Software]New Base failed
ErrorDescription00040022	[Error][User Setting]Compliance teach failed
ErrorDescription00040023	[Error][User Setting]Line teach failed
ErrorDescription00040024	Internal Error
ErrorDescription00040025	Incorrect Control Mode
ErrorDescription00040026	Robot Cmd failed
ErrorDescription00040027	[Error][External Device]USB Error
ErrorDescription00040028	Project Is Running
ErrorDescription00040029	Project Is Editing
ErrorDescription0004002A	[Error][Flow]Project does not exist
ErrorDescription0004002B	[System][Error]Project File Load Error
ErrorDescription0004002C	[System][Error]Project Compile failed
ErrorDescription0004002D	[Error][System]Project Run failed
ErrorDescription0004002E	[info.][System]Project Locked
ErrorDescription0004002F	[info.]Connected to a new Proxy Server
ErrorDescription00040030	Force-Torque sensor is not found
ErrorDescription00040031	[Error][External Device]Force-Torque sensor open failed
ErrorDescription00040032	Set Modbus Device failed
ErrorDescription00040033	Delete Modbus Device failed
ErrorDescription00040034	Force-Torque sensor data is not updated
ErrorDescription00040035	[Error][External Device]Force-Torque sensor data does not response

ErrorDescription00040036	[info.]Point Type is Offline
ErrorDescription00040037	[Error][System]Set watch node failed
ErrorDescription00040038	[Error]Node is in offline mode
ErrorDescription00040039	Base name is not accepted
ErrorDescription0004003A	[Error][User Setting]Over maximum loading
ErrorDescription0004003B	[Error][User Setting]Over maximum loading with TCP loading
ErrorDescription0004003C	NotActive
ErrorDescription0004003D	SendDataFail
ErrorDescription0004003E	ReceiveDataFail
ErrorDescription0004003F	InvalidReturnValue
ErrorDescription00040040	GetNoDataFromEmulator
ErrorDescription00040041	CheckOptimalSpeed
ErrorDescription00040042	Move Pose for F/T Sensor error
ErrorDescription00040043	Compute Tool Mass and Centroid for F/T Sensor error
ErrorDescription00040044	Save Tool to F/T Sensor error
ErrorDescription00040045	Step run failed because of variables parameter
ErrorDescription00040046	Out of Cartesian limits set. Please check if the TCP or elbow is out of the Cartesian limits
ErrorDescription00040047	Robot TCP and/or elbow exceeds Cartesian limit
ErrorDescription00040048	This project has existed, could not create new project
ErrorDescription00040100	Certification does not match Please download the latest certification file from website to start the installation process. The installation process will not proceed.
ErrorDescription00040101	Certification does not match Please request the certification file from the product provider, and put it under TMflow folder located under the installation directory to enable TMflow Editor. Program will be terminated automatically.
ErrorDescription00040102	[Warning][User Setting]Host and client versions conflict [Cause]The software version between the robot (host) and Tmflow.exe (client) is not matched [Caution]Check both versions of the robot (host) and the Tmflow.exe on PC (client) if they are matched or not [Precaution] If the versions are not matched, there would be possibly to trigger unexpected errors for certain functions [Solution]Click OK to close the pop up window Make sure both versions of the robot (host) and the Tmflow.exe on PC (client) are matched before login
ErrorDescription00040103	[Error][User Setting]Certification does not match. Please get the certification file from the product provider, and put it under TMflow folder located under the installation directory to enable TMflow Editor. Program will be closed automatically.

	[Cause]Certification for the corresponding HMI does not match
	[Caution]1. Check if the certification file on Techman folder is the correct version if this happens on Tmflow.exe 2. Check if the certification file on the USB drive exists or if it is the correct version for HMI update
	[Solution]1. Click OK to close the pop up window 2. Replace the file with the correct one Make sure the certification file is correct
ErrorDescription00040104	MD5 file is not existed.
ErrorDescription00040105	MD5 is not matched, the file may be damaged.
ErrorDescription00040F80	ProxyServer initialize failure
ErrorDescription00040F81	ProxyServer initialize failure, TcpListener error
ErrorDescription00040F82	ProxyServer initialize failure, ServerParams error
ErrorDescription00040F83	ProxyServer initialize failure, ConfigData error
ErrorDescription00040F84	ProxyServer initialize failure, SystemFile error
ErrorDescription00040F85	ProxyServer initialize failure, OpenActioner error
ErrorDescription00040F86	ProxyServer initialize failure, OpenService error
ErrorDescription00041000	EtherCAT mode error
ErrorDescription00041001	FreeBot error
ErrorDescription00041002	[Error][System]Internal high speed communication failure
ErrorDescription00041003	[Error][Motion]Robot motion error
ErrorDescription00041004	EtherCAT command error
ErrorDescription00041005	EtherCAT error
ErrorDescription00041006	RETEX4 build failed
ErrorDescription00041007	Simulate mode error
ErrorDescription00041008	[Error][Motion]Over Working Area
ErrorDescription00041009	Rtx start failure
ErrorDescription0004100A	Rtx lincense failure
ErrorDescription00042000	Actioner Start failed
ErrorDescription00042001	Actioner Run failed
ErrorDescription00042002	Actioner Pause failed
ErrorDescription00042003	Actioner Warning
ErrorDescription00042004	Actioner exception when Start Or Pause
ErrorDescription00042005	Actioner exception when Stop
ErrorDescription00042006	Actioner write file error
ErrorDescription00042007	Actioner code error
ErrorDescription00042008	Actioner variable type mismatch
ErrorDescription00042009	Actioner execute robot failed

ErrorDescription0004200A	Error during project warp
ErrorDescription0004200B	Variable is not found
ErrorDescription00043000	Vision server error
ErrorDescription00043001	Vision is not initialized
ErrorDescription00043002	Vision SmartPick error
ErrorDescription00043003	[Vision][Error]Vision Job file error
ErrorDescription00043004	[Vision][Error]Vison job file not found
ErrorDescription00043005	Vision command format error
ErrorDescription00043006	[Error][Hardware]Vision reply message error
ErrorDescription00043007	Vision job is not started
ErrorDescription00043008	Vision unknown command received
ErrorDescription00043009	Vision found nothing
ErrorDescription0004300A	Vision actioner time-out
ErrorDescription0004300B	[Error][VISION]Vision actioner reply data is not applicable
ErrorDescription0004300C	Vision job is already running
ErrorDescription0004300D	Vision actioner initialization fail
ErrorDescription0004300E	Vision calibration error
ErrorDescription00044000	[info.]Modbus object initializing
ErrorDescription00044001	Modbus socket read
ErrorDescription00044002	Modbus error
ErrorDescription00044003	[info.][com.]Modbus data wrote
ErrorDescription00044004	Modbus data received
ErrorDescription00044005	[info.]Modbus serial port open
ErrorDescription00044200	CIFX enable
ErrorDescription00044201	CIFX disable
ErrorDescription00044202	CIFX enable fail
ErrorDescription00044203	CIFX disable fail
ErrorDescription00044204	CIFX enable/disable fail
ErrorDescription00044205	CIFX general error
ErrorDescription00044206	CIFX driver error
ErrorDescription00044207	CIFX communication error
ErrorDescription00044208	CIFX exception error
ErrorDescription00044209	No setup CIFX physical device
ErrorDescription0004420A	No setup CIFX device driver
ErrorDescription0004420B	No setup CIFX physical device and device driver
ErrorDescription0004420C	Setup the wrong CIFX firmware or config

ErrorDescription00044280	[Error][Com.]Profinet read fail
ErrorDescription00044281	[Error][Com.]Profinet write fail
ErrorDescription00045000	[Error][External Device]USB with correct name does not exist.
ErrorDescription00045001	[Error][Software]No Space for External Device
ErrorDescription00045002	No support offered
ErrorDescription00045003	[Error][com.]Data exchange failed. File may be accessed.
ErrorDescription00045004	[Error][Com.]File not found
ErrorDescription00045005	[Error][Com.]Read data file failed
ErrorDescription00045006	[Error][Com.]Client connect server failed
ErrorDescription00045007	[Error][Com.]Client connection failed
ErrorDescription00045008	[Error][Com.]Client send command failed
ErrorDescription00045009	Command timeout
ErrorDescription0004500A	[Error][Com.]TCP listener error
ErrorDescription0004500B	[Error][Com.]Configure network failed
ErrorDescription0004500C	[Hardware][Error]No Space for Application Directory
ErrorDescription0004500D	UNC path could not be access
ErrorDescription00045100	[Error][Software]Incomplete update
ErrorDescription00045101	Application update is not executed
ErrorDescription00046000	Web command error
ErrorDescription00047000	TMManager object initialization error
ErrorDescription00048000	[Error][Flow]Invalid syntax error
ErrorDescription00048001	[Flow][Error]Invalid number format
ErrorDescription00048002	[Flow][Error]Duplicated cases of switch
ErrorDescription00048003	[Flow][Error]Duplicate declaration
ErrorDescription00048004	[Error][Flow]Invalid expression error
ErrorDescription00048005	Undefined variables
ErrorDescription00048006	[Error][Flow]Undefined functions
ErrorDescription00048007	[Flow][Error]Function operation is not allowed
ErrorDescription00048008	[Error][Flow]Array operation is not allowed
ErrorDescription00048009	[Error][Flow]Array Index is not an integer number
ErrorDescription0004800A	[Error][Flow]Calculation is not a Number
ErrorDescription0004800B	[Error][Flow]Calculation is not an Integer Number
ErrorDescription0004800C	[Error][Flow]Calculation is not a Variables
ErrorDescription0004800D	[Flow][Error]Calculation is not an Integer Variables
ErrorDescription0004800E	[Error][Software]Calculation is not a Boolean
ErrorDescription0004800F	[Error][Flow]Data type is different, can not assign operation

ErrorDescription00048010	[Error][Software]Data type is different, can not compare operation
ErrorDescription00048011	[Error][Flow]Invalid Number Range
ErrorDescription00048012	[Error][Software]Missing Right Parentheses
ErrorDescription00048013	[Error][Flow]Missing Right Brackets
ErrorDescription00048014	[Error][Flow]Missing Right Brace
ErrorDescription00048015	[Error][Flow]Target Node is not exist
ErrorDescription00048016	[info.][Flow]Division by Zero
ErrorDescription00048017	[info.][Flow]Modulo by Zero
ErrorDescription00048018	[Error][Flow]Invalid Array Index
ErrorDescription00048019	Invalid Type Value
ErrorDescription0004801A	Invalid Index Value
ErrorDescription0004801B	[Error][Flow]Invalid Number Value
ErrorDescription0004801C	[Error][External Device]Force-Torque sensor open failed
ErrorDescription0004801D	[Error][Com.]Modbus open failed
ErrorDescription0004801E	Serial Port open failed
ErrorDescription0004801F	[Error][Flow]Exception Error
ErrorDescription00048020	[Error][Com.]Modbus read failed
ErrorDescription00048021	[Error][Com.]Modbus write failed
ErrorDescription00048022	Parameter key is not exist
ErrorDescription00048023	Parameter value is invalid
ErrorDescription00048024	File does not exist
ErrorDescription00048025	File size is too large
ErrorDescription00048026	File is read only
ErrorDescription00048027	File is exists, could not write
ErrorDescription00048028	File create error
ErrorDescription00048029	File delete error
ErrorDescription0004802A	File operation error
ErrorDescription0004802B	Array datatype is different, could not operation
ErrorDescription0004802C	Array size is max
ErrorDescription0004802D	Array start index is invalid
ErrorDescription0004802E	Ethernet Slave is disabled
ErrorDescription0004802F	Ethernet Slave Item name does not exist
ErrorDescription00048030	Ethernet Slave Item value is error
ErrorDescription00048601	[Warning][Flow]Warning Counter
ErrorDescription00048602	[Warning][Flow]Warning for String Format
ErrorDescription00048603	[Warning][Flow]Warning for Number Value maybe missing

ErrorDescription00048604	[Flow][Warning]Warning for String Format include Variables
ErrorDescription00048605	[Flow][Warning]Warning for Network path could not be access
ErrorDescription00048A00	Could not Play if Previous Project is not stopped
ErrorDescription0004F000	Common Info
ErrorDescription00050000	No Error
ErrorDescription0005FF20	Solenoid current is NG
ErrorDescription0005FF21	Joint movement range is NG in brake release status
ErrorDescription0005FFA0	The voltage on DCBUS is too low (40V)
ErrorDescription0005FFA1	The voltage on DCBUS is too high (60V)
ErrorDescription0005FFA2	The acceleration on X direction of G sensor is out of range
ErrorDescription0005FFA3	The acceleration on Y direction of G sensor is out of range
ErrorDescription0005FFA4	The acceleration on Z direction of G sensor is out of range
ErrorDescription0005FFA5	The temperature on PCB is too high (90 degree Celsius)
ErrorDescription0005FFA6	The current in U phase of motor is too high
ErrorDescription0005FFA7	The current in V phase of motor is too high
ErrorDescription0005FFA8	The current in W phase of motor is too high
ErrorDescription0005FFA9	The overcurrent is protected by current sensor of U phase
ErrorDescription0005FFAA	The overcurrent is protected by current sensor of V phase
ErrorDescription0005FFAB	The protection is on for motor hold
ErrorDescription0005FFAC	The initial angle of three phase of motor is not correct
ErrorDescription0005FFAD	The index angle of encoder is not calibrated
ErrorDescription0005FFAE	Overcurrent in DCBUS
ErrorDescription0005FFAF	The communication of EtherCAT is timeout
ErrorDescription0005FFB1	The communication of SPI is timeout
ErrorDescription0005FFB2	Illegal interrupt to MCU
ErrorDescription0005FFB3	The watch dog of MCU is timeout
ErrorDescription0005FFB4	The initialization of joint coordinate is timeout
ErrorDescription0005FFB5	FW version doesn't match HW version
ErrorDescription0005FFB6	The process in main loop is timeout
ErrorDescription0005FFB7	Brake release failed.
ErrorDescription0005FFB8	Gate Driver NG
ErrorDescription0005FFB9	MOFSET NG
ErrorDescription0005FFBA	Current Sensor NG
ErrorDescription0005FFC0	The deviation is too high when initializing joint coordinate
ErrorDescription0005FFC1	Runin process R2: Z index miss
ErrorDescription0005FFC2	Runin process R2: multi Z index happened

ErrorDescription0005FFC3	Runin process R2: U signal NG
ErrorDescription0005FFC4	Runin process R2: V signal NG
ErrorDescription0005FFC5	Runin process R2: W signal NG
ErrorDescription0005FFC6	Runin process R2: the sequence of UVW is NG
ErrorDescription0005FFC7	Runin process R2: AB signal is NG
ErrorDescription0005FFC8	Failure in loading data from EEPROM
ErrorDescription0005FFC9	The electrical angle of motor is not correct (warning)
ErrorDescription0005FFCA	Multi Z index happened in encoder output
ErrorDescription0005FFCB	The deviation between command and current position is too high
ErrorDescription0005FFCC	The Z index signal is missing
ErrorDescription0005FFCD	Encoder connection failed
ErrorDescription0005FFCE	The compensation of encoder signal is too high
ErrorDescription0005FFCF	The protection is on for motor hold (type 2)
ErrorDescription0005FFD0	The UVW signal of encoder is NG
ErrorDescription0005FFD1	The data is abnormal when reading magnetic encoder.
ErrorDescription0005FFD2	The magnet is NG judged by magnetic encoder
ErrorDescription0005FFD3	The origin of joint module is out of preset
ErrorDescription0005FFD4	The data in EEPROM is dislocated
ErrorDescription0005FFD5	The parameters for joint module are abnormal
ErrorDescription0005FFD6	The process of I2C control flow is out of control
ErrorDescription0005FFD7	Runin process R2: index calibration failed
ErrorDescription0005FFD8	The resistance of UVW of motor is abnormal
ErrorDescription0005FFD9	The connection sequence of UVW of motor is not correct
ErrorDescription0005FFDA	Runin process R2: the current in UVW phase is NG
ErrorDescription0005FFDB	Runin process R4: UVW calibration result is out of limit
ErrorDescription0005FFDC	Runin process : G sensor calibration result is out of limit
ErrorDescription0005FFDD	An error occurs when command changes the control mode.
ErrorDescription0005FFDE	Changing EtherCAT ESM when PDS is in OP mode
ErrorDescription0005FFDF	Unknown EtherCAT ESM command
ErrorDescription0005FFE0	The voltage of DC bus is low in EtherCAT OP mode
ErrorDescription0005FFE1	Online multiturn calibration failed
ErrorDescription0005FFE2	The magnetic encoder data is not stable in the position initialization process
ErrorDescription0005FFE3	The joint angle between "power on" and "position initialization" exceeds limit
ErrorDescription0005FFE4	The position initialization process is timeout ("Z search" is not finished)
ErrorDescription0005FFE5	The position initialization process is timeout
ErrorDescription0005FFE6	The result is NG in position initialization process

ErrorDescription0005FFE7	Runin process: the process of g sensor calibration is NG
ErrorDescription0005FFE8	The output of g sensor is NG
ErrorDescription0005FFE9	The check sum result from EEPROM data is abnormal
ErrorDescription0005FFEA	The voltage of 5V is NG
ErrorDescription0005FFEB	The voltage of 12V is NG
ErrorDescription0005FFEC	The ADC compensation is out of limit
ErrorDescription0005FFED	The compensation of encoder signal is too high in ABS mode
ErrorDescription0005FFEE	The deviation is too high between latching index and position initialization process
ErrorDescription0005FFEF	The parameters of magnetic encoder are abnormal
ErrorDescriptionF0000000	
ErrorDescriptionF0000020	Network Service Command Error
ErrorDescriptionF0000021	UNC format is wrong
ErrorDescriptionF0000022	Invalid Period
ErrorDescriptionF0000023	Invalid Time
ErrorDescriptionF0000024	Login pass
ErrorDescriptionF0000025	Login fail
ErrorDescriptionF0000026	Logout pass
ErrorDescriptionF0000027	Logout fail
ErrorDescriptionF0000028	Over the number of log upload allowed
ErrorDescriptionF0000029	Over the number of robot data allowed
ErrorDescriptionF000002A	Over the number of vision images allowed
ErrorDescriptionF000002B	Over the number of UNC Setting
ErrorDescriptionF000002C	UNC is duplicated
ErrorDescriptionF0000060	File checksum or form type error
ErrorDescriptionF0000061	File path/name error
ErrorDescriptionF0000062	Program object error
ErrorDescriptionF0000063	File's version error
ErrorDescriptionF0000064	File's form type error
ErrorDescriptionF0000065	Communicate Mode error
ErrorDescriptionF0000066	User-defined item exceeds limit
ErrorDescriptionF0000067	Item's name is invalid
ErrorDescriptionF0000068	Item's name is duplicate
ErrorDescriptionF0000069	Item's data type is invalid
ErrorDescriptionF000006A	Item's data length is invalid
ErrorDescriptionF000006B	Item's data accessibility is invalid
ErrorDescriptionF000006C	Item's data writable mode is invalid

ErrorDescriptionF000006D	File save fail
ErrorDescriptionF000006E	Program Exception
ErrorDescriptionF0000080	Error while IODD xml file loading
ErrorDescriptionF0000081	Invalid IODD xml file format
ErrorDescriptionF0000082	IODD xml file contains invalid value
ErrorSuggestion00000001	<p>[Cause]Motion assigned is invalid, mostly because of over working range</p> <p>[Caution]1. Check if the robot is under Singularity</p> <p>2. Check if the motion assigned in MOVE node is out of specification</p> <p>[Additional Explanation] This error is not likely happens, instead, the system will report error code 0x00000009</p> <p>[Additional Explanation] If the settings of MOVE node is out of specification, such as, moving along X axis by 99999 mm</p> <p>[Additional Explanation] If the motion assigned is sure to be correct but with this error occurs, contact and report to Techman Robot Inc.</p> <p>[Solution]To restore the robot from error status:</p> <ol style="list-style-type: none"> 1. Press the STOP button on the robot stick, or 2. Press the FREE button <p>Adjust the motion related nodes in the current project</p> <ol style="list-style-type: none"> 1. Make sure the points used in a Project would not lead to any Singularity 2. Make sure the motion (distance, rotation) assigned in move is available
ErrorSuggestion00000005	Clear this error and keep on going
ErrorSuggestion00000009	<p>[Cause]Motion assigned is invalid</p> <p>[Caution]1. Check if the robot is under Singularity</p> <p>2. Check if the motion assigned in MOVE node is out of specification</p> <p>[Additional Explanation] If the settings of MOVE node is out of specification, such as, moving along X axis by 99999 mm</p> <p>[Additional Explanation] If the motion assigned is sure to be correct but with this error occurs, contact and report to Techman Robot Inc.</p> <p>[Solution]To restore the robot from error status:</p> <ol style="list-style-type: none"> 1. Press the STOP button on the robot stick, or 2. Press the FREE button <p>Adjust the motion related nodes in the current project</p> <ol style="list-style-type: none"> 1. Make sure the points used in a Project would not lead to any Singularity 2. Make sure the motion (distance, rotation) assigned in move is available
ErrorSuggestion0000000A	<p>[Cause]1. 3 points which build a coordinate frame are on the same line</p> <p>2. Motion path set at the position that Robot arm cannot reach.</p> <p>3. End point set at the singularity.</p>

	<p>[Caution]1. Check if the custom base is set properly</p> <p>2. Check if the path used is reachable or not</p> <p>[Precaution] Improper custom base or path might lead to unexpected risk to safety</p> <p>[Solution]1. Click Stop on the robot stick to restore the error status</p> <p>2. Correct the invalid settings</p> <p>3. if this problem still occurs, contact a qualified service engineer for further analysis with log files</p> <p>Make sure that these 3 points which build a coordinate frame were not on the same line or adjust the flow to let motion path in the working range and away from the singularity</p>
ErrorSuggestion00000010	Please make sure that motion path is in the working range and the path is far away from the singularity
ErrorSuggestion00000011	Please make sure that motion path is in the working range and the path is far away from the singularity
ErrorSuggestion00000012	<p>[Cause]Motion assigned is invalid, mostly because of singularity</p> <p>[Caution]1. Check if the robot is under Singularity</p> <p>2. Check if the motion assigned in MOVE node may lead to any singularity</p> <p>[Additional Explanation] This error is not likely happens, instead, the system will report error code 0x00000009</p> <p>[Additional Explanation] If the motion assigned is sure to be correct but with this error occurs, contact and report to Techman Robot Inc.</p> <p>[Solution]To restore the robot from error status:</p> <p>1. Press the STOP button on the robot stick, or</p> <p>2. Press the FREE button</p> <p>Adjust the motion related nodes in the current project</p> <p>1. Make sure the points used in a Project would not lead to any Singularity</p> <p>2. Make sure the motion (distance, rotation) assigned in move is available</p>
ErrorSuggestion00000013	Please contact the original purchase of the manufacturer or a third party designated maintenance unit.
ErrorSuggestion00000014	<p>[Cause]The current approaching action requires a huge variation of joint angles which is over the ability that the motors can do in a single servo command.</p> <p>[Caution]1. Check if the current posture or the destination point is near a singularity point.</p> <p>2. Check if the motion path would likely pass through an internal singularity point.</p> <p>3. Check if the project speed or speed settings of the points are too fast.</p> <p>[Additional Explanation] If the robot moves under the circumstances of singularity (both internal and external) with LINE on motion setting, that may easily cause this error.</p> <p>[Solution]Stop Category: 2</p> <p>To restore the robot from error status:</p> <p>1. Press the STOP button on the robot stick, or</p> <p>2. Press the FREE button.</p> <p>1. Avoid postures or motion paths near singularities.</p> <p>2. Decrease speed If you want to keep the posture or motion path smooth.</p>

ErrorSuggestion00000015	Please make sure that these 3 points which build the circular path are not on the line.
ErrorSuggestion00000016	Please contact the original purchase of the manufacturer or a third party designated maintenance unit.
ErrorSuggestion00000017	Please contact the original purchase of the manufacturer or a third party designated maintenance unit.
ErrorSuggestion00000018	Please make sure that motion path is in the working range and the path is far away from the singularity
ErrorSuggestion00000019	<p>[Cause]Robot can not be stop at the assigned point position with Precise positioning option is checked.</p> <p>[Caution]</p> <p>[Additional Explanations] Since the joint driver can not move to the assigned point position successfully, it would cause this error.</p> <p>[Solution]To restore the robot from Error Status :</p> <ol style="list-style-type: none"> 1. Press STOP button on the robot stick, or 2. Press FREE button.
ErrorSuggestion0000001A	<p>[Cause]Robot detects the LINE motion can not be executed successfully.</p> <p>[Caution]Check if the motion is LINE while the blending radius is set to 0</p> <p>[Additional Explanations] Robot detects the user input the invalid values in the By Radius settings which can not be executed successfully.</p> <p>[Additional Explanation] This could probably happens on POINT or MOVE node</p> <p>[Solution]To restore the robot from Error Status :</p> <ol style="list-style-type: none"> 1. Press STOP button on the robot stick, or 2. Press FREE button. <p>Before running project, check if there is any motion related nodes set to be LINE while the blending radius is set to 0</p>
ErrorSuggestion00000021	<p>[Cause]The robot detected an exceeding TCP speed or Joint speed which is over the limit of the Safety Settings</p> <p>[Caution]1. Check and make sure the TCP speed limit or Joint speed limit on Settings\Safety Settings\Safety Stop Criteria is suitable.</p> <p>2. Check and make sure the TCP speed limit or Joint speed limit on, Settings\Safety Settings\Collaborative Setting\More Limit Setting, is suitable for Collaborative Mode</p> <p>3. Make sure the settings of TCP used are correct, especially the Pose of TCP.</p> <p>4. Check if the issued point is PTP on motion setting.</p> <p>5. Check if the issued point is LINE on motion setting(ABS).</p> <p>[Precaution] This error message would only show in the servo log and would be read by system's voice. It will not be displayed in an HMI error window.</p> <p>[Additional Explanation] If the robot moves under the circumstances of singularity (both internal and external) with PTP on motion setting, that may easily cause this error.</p> <p>[Solution]Stop Category: 2</p> <p>To restore the robot from error status:</p>

1. Press the STOP button on the robot stick, or
2. Press the FREE button.
1. Avoid postures or motion paths near singularities.
2. Decrease the speed If you want to keep the posture or motion path smooth.
3. Make sure the speed limit values of the Safety Settings are suitable in both Manual/Auto Mode and Collaborative Mode.

ErrorSuggestion00000022

[Cause]The robot detected an exceeding TCP force or Joint torque which is over the limit of the Safety Setting

[Caution]1. Check if the robot collides with anything.

2. Check and make sure the TCP force limit or Joint torque on Settings\Safety Settings\Safety Stop Criteria is suitable.

3. Check and make sure the TCP force limit or Joint torque on Settings\Safety Settings\Collaborative Setting\More Limit Setting is suitable for Collaborative Mode

4. Make sure the settings of all TCP/Joint torque used are correct including the pose of TCP, Mass, Mass Center Frame and Principal Moments of Inertia.

5. Make sure the payload setting is correct on every motion related node of the flow, e.g. Point, Move, Pallet, etc.

6. Make sure there are no sudden pauses/stops in the project while the robot is moving at high speed.

[Precaution] Tool with Mass Center Frame far from the flange will add heavy external torque onto the robot. Without the correct TCP settings (including, TCP pose, Mass, Mass Center Frame and Principal Moments of Inertia), the Servo System would likely mistake this for an error.

[Precaution] This error message would only show in the servo log and would be read by system's voice. It will not be displayed in an HMI error window.

[Additional Explanation] The result of TCP force is achieved by calculation. This calculation will be dysfunctional when the robot passes through a singularity zone, and could mistakenly trigger this error.

[Solution]Stop Category: 2

To restore the robot from error status:

1. Press the STOP button on the robot stick, or
2. Press the FREE button.
1. Avoid postures or motion paths near singularities.
2. Decrease the speed If you want to keep the posture or motion path smooth.
3. Make sure the speed limit values of the Safety Settings are suitable in both Manual/Auto Mode and Collaborative Mode.

ErrorSuggestion00000023

[Cause]TCP speed and force are both over limit at the same time.

[Caution]1. Check if the robot has been moving too fast currently

2. Check if the robot has collided to anything

[Additional Explanation] This error code is not likely happen, low possibility, since it always trigger either 0x21 or

	0x22 at the first place
	[Precaution] Assess if it is necessary to drag the robot to a safer space by safe startup mode
	[Solution]1. Click Stop on the robot stick to restore the error status
	2. Reduce the payload or the motion speed
	3. Revise the safety criteria
	1. Make sure the speed of the current is within specification
	2. Make sure the robot would not collide with the surroundings during project run
ErrorSuggestion00000024	[Cause]The robot detected an intense shake.
	[Caution]1. Check if the robot collided with anything in Collaborative Mode.
	2. Check the robot stability while the project is running.
	[Precaution] The environment or location of the robot should be stable.
	[Solution]1. Ensure that the robot's posture, location and motion does not collide with anything
	2. Move or place the robot in a location where it is stable while a project is running
	1. Ensure that the robot's posture, location and motion does not collide with anything.
	2. Move or place the robot in a location where it is stable while a project is running.
ErrorSuggestion0000002D	[Cause] joint type is not match the product of the vendor.
ErrorSuggestion0000002E	gear ratio is not match the model
ErrorSuggestion0000002F	Please reboot the robot. If the error still occurs, please contact the original purchase of the manufacturer or a third party designated maintenance unit.
ErrorSuggestion00000030	[Cause]I/O Board's current over the spec range(1.5A).
	[Caution]
	[Additional Explanations] If the external devices are abnormal that cause current are too large, it would cause this error.
	[Solution]1. Remove all external devices first
	2. After restart the robot, the problem still occurs, contact a qualified service engineer for further analysis.
	Make sure all external device will not consumed over 1.5A from Control box IO
ErrorSuggestion00000031	Please reboot the robot. If the error still occurs, please contact the original purchase of the manufacturer or a third party designated maintenance unit.
ErrorSuggestion00000032	Please reboot the robot. If the error still occurs, please contact the original purchase of the manufacturer or a third party designated maintenance unit.
ErrorSuggestion00000033	[Cause]The TCP speed is too high and over safety setting during any operation in manual mode
	[Caution]Check if the TCP speed is too low on Safety Settings
	Check if the TCP position is too far away from the flange
	[Additional Explanation] This error is not likely happen, usually, other error safety related error code might be triggered first

	<p>[Solution]1. Click Stop on the robot stick to restore the error status</p> <p>2. Adjust the TCP setting and the Safety Setting</p> <p>3. Decrease the setting of the velocity and the setting of the angular velocity on the manual mode.</p> <p>Make sure the safety settings is suitable</p> <p>Make sure any motion related operation (Hand-guiding, step-run, Controller) moves within the safety settings</p>
ErrorSuggestion00000035	<p>[Cause]System has detected an error on joint driver</p> <p>[Caution]Check the other error code come along with it.</p> <p>[Additional Explanation] If there is any joint's driver component error occur.it world all report this error code but user can check the next error code which along with tis error to get the further information.</p> <p>[Solution]To restore the robot from Error Status :</p> <p>1. Depend on the error code after this error, find the corresponding error code description in the error code table.</p> <p>Depend on the error code after this error, find the corresponding error code description in the error code table.</p>
ErrorSuggestion00000036	<p>Please reboot the robot. If the error still occurs, please contact the original purchase of the manufacturer or a third party designated maintenance unit.</p>
ErrorSuggestion00000037	<p>Please reboot the robot. If the error still occurs, please contact the original purchase of the manufacturer or a third party designated maintenance unit.</p>
ErrorSuggestion00000038	<p>Please reboot the robot. If the error still occurs, please contact the original purchase of the manufacturer or a third party designated maintenance unit.</p>
ErrorSuggestion00000039	<p>Please reboot the robot. If the error still occurs, please contact the original purchase of the manufacturer or a third party designated maintenance unit.</p>
ErrorSuggestion0000003A	<p>Please reboot the robot. If the error still occurs, please contact the original purchase of the manufacturer or a third party designated maintenance unit.</p>
ErrorSuggestion0000003B	<p>[Cause]The Joint number will be different with the joint number in setting</p> <p>[Caution]Check if any Robot Joint has been replaced recently</p> <p>[Additional Explanation] This often occurs if the robot joint(s) been replaced or fixed but without proper update on EEPROM</p> <p>[Solution]Contact a qualified service engineer for further analysis</p> <p>[Agent-only] Make sure EEPROM be updated after replacing a Joint module or Power board</p>
ErrorSuggestion0000003C	<p>[Cause]EtherCAT connection failure during power on</p> <p>[Caution]1. Check if the robot cable is connected or not</p> <p>2. If the robot cable is well connected, have a qualified service engineer to check if the Ethernet cable between Power Control Board and IPC Board is connected properly</p> <p>[Restriction] Power off the system and also un-plug the power cable before opening the control box</p> <p>[Additional Explanation] This error would only happen during power on, and is shown on the HMI Error Page only.</p> <p>[Solution]1. Power off the system first</p> <p>2. Check and confirm the corresponding wire/cable is connected properly</p>

	<p>3. Power on the system</p> <p>Before power on the system, you could double check robot cable is well connected to the Control Box</p>
ErrorSuggestion0000003D	<p>Please release the emergency button and reboot the robot. If the error still occurred, please contact the original purchase of the manufacturer or a third party designated maintenance unit.</p>
ErrorSuggestion0000003E	<p>[Cause]The robot detected that voltage is over the specified range (43V~45V) in PreOP mode.</p> <p>[Caution]1. Power eater board malfunction. 2. Power supply abnormal. 3. Robot power cable short-circuited.</p> <p>[Additional Explanation] When a robot is equipped with a power eater board, a short circuit in the power supply or power cable would cause this error.</p> <p>[Additional Explanation] The threshold to trigger the PreOP error is lower than 40V(Electric motor),power eater board is lower than 36.</p> <p>[Solution]To restore the robot from error status :</p> <ol style="list-style-type: none"> 1. Perform the robot restart procedure. 2. If an error still occurs after the restart, please contact a qualified service engineer for additional support. <p>Ensure a secure connection at the power cable terminals.</p>
ErrorSuggestion0000003F	N/A
ErrorSuggestion00000040	<p>[Cause]1. ESI returned unexpected data 2. Joint PCB is abnormal</p> <p>[Caution]</p> <p>[Additional Explanations] When Joint ESI does not match the default setting, it will report this error</p> <p>[Solution]After restart the robot, the problem still occurs, contact a qualified service engineer for further analysis with log files</p>
ErrorSuggestion00000041	<p>[Cause]1. EtherCAT related components are abnormal 2. Joint PCB is abnormal</p> <p>[Caution]</p> <p>[Additional Explanation] When Joint abnormal response SDO command, it will report this error</p> <p>[Solution]</p>
ErrorSuggestion00000042	<p>Please reboot the robot. If the error still occurs, please contact the original purchase of the manufacturer or a third party designated maintenance unit.</p>
ErrorSuggestion00000043	<p>[Cause]TCP/IP stack abnormal.</p> <p>[Caution]</p> <p>[Additional Explanation] This may happen if quality of the network is unstable</p> <p>[Solution]After restart the robot, the problem still occurs, contact a qualified service engineer for further analysis with log files</p>

	Make sure the network is stable
ErrorSuggestion00000044	<p>[Cause]1. EtherCAT related components are abnormal</p> <p>2. Joint PCB is abnormal</p> <p>[Caution]</p> <p>[Additional Explanations] When failed to turn into DC SYNC in the EtherCAT loop, it will report this error</p> <p>[Solution]After restart the robot, the problem still occurs, contact a qualified service engineer for further analysis with log files</p>
ErrorSuggestion00000045	Please reboot the robot. If the error still occurs, please contact the original purchase of the manufacturer or a third party designated maintenance unit.
ErrorSuggestion00000046	Please reboot the robot. If the error still occurs, please contact the original purchase of the manufacturer or a third party designated maintenance unit.
ErrorSuggestion00000047	Please reboot the robot. If the error still occurs, please contact the original purchase of the manufacturer or a third party designated maintenance unit.
ErrorSuggestion00000048	<p>[Cause]The robot detect the voltage is over the spec(48V)range in ESM-OP mode.</p> <p>[Caution]</p> <p>[Additional Explanation] When robot has power supply or power cable short-circuited because of poor contact which would cause this error.</p> <p>[Additional Explanation] The threshold to trigger this error is power board's voltage lower than 48.</p> <p>[Solution]After restart the robot, the problem still occurs, contact a qualified service engineer for further analysis</p> <p>1.Make sure and regularly check if power cable are connected to the robot are firmed enough.</p> <p>2.Before using robot, make sure the power supply is robust for robot running.</p>
ErrorSuggestion00000049	<p>[Cause]Check the power supply is robust for robot running.</p> <p>[Caution]</p> <p>[Additional Explanation] The threshold to trigger this error is power board's voltage lower than 48.</p> <p>[Solution]After restart the robot, the problem still occurs, contact a qualified service engineer for further analysis</p> <p>Before using robot, make sure the power supply is robust for robot running.</p>
ErrorSuggestion0000004A	Please reboot the robot. If the error still occurs, please contact the original purchase of the manufacturer or a third party designated maintenance unit.
ErrorSuggestion0000004B	<p>[Cause]EtherCAT communication has been cut off while the robot is on</p> <p>[Caution]Check if there is any external EtherCAT devices, and if the Ethernet cable is loosen or if they are power off accidentally</p> <p>[Additional Explanation] This usually happens if any EtherCAT devices is cut off, for example, Ethernet cable is loosen or power-off accidentally</p> <p>[Precaution] Power-off and unplug the power cable when checking inside the control box is necessary</p> <p>[Additional Explanation] This may happens if the robot or control box has been placed on a unstable platform or having violent collision.</p>

	<p>[Solution]1. Shutdown the robot</p> <p>2. Restore the external EtherCAT devices and then reboot the robot</p> <p>3. If this still happens, contact a qualified service engineer for further analysis</p> <p>1. Make sure all external EtherCAT devices are well connected and functional</p> <p>2. Make sure the robot would not be collided and be placed on an unstable platform.</p>
ErrorSuggestion0000004C	<p>[Cause]1. EEPROM in Power Board is abnormal</p> <p>2. Power Board is abnormal</p> <p>[Caution]</p> <p>[Additional Explanation] When failed to access EEPROM Data in the Power Board, it will report this error</p> <p>[Solution]</p>
ErrorSuggestion0000004D	<p>[Cause]1. EtherCAT related components are abnormal</p> <p>2. Joint PCB is abnormal</p> <p>[Caution]</p> <p>[Additional Explanation] When failed to access live data from Joint, it will report this error</p> <p>[Solution]</p>
ErrorSuggestion0000004E	<p>[Cause]System has detected a mismatch of S/N between the robot and the control box</p> <p>[Caution]1. Check if the S/N (Serial Number) of the robot arm matches the one on the control box</p> <p>[Additional Explanation] If the S/Ns are correctly matched, there would other possibilities, such as:</p> <p>1. The Power Control Board is damaged</p> <p>2. The EEPROM is not updated correctly after replacing the Robot Joint or Power Control Board</p> <p>[Solution]1. Confirm and make sure the S/Ns are matched between the robot and the control box</p> <p>2. Else, contact a qualified service engineer for further analysis</p> <p>1. Before powering on the system, you could double check the connection about robot cable, and a suitable S/N match about robot arm and control box</p> <p>2. Service Engineers should follow the correct process when replacing the Robot Joints or Power Control Board</p>
ErrorSuggestion0000004F	<p>[Cause]The power control board is not detected during power on</p> <p>[Caution]</p> <p>[Precaution] Power-off and unplug the power cable when checking inside the control box is necessary.</p> <p>[Additional Explanation] This usually happens if the control box has been placed on a unstable platform or having violent collision.</p> <p>[Additional Explanation] This error is less likely happens.</p> <p>[Solution]Contact a qualified service engineer for further analysis</p>

ErrorSuggestion00000050	<p>Make sure the robot would not be collided and be placed on an unstable platform.</p> <p>[Cause]The system could not detect the power control board, or the EtherCAT communication fails</p> <p>[Caution]Check if there is any external EtherCAT devices, and if the Ethernet cable is loosen or if they are power off accidentally</p> <p>[Additional Explanation] This usually happens if any EtherCAT devices is cut off, for example, Ethernet cable is loosen or power-off accidentally</p> <p>[Precaution] Power-off and unplug the power cable when checking inside the control box is necessary</p> <p>[Additional Explanation] This may happens if the robot or control box has been placed on a unstable platform or having violent collision.</p> <p>[Solution]1. Shutdown the robot</p> <p>2. Restore the external EtherCAT devices and then reboot the robot</p> <p>3. If this still happens, contact a qualified service engineer for further analysis</p> <p>1. Make sure all external EtherCAT devices are well connected and functional</p> <p>2. Make sure the robot would not be collided and be placed on an unstable platform.</p>
ErrorSuggestion00000051	<p>[Cause]Power board's temperature is too high because of the environment is too hot or power board is abnormal.</p> <p>[Caution]</p> <p>[Additional Explanation] The servo would trigger this error if the power board's temperature is higher than 80 °C.</p> <p>[Solution]1. Power off the robot and let it cool down for a while (suggest at least half an hour)</p> <p>2. Restart the robot, if the problem still occurs, contact a qualified service engineer for further analysis.</p> <p>Make sure the environment temperature is within the specification (0~50 °C) when robot is running.</p>
ErrorSuggestion00000052	<p>[Cause]1. Emergency Stop Button on the robot stick has been pressed.</p> <p>2. The extension port(s) for Emergency Stop has been triggered.</p> <p>3. The external safety device input discrepancy.</p> <p>[Caution]1. Check that the wire between the robot stick and the control box is securely connected and is not triggered.</p> <p>2. Check if the wire on the extension port(s) for emergency stop is securely connected and is not triggered.</p> <p>3. Check if the wire on the external safety device port(s) is securely fastened.</p> <p>[Precaution] When the situation above is triggered, the robot will enter cat.1 stop, which means the power is cut off after the robot speed has been decreased to zero. If there are any payloads on the TCP, without drive power, the TCP will tend to droop a little bit before coming to a complete stop. Please be aware of the tool (payload) colliding with objects in close proximity.</p> <p>[Solution]If the emergency stop button on the robot stick has been pressed:</p> <p>1. Release the e-stop button.</p> <p>a. The robot mode indicator lights will blink red.</p>

b. After a few seconds, the robot mode indicator will blink light blue, indicating the robot has entered safe start-up mode.

c. Long press STOP button for few seconds and release to back to robot normal operation mode.

If an external emergency stop button has been pressed:

1. Release the external e-stop button.

a. The robot mode indicator lights will blink red.

b. After a few seconds, the robot mode indicator will blink light blue, indicating the robot has entered safe start-up mode.

c. Long press STOP button for few seconds and release to back to robot normal operation mode.

If discrepancy happens in external safety device input:

1. Plug the wire back in to the port.

2. Trigger (and or untrigger) the external safety input device.

a. The robot mode indicator lights will blink red.

b. After a few seconds, the robot mode indicator will blink light blue, indicating the robot has entered safe start-up mode.

c. Long press STOP button for few seconds and release to back to robot normal operation mode.

1. Place the robot stick or the external emergency stop button in a location to make sure it is reachable while not being pressed accidentally.

2. Check if the robot stick cable and the wire connected to the emergency stop ports are firmly connected.

3. Ensure that all wires connected to the external safety device port(s) are securely connected.

ErrorSuggestion00000053 [Cause]The robot detected that voltage is over the specified range.

[Caution]Ensure that the input power is within the working range.

[Additional Explanation] Error can be caused when the payload is large, and the ABS speed is very fast.

[Additional Explanation] A power eater board malfunction, power supply abnormality or a short circuited power cable can also be the cause of this error.

[Solution]To restore the robot from error status:

1. Perform the robot restart procedure.

2. If there are any problems on the hardware after the restart procedure, please contact a qualified service engineer for additional support.

1. Avoid setting the ABS speed to fast in point nodes. This is especially important when the robot is moving with large payloads.

2. Ensure the power cables are securely connected.

ErrorSuggestion00000054	<p>[Cause]Power supply is abnormal</p> <p>[Caution]</p> <p>[Additional Explanation] 48V Power Supply over current may possibly caused by the following reasons:</p> <ol style="list-style-type: none"> 1. There may have short circuit within the system (power supply, power board, joint) 2. The current project is with payload and speed over specification 3. The Joint is abnormal <p>[Solution]1. Restart the robot.</p> <ol style="list-style-type: none"> 2. Remove the payload or slow down the project speed 3. If the problem still occur, contact a qualified service engineer for further analysis. <ol style="list-style-type: none"> 1. Avoid and make sure the robot would not collided with the surroundings during running project or carrying. 2. Prevent to use the robot with high speed and heavy payload that are out of specification
ErrorSuggestion00000055	<p>[Cause]The robot detect the current is over the range from 24V Power Supply.</p> <p>[Caution]</p> <p>[Additional Explanation] 24V Power Supply over current may possibly caused by the following reasons:</p> <ol style="list-style-type: none"> 1. Power board is abnormal 2. IO is accidentally shorten 3. IO is connected with a over spec. load (1.5 A) 4. etc. <p>[Solution]1. Remove all IO connection and restart the robot.</p> <ol style="list-style-type: none"> 2. If the problem still occur, contact a qualified service engineer for further analysis. <ol style="list-style-type: none"> 1. Beware and prevent short circuit on IO connection 2. Not to have over loading on IO power supply
ErrorSuggestion00000056	<p>[Cause]Robot detects an connection error on I/O Board</p> <p>[Caution]</p> <p>[Additional Explanation] If the control box is placed on an unstable platform, it may cause the cables loosen.</p> <p>[Precaution] Power off and unplug the power cable before opening the control box for items checking</p> <p>[Solution]After restart the robot, the problem still occur, contact a qualified service engineer for further analysis</p> <p>Make sure the robot would not be collided and be placed on an unstable platform.</p>
ErrorSuggestion00000057	<p>[Cause]Motor driver connection is abnormal</p> <p>[Caution]</p> <p>[Precaution] Shutdown the robot before checking the inside of the joint</p> <p>[Solution]After restart the robot, the problem still occurs, contact a qualified service engineer for further analysis with log files</p> <p>Make sure the robot is working on a stable platform</p>
ErrorSuggestion00000058	<p>Please reboot the robot. If the error still occurs, please contact the original purchase of the manufacturer or a third party designated maintenance unit.</p>

ErrorSuggestion00000059	Please reboot the robot. If the error still occurs, please contact the original purchase of the manufacturer or a third party designated maintenance unit.
ErrorSuggestion0000005A	Please reboot the robot. If the error still occurs, please contact the original purchase of the manufacturer or a third party designated maintenance unit.
ErrorSuggestion0000005B	Press the play button on the stick to clear the alarm.
ErrorSuggestion0000005C	[Cause]1. Stick buzzer is abnormal 2. Power Board is abnormal [Caution] [Additional Explanation] When system get abnormal return data of stick buzzer, it will report this error [Solution]
ErrorSuggestion0000005D	[Cause]EtherCAT BUS is lost. [Caution] [Additional Explanations] Usually, it requires 1ms to complete a communication cycle, but the last signal delayed for more than 5 ms. [Solution]After restart the robot, the problem still occurs, contact a qualified service engineer for further analysis with log files
ErrorSuggestion0000005E	[Cause]Safety Monitor Board detects some hardware or component are abnormal. [Caution] [Additional Explanations] Safety Monitor Board is responsible for monitoring whether each component has normal communication. [Solution]After restart the robot, the problem still occurs, contact a qualified service engineer for further analysis.
ErrorSuggestion0000005F	It is a test input pin triggered.
ErrorSuggestion00000060	[Cause]When user press FREE Button and using Controller at same time, it would cause this issue. [Caution]Check the FREE Button or Controller are both pressed by something or someone at the same time [Additional Explanations] When user press FREE Button and using Controller at the same time, it means user send the motion command to robot, it would cause the conflict. [Solution]To restore the robot from Error Status : Stop pressing one of the free button or controller. Check and avoid the FREE Button and the Controller are pressed at same time.
ErrorSuggestion00000061	Motion command is not allowed with compliance mode at the same time
ErrorSuggestion00000062	[Cause]Robot reaches Singularity during Hand-Guiding [Caution]Check the FREEBOT settings on Controller, see if there are any axes is disable [Additional Explanation] In Controller\FREEBOT\Custom Setting, if some of the axe or joints are disable, hand-guiding may trigger this error [Solution]1. Go to Controller\FREEBOT and change the setting to "Free all Joints" 2. Press the FREE Button to drag the robot back from singularity position

ErrorSuggestion00000063	Make sure the motion of the robot will not trigger singularity before disable the axes or joints for Hand-guiding please set to "free all joints" in the teach mode and move the pose of the robot away from singularity.
ErrorSuggestion0000006A	It is a test command
ErrorSuggestion0000006E	<p>[Cause]An unintended motion is detected while the robot is still in Cat. 2 Stop status.</p> <p>[Caution]1. Check the log for any Cat. 2 stop codes prior to the current error code. 2. Check if a collision occurred or if a joint is jammed</p> <p>[Additional Explanation] This safety function is automatically activated after every Cat.2 Stop. Encoders of each joint are monitored continuously to check if there is any unintended motion, until the user acknowledges and manually recovers the robot from Cat.2 Stop status. If there is any unintended motion, this safety function will trigger a Cat.0 Stop, cutting the power supply directly to the robot.</p> <p>[Precaution] When the Encoder Standstill is triggered, the robot will enter Cat.0 stop, which means the power is cut off immediately; If there is any payload on the TCP, without drive power, the TCP will drop a little before coming to a complete stop. Please be aware that the tool (payload) does not collide with nearby objects.</p> <p>[Solution]1. Press the Stop Button on the robot stick to disengage the "Funct. Alarm Stop" (which is shown on the LCD on the control box" 2. The LED signals on the robot stick will switch from slow blinking red to fast blinking of all 3 LEDs 3. Hold the Power Button on the robot stick for a few seconds to shut down the robot. 4. Press the power button on the robot stick to power on the system again. Remember there should be no motion before the protective stop (Cat. 2) is disengaged.</p>
ErrorSuggestion0000006F	Please reboot the robot. If the error still occurs, please contact the original purchase of the manufacturer or a third party designated maintenance unit.
ErrorSuggestion00000070	<p>[Cause]Robot detects an unexpected error of vision servoing.</p> <p>[Caution]</p> <p>[Additional Explanation] This error should not likely happen.</p> <p>[Solution]If this error happens, contact to your agent or Techman Robot Inc. with the issued Project file.</p>
ErrorSuggestion00000071	Please make sure the Image is recognized and the vision servoing is keep working
ErrorSuggestion00000072	<p>[Cause]Robot is too close or at singularity during serving process.</p> <p>[Caution]Check if the pose of the robot is too close or at singularity during vision serving process.</p> <p>[Additional Explanation] The possibility of robot moves into singularity depends of the initial (view) point chosen or the Moving Range settings of Visual Servoing</p> <p>[Precaution] Please assess the risk of collision during servoing during project editing</p> <p>[Solution]To restore the robot from Error Status :</p> <ol style="list-style-type: none"> 1. Press the STOP button on the robot stick to stop the project. 2. Press FREE button to remove the robot from Singularity. 1. Set up the initial (view) point of the vision job properly to make sure the robot would not enter Singularity 2. Set up the Moving Range of Servoing properly to make sure the robot would not enter Singularity or hit anything

	of the layout
	3. It is suggested to use Fixed Point for object localization instead of Visual Servoing for non-open workspace (too narrow for servoing movement)
ErrorSuggestion00000073	Please calibrated the vision again.
ErrorSuggestion00000074	Please reboot the robot. If the error still occurs, please contact the original purchase of the manufacturer or a third party designated maintenance unit.
ErrorSuggestion00000075	Please make sure the Image is recognized stably.
ErrorSuggestion00000076	Please reboot the robot. If the error still occurs, please contact the original purchase of the manufacturer or a third party designated maintenance unit.
ErrorSuggestion00000080	Please contact the original purchase of the manufacturer or a third party designated maintenance unit.
ErrorSuggestion00000081	Please contact the original purchase of the manufacturer or a third party designated maintenance unit.
ErrorSuggestion00000082	Please contact the original purchase of the manufacturer or a third party designated maintenance unit.
ErrorSuggestion00000083	Please contact the original purchase of the manufacturer or a third party designated maintenance unit.
ErrorSuggestion00000084	Please contact the original purchase of the manufacturer or a third party designated maintenance unit.
ErrorSuggestion00000085	Please contact the original purchase of the manufacturer or a third party designated maintenance unit.
ErrorSuggestion00000086	Please contact the original purchase of the manufacturer or a third party designated maintenance unit.
ErrorSuggestion00000090	[Cause]Path execution error on PATH node [Caution]Check if the path would approaches any singularity [Additional Explanations] If the continuous point planned by user then execute occur error, it would cause this error [Solution]1. Press STOP button on the robot stick to stop the project 2. Adjust the path before usage Make sure the path used would not approaches any singularity
ErrorSuggestion000000A0	[Cause]Violate Encoder Standstill when no motion is allowed. [Caution]Check whether there are others error log along with this error. [Solution]1. Restart the robot. 2. If the problem still occur, contact a qualified service engineer for further analysis
ErrorSuggestion000000A1	[Cause]Violate Encoder Standstill when error occurred. [Caution]Check whether there are others error log along with this error. [Solution]1. Restart the robot. 2. If the problem still occur, contact a qualified service engineer for further analysis
ErrorSuggestion000000A2	[Cause]Violate Encoder Standstill when Safeguard Port A triggered [Caution]Check whether there are others error log along with this error. [Solution]1. Restart the robot. 2. If the problem still occur, contact a qualified service engineer for further analysis
ErrorSuggestion000000A3	[Cause]Violate Encoder Standstill when no motion is allowed. [Caution]Check whether there are others error log along with this error.

	<p>[Solution]1. Restart the robot.</p> <p>2. If the problem still occur, contact a qualified service engineer for further analysis</p>
ErrorSuggestion000000A4	<p>[Cause]Violate Encoder Standstill in stop area.</p> <p>[Caution]Check whether there are others error log along with this error.</p> <p>[Solution]1. Restart the robot.</p> <p>2. If the problem still occur, contact a qualified service engineer for further analysis</p>
ErrorSuggestion000000A6	<p>[Cause] Dual channel Internal Protective Output do not trigger at the same time.</p> <p>[Caution] Fault(s) occurs in the internal system.</p> <p>[Solution]1. Restart the robot.</p> <p>2. If the problem still occur, contact a qualified service engineer for further analysis</p>
ErrorSuggestion000000A7	<p>[Cause] Dual channel Encoder Standstill Output do not trigger at the same time.</p> <p>[Caution] Fault(s) occurs in the internal system.</p> <p>[Solution]1. Restart the robot.</p> <p>2. If the problem still occur, contact a qualified service engineer for further analysis</p>
ErrorSuggestion000000A8	<p>[Cause]Dual channel emergency stop ports do not trigger at the same time.</p> <p>[Caution]Check if the wire on the extension port(s) for emergency stop is securely fastened.</p> <p>[Additional Explanations] In order to comply with safety regulations, the emergency button external ports were designed to be simultaneously triggered.</p> <p>[Solution]1. Plug the wire back in to the port.</p> <p>2. Press (and or release) the external emergency stop button.</p> <ol style="list-style-type: none"> a. The robot mode indicator lights will blink red. b. After a few seconds, the robot mode indicator will blink light blue, indicating the robot has entered safe start-up mode. <p>Ensure that all wires connected to the emergency stop ports are securely connected.</p>
ErrorSuggestion000000A9	<p>[Cause] Dual channel safeguard port A do not trigger at the same time.</p> <p>[Caution] Check if the wire on the exteranal port(s) is securely fastened.</p> <p>[Solution]1. Plug the wire back in to the port.</p> <p>2. Trigger (and or untrigger) the external safety input device.</p> <p>Ensure that all wires connected to Safeguard Port A are securely connected.</p>
ErrorSuggestion000000AA	<p>[Cause] Dual channel safeguard port B do not trigger at the same time.</p> <p>[Caution] Check if the wire on the exteranal port(s) is securely fastened.</p> <p>[Solution]1. Plug the wire back in to the port.</p> <p>2. Trigger (and or untrigger) the external safety input device.</p> <p>Ensure that all wires connected to Safeguard Port B are securely connected.</p>
ErrorSuggestion000000AB	<p>[Cause] Dual channel Enabling Device Ports do not trigger at the same time.</p> <p>[Caution] Check if the wire on the exteranal port(s) is securely fastened.</p>

	<p>[Solution]1. Plug the wire back in to the port.</p> <p>2. Trigger (and or untrigger) the external safety input device.</p> <p>Ensure that all wires connected to Enabling Device Ports are securely connected.</p>
ErrorSuggestion000000AD	<p>[Cause] Dual channel Emergency Stop Output do not trigger at the same time.</p> <p>[Caution] Fault(s) occurs in the internal system.</p> <p>[Solution]1. Restart the robot.</p> <p>2. If the problem still occur, contact a qualified service engineer for further analysis</p>
ErrorSuggestion000000AE	<p>[Cause] Dual channel Safeguard Port A Output do not trigger at the same time.</p> <p>[Caution] Fault(s) occurs in the internal system.</p> <p>[Solution]1. Restart the robot.</p> <p>2. If the problem still occur, contact a qualified service engineer for further analysis</p>
ErrorSuggestion000000AF	<p>[Cause] Dual channel Safeguard Port B Output do not trigger at the same time.</p> <p>[Caution] Fault(s) occurs in the internal system.</p> <p>[Solution]1. Restart the robot.</p> <p>2. If the problem still occur, contact a qualified service engineer for further analysis</p>
ErrorSuggestion000000B0	<p>1. Please backup the HMI Log.</p> <p>2. Please contact the original purchase of the manufacturer or a third party designated maintenance unit.</p>
ErrorSuggestion000000F0	N/A
ErrorSuggestion00008000	<p>[Cause]Dual channel emergency stop ports do not trigger at the same time.</p> <p>[Caution]Check if the wire on the extension port(s) for emergency stop is securely fastened.</p> <p>[Additional Explanations] In order to comply with safety regulations, the emergency button external ports were designed to be simultaneously triggered.</p> <p>[Solution]1. Plug the wire back in to the port.</p> <p>2. Press (and or release) the emergency stop button.</p> <ol style="list-style-type: none"> a. The robot mode indicator lights will blink red. b. After a few seconds, the robot mode indicator will blink light blue, indicating the robot has entered safe start-up mode. c. Long press STOP button for few seconds and release to back to robot normal operation mode. <p>Ensure that all wires connected to the emergency stop ports are securely connected.</p>
ErrorSuggestion00008001	<p>[Cause]Dual channel emergency stop ports do not trigger at the same time.</p> <p>[Caution]Check if the wire on the extension port(s) for emergency stop is securely fastened.</p> <p>[Additional Explanations] In order to comply with safety regulations, the emergency button external ports were designed to be simultaneously triggered.</p> <p>[Solution]1. Plug the wire back in to the port.</p> <p>2. Press (and or release) the emergency stop button.</p>

ErrorSuggestion00008002

- a. The robot mode indicator lights will blink red.
- b. After a few seconds, the robot mode indicator will blink light blue, indicating the robot has entered safe start-up mode.
- c. Long press STOP button for few seconds and release to back to robot normal operation mode.

Ensure that all wires connected to the emergency stop ports are securely connected.

[Cause] Dual channel safeguard port A do not trigger at the same time.

[Caution] Check if the wire on the external port(s) is securely fastened.

[Solution]1. Plug the wire back in to the port.

2. Trigger (and or untrigger) the external safety input device.

- a. The robot mode indicator lights will blink red.
- b. After a few seconds, the robot mode indicator will blink light blue, indicating the robot has entered safe start-up mode.
- c. Long press STOP button for few seconds and release to back to robot normal operation mode.

Ensure that all wires connected to the safeguard port A ports are securely connected.

ErrorSuggestion00008003

[Cause] Dual channel safeguard port B do not trigger at the same time.

[Caution] Check if the wire on the external port(s) is securely fastened.

[Solution]1. Plug the wire back in to the port.

2. Trigger (and or untrigger) the external safety input device.

- a. The robot mode indicator lights will blink red.
- b. After a few seconds, the robot mode indicator will blink light blue, indicating the robot has entered safe start-up mode.
- c. Long press STOP button for few seconds and release to back to robot normal operation mode.

Ensure that all wires connected to the safeguard port B ports are securely connected.

ErrorSuggestion00008004

[Cause] Dual channel Enabling Device Ports do not trigger at the same time.

[Caution] Check if the wire on the external port(s) is securely fastened.

[Solution]1. Plug the wire back in to the port.

2. Trigger (and or untrigger) the external safety input device.

- a. The robot mode indicator lights will blink red.
- b. After a few seconds, the robot mode indicator will blink light blue, indicating the robot has entered safe start-up mode.
- c. Long press STOP button for few seconds and release to back to robot normal operation mode.

Ensure that all wires connected to Enabling Device Ports are securely connected.

ErrorSuggestion00008005	<p>[Cause] Dual channel System Emergency Stop Ports do not trigger at the same time.</p> <p>[Caution] Check if the wire on the external port(s) is securely fastened.</p> <p>[Solution]1. Plug the wire back in to the port.</p> <p>2. Press (and or release) the System Emergency Stop Ports input device.</p> <ol style="list-style-type: none"> a. The robot mode indicator lights will blink red. b. After a few seconds, the robot mode indicator will blink light blue, indicating the robot has entered safe start-up mode. c. Long press STOP button for few seconds and release to back to robot normal operational mode. <p>Ensure that all wires connected to System Emergency Stop Ports are securely connected.</p>
ErrorSuggestion00008006	<p>[Cause] Dual channel safeguard port do not trigger at the same time.</p> <p>[Caution] Check if the wire on the external port(s) is securely fastened.</p> <p>[Solution]1. Plug the wire back in to the port.</p> <p>2. Trigger (and or untrigger) the external safety input device.</p> <p>Ensure that all wires connected to Safeguard Port are securely connected.</p>
ErrorSuggestion00008007	<p>[Cause] Dual channel safeguard port do not trigger at the same time.</p> <p>[Caution] Check if the wire on the external port(s) is securely fastened.</p> <p>[Solution]1. Plug the wire back in to the port.</p> <p>2. Trigger (and or untrigger) the external safety input device.</p> <p>Ensure that all wires connected to Safeguard Port are securely connected.</p>
ErrorSuggestion00008008	<p>[Cause] Dual channel Emergency Stop Output do not trigger at the same time.</p> <p>[Caution] Fault(s) occurs in the internal system.</p> <p>[Solution]1. Restart the robot.</p> <p>2. If the problem still occur, contact a qualified service engineer for further analysis</p>
ErrorSuggestion00008009	<p>[Cause] Dual channel Safeguard Port A Output do not trigger at the same time.</p> <p>[Caution] Fault(s) occurs in the internal system.</p> <p>[Solution]1. Restart the robot.</p> <p>2. If the problem still occur, contact a qualified service engineer for further analysis</p>
ErrorSuggestion0000800A	<p>[Cause] Dual channel Safeguard Port B Output do not trigger at the same time.</p> <p>[Caution] Fault(s) occurs in the internal system.</p> <p>[Solution]1. Restart the robot.</p> <p>2. If the problem still occur, contact a qualified service engineer for further analysis</p>
ErrorSuggestion0000800B	<p>[Cause] Dual channel Internal Protective Output do not trigger at the same time.</p> <p>[Caution] Fault(s) occurs in the internal system.</p> <p>[Solution]1. Restart the robot.</p> <p>2. If the problem still occur, contact a qualified service engineer for further analysis</p>

ErrorSuggestion0000800C	<p>[Cause] Dual channel Encoder Standstill Output do not trigger at the same time.</p> <p>[Caution] Fault(s) occurs in the internal system.</p> <p>[Solution]1. Restart the robot.</p> <p>2. If the problem still occur, contact a qualified service engineer for further analysis</p>
ErrorSuggestion0000FF00	Please try the other motion path.
ErrorSuggestion0000FF01	<p>[Cause]Payload and speed are over specification</p> <p>[Caution]1. Check if the TCP setting of the current tool is correct</p> <p>2. Check if the payload setting on each motion node is correct</p> <p>3. Check if the speed of the current project is too fast</p> <p>[Additional Explanation] Momentum is defined as mass (tool + payload) x TCP speed</p> <p>[Additional Explanation] This error is not likely happen if both payload and speed is within specification</p> <p>[Solution]1. Press STOP button on the robot stick to restore from error status</p> <p>2. Modified the TCP settings or motion settings; or remove the payload first</p> <p>3. Run the project again; if this error still occurs, contact a qualified service engineer for further analysis</p> <p>Make sure both payload and speed is within specification</p>
ErrorSuggestion0000FF02	<p>[Cause]1. Current motion of the robot is too fast</p> <p>2. Hardware issue</p> <p>[Caution]1. Check if the TCP setting of the current tool is correct</p> <p>2. Check if the payload setting on each motion node is correct</p> <p>3. Check if the speed of the current project is too fast</p> <p>[Additional Explanation] This error does not likely happen since other error code should be triggered first, such as 0x00000049, 0x00000053, 0x00000054</p> <p>[Solution]1. Press STOP button on the robot stick to restore from error status</p> <p>2. Modified the TCP settings or motion settings; or remove the payload first</p> <p>3. Run the project again; if this error still occurs, contact a qualified service engineer for further analysis</p> <p>Make sure both payload and speed is within specification</p>
ErrorSuggestion0000FF03	Please adjust the Collaboration space.
ErrorSuggestion0000FF04	<p>[Cause]The robot detects a TCP speed which exceeds the limit of the safety settings.</p> <p>[Caution]1. Check and make sure the TCP speed limit on Settings\Safety Settings\Safety Criteria is suitable</p> <p>2. Check and make sure the TCP speed limit on Settings\Safety Settings\Collaborative Setting\More Limit Setting is suitable for Collaborative Mode</p> <p>3. Make sure the settings of TCP used are correct, especially the Pose of TCP.</p> <p>4. Check if the issued point is PTP on motion setting.</p> <p>[Additional Explanation] If the robot moves under the circumstances of singularity (both internal and external) with PTP on motion setting, that may easily cause this error.</p> <p>[Solution]To restore the robot from Error Status :</p>

1. Press the STOP button on the robot stick, or
2. Press the FREE button.
 1. Avoid postures or motion paths near singularities.
 2. Decrease the speed if you want to keep the posture or motion path smooth.
 3. Make sure the force limit value of the Safety Settings is suitable in both Manual/Auto Mode and Collaborative Mode.

ErrorSuggestion0000FF05

[Cause]The robot detects an exceeding TCP force which is over the limit of the Safety Setting.

[Caution]1. Check if the robot will collide with anything.

2. Check and make sure the TCP force limit on Settings\Safety Settings\Safety Criteria is suitable

3. Check and make sure the TCP force limit on Settings\Safety Settings\Collaborative Setting\More Limit Setting is suitable for collaborative mode

4. Make sure the settings of all TCP used are correct, including the pose of TCP, Mass, Mass Center Frame, Principal Moments of Inertia.

5. Make sure the payload setting is correct on every motion related node of the flow, e.g. Point, Move, Pallet, etc.

[Precaution] Tools with a mass center frame far from the flange will add large external torques onto the robot. Without the correct TCP settings (including, TCP pose, Mass, Mass Center Frame, Principal Moments of Inertia), the servo system would mistake this for an error.

[Additional Explanation] The result of TCP forces achieved is by calculations. This calculation will be dysfunctional when the robot passes through the singularity zone, and will mistakenly trigger this error.

[Solution]To restore the robot from Error Status :

1. Press the STOP button on the robot stick, or
2. Press the FREE button.
 1. Avoid postures or motion paths near singularities.
 2. Decrease the speed if you want to keep the posture or motion path smooth.
 3. Make sure the force limit value of the Safety Settings is suitable in both Manual/Auto Mode and Collaborative Mode.

ErrorSuggestion0000FF06

[Cause]Joint 1 Position exceeds the value of the safety setting threshold.

[Caution]1. Check that the safety threshold angle of the axis is appropriate.

2. Check that the project flow has not set a position that the TM robot cannot reach (for example, using a TM5 to run TM12 project).

[Solution]To restore the robot from error status:

1. Press the STOP button on the robot stick, or
2. Press the FREE button
 1. Set the safety threshold to a more suitable value.
 2. Revise the project flow.

ErrorSuggestion0000FF07	<p>[Cause]Joint 1 Velocity exceeds the value of the safety setting threshold.</p> <p>[Caution]1. Check that the safety threshold speed of the axis is appropriate. 2. Check the line speed setting.</p> <p>[Solution]To restore the robot from error status: 1. Press the STOP button on the robot stick, or 2. Press the FREE button.</p> <p>1. Make sure the safety settings are suitable for current application 2. Make sure the motion of the project would be trigger this error</p>
ErrorSuggestion0000FF08	<p>[Cause]Joint 1 Torque exceeds the value of the safety setting threshold. This maybe caused by:</p> <p>1. Improper payload settings 2. A collision has occurred 3. The brake is abnormal</p> <p>[Caution]1. Check that the payload setting is correct 2. Check if there has been a collision 3. Check whether the first axis brake is abnormal</p> <p>[Solution]To restore the robot from Error Status : 1. Press the STOP button on the robot stick, or 2. Press the FREE button.</p> <p>1. Make sure the payload setting or payload used is suitable 2. Make sure the safety settings are suitable for current application 3. Assess the working environment, avoid any violent collision onto the robot</p>
ErrorSuggestion0000FF09	<p>[Cause]Joint 2 Position exceeds the value of the safety setting threshold.</p> <p>[Caution]1. Check that the safety threshold angle of the axis is appropriate. 2. Check that the project flow has not set a position that the TM robot cannot reach (for example, using a TM5 to run TM12 project).</p> <p>[Solution]To restore the robot from error status: 1. Press the STOP button on the robot stick, or 2. Press the FREE button</p> <p>1. Set the safety threshold to a more suitable value. 2. Revise the project flow.</p>
ErrorSuggestion0000FF0A	<p>[Cause]Joint 2 Velocity exceeds the value of the safety setting threshold.</p> <p>[Caution]1. Check that the safety threshold speed of the axis is appropriate. 2. Check the line speed setting.</p>

	<p>[Solution]To restore the robot from error status:</p> <ol style="list-style-type: none"> 1. Press the STOP button on the robot stick, or 2. Press the FREE button. <ol style="list-style-type: none"> 1. Make sure the safety settings are suitable for current application 2. Make sure the motion of the project would be trigger this error
ErrorSuggestion0000FF0B	<p>[Cause]Joint 2 Torque exceeds the value of the safety setting threshold. This maybe caused by:</p> <ol style="list-style-type: none"> 1. Improper payload settings 2. A collision has occurred 3. The brake is abnormal <p>[Caution]1. Check that the payload setting is correct</p> <ol style="list-style-type: none"> 2. Check if there has been a collision 3. Check whether the first axis brake is abnormal
	<p>[Solution]To restore the robot from Error Status :</p> <ol style="list-style-type: none"> 1. Press the STOP button on the robot stick, or 2. Press the FREE button. <ol style="list-style-type: none"> 1. Make sure the payload setting or payload used is suitable 2. Make sure the safety settings are suitable for current application 3. Assess the working environment, avoid any violent collision onto the robot
ErrorSuggestion0000FF0C	<p>[Cause]Joint 3 Position exceeds the value of the safety setting threshold.</p> <p>[Caution]1. Check that the safety threshold angle of the axis is appropriate.</p> <ol style="list-style-type: none"> 2. Check that the project flow has not set a position that the TM robot cannot reach (for example, using a TM5 to run TM12 project).
	<p>[Solution]To restore the robot from error status:</p> <ol style="list-style-type: none"> 1. Press the STOP button on the robot stick, or 2. Press the FREE button <ol style="list-style-type: none"> 1. Set the safety threshold to a more suitable value. 2. Revise the project flow.
ErrorSuggestion0000FF0D	<p>[Cause]Joint 3 Velocity exceeds the value of the safety setting threshold.</p> <p>[Caution]1. Check that the safety threshold speed of the axis is appropriate.</p> <ol style="list-style-type: none"> 2. Check the line speed setting.
	<p>[Solution]To restore the robot from error status:</p> <ol style="list-style-type: none"> 1. Press the STOP button on the robot stick, or

	<p>2. Press the FREE button.</p> <p>1. Make sure the safety settings are suitable for current application</p> <p>2. Make sure the motion of the project would be trigger this error</p>
ErrorSuggestion0000FF0E	<p>[Cause]Joint 3 Torque exceeds the value of the safety setting threshold. This maybe caused by:</p> <p>1. Improper payload settings</p> <p>2. A collision has occurred</p> <p>3. The brake is abnormal</p> <p>[Caution]1. Check that the payload setting is correct</p> <p>2. Check if there has been a collision</p> <p>3. Check whether the first axis brake is abnormal</p> <p>[Solution]To restore the robot from Error Status :</p> <p>1. Press the STOP button on the robot stick, or</p> <p>2. Press the FREE button.</p> <p>1. Make sure the payload setting or payload used is suitable</p> <p>2. Make sure the safety settings are suitable for current application</p> <p>3. Assess the working environment, avoid any violent collision onto the robot</p>
ErrorSuggestion0000FF0F	<p>[Cause]Joint 4 Position exceeds the value of the safety setting threshold.</p> <p>[Caution]1. Check that the safety threshold angle of the axis is appropriate.</p> <p>2. Check that the project flow has not set a position that the TM robot cannot reach (for example, using a TM5 to run TM12 project).</p> <p>[Solution]To restore the robot from error status:</p> <p>1. Press the STOP button on the robot stick, or</p> <p>2. Press the FREE button</p> <p>1. Set the safety threshold to a more suitable value.</p> <p>2. Revise the project flow.</p>
ErrorSuggestion0000FF10	<p>[Cause]Joint 4 Velocity exceeds the value of the safety setting threshold.</p> <p>[Caution]1. Check that the safety threshold speed of the axis is appropriate.</p> <p>2. Check the line speed setting.</p> <p>[Solution]To restore the robot from error status:</p> <p>1. Press the STOP button on the robot stick, or</p> <p>2. Press the FREE button.</p> <p>1. Make sure the safety settings are suitable for current application</p> <p>2. Make sure the motion of the project would be trigger this error</p>

ErrorSuggestion0000FF11	<p>[Cause]Joint 4 Torque exceeds the value of the safety setting threshold. This maybe caused by:</p> <ol style="list-style-type: none"> 1. Improper payload settings 2. A collision has occurred 3. The brake is abnormal <p>[Caution]1. Check that the payload setting is correct</p> <ol style="list-style-type: none"> 2. Check if there has been a collision 3. Check whether the first axis brake is abnormal <p>[Solution]To restore the robot from Error Status :</p> <ol style="list-style-type: none"> 1. Press the STOP button on the robot stick, or 2. Press the FREE button. <ol style="list-style-type: none"> 1. Make sure the payload setting or payload used is suitable 2. Make sure the safety settings are suitable for current application 3. Assess the working environment, avoid any violent collision onto the robot
ErrorSuggestion0000FF12	<p>[Cause]Joint 5 Position exceeds the value of the safety setting threshold.</p> <p>[Caution]1. Check that the safety threshold angle of the axis is appropriate.</p> <ol style="list-style-type: none"> 2. Check that the project flow has not set a position that the TM robot cannot reach (for example, using a TM5 to run TM12 project). <p>[Solution]To restore the robot from error status:</p> <ol style="list-style-type: none"> 1. Press the STOP button on the robot stick, or 2. Press the FREE button <ol style="list-style-type: none"> 1. Set the safety threshold to a more suitable value. 2. Revise the project flow.
ErrorSuggestion0000FF13	<p>[Cause]Joint 5 Velocity exceeds the value of the safety setting threshold.</p> <p>[Caution]1. Check that the safety threshold speed of the axis is appropriate.</p> <ol style="list-style-type: none"> 2. Check the line speed setting. <p>[Solution]To restore the robot from error status:</p> <ol style="list-style-type: none"> 1. Press the STOP button on the robot stick, or 2. Press the FREE button. <ol style="list-style-type: none"> 1. Make sure the safety settings are suitable for current application 2. Make sure the motion of the project would be trigger this error
ErrorSuggestion0000FF14	<p>[Cause]Joint 5 Torque exceeds the value of the safety setting threshold. This maybe caused by:</p> <ol style="list-style-type: none"> 1. Improper payload settings 2. A collision has occurred

3. The brake is abnormal

[Caution]1. Check that the payload setting is correct

2. Check if there has been a collision

3. Check whether the first axis brake is abnormal

[Solution]To restore the robot from Error Status :

1. Press the STOP button on the robot stick, or

2. Press the FREE button.

1. Make sure the payload setting or payload used is suitable

2. Make sure the safety settings are suitable for current application

3. Assess the working environment, avoid any violent collision onto the robot

ErrorSuggestion0000FF15 [Cause]Joint 6 Position exceeds the value of the safety setting threshold.

[Caution]1. Check that the safety threshold angle of the axis is appropriate.

2. Check that the project flow has not set a position that the TM robot cannot reach (for example, using a TM5 to run TM12 project).

[Solution]To restore the robot from error status:

1. Press the STOP button on the robot stick, or

2. Press the FREE button

1. Set the safety threshold to a more suitable value.

2. Revise the project flow.

ErrorSuggestion0000FF16 [Cause]Joint 6 Velocity exceeds the value of the safety setting threshold.

[Caution]1. Check that the safety threshold speed of the axis is appropriate.

2. Check the line speed setting.

[Solution]To restore the robot from error status:

1. Press the STOP button on the robot stick, or

2. Press the FREE button.

1. Make sure the safety settings are suitable for current application

2. Make sure the motion of the project would be trigger this error

ErrorSuggestion0000FF17 [Cause]Joint 6 Torque exceeds the value of the safety setting threshold. This maybe caused by:

1. Improper payload settings

2. A collision has occurred

3. The brake is abnormal

[Caution]1. Check that the payload setting is correct

2. Check if there has been a collision

	<p>3. Check whether the first axis brake is abnormal</p> <p>[Solution]To restore the robot from Error Status :</p> <ol style="list-style-type: none"> 1. Press the STOP button on the robot stick, or 2. Press the FREE button. <ol style="list-style-type: none"> 1. Make sure the payload setting or payload used is suitable 2. Make sure the safety settings are suitable for current application 3. Assess the working environment, avoid any violent collision onto the robot
ErrorSuggestion0000FF18	Please check the safety threshold of the seventh axis angle is appropriate.
ErrorSuggestion0000FF19	Please check the safety threshold of the seventh axis speed is appropriate.
ErrorSuggestion0000FF1A	<ol style="list-style-type: none"> 1. Check whether the Payload setting is correct 2. Check whether there is a collision during the seventh axis 3. Check whether the seventh axis brake is abnormal
ErrorSuggestion0000FF20	<p>[Cause]Current for solenoid is over specification during brake release process</p> <p>[Caution]</p> <p>[Additional Explanation] System will detect the current for solenoid during brake releasing process, when it find the value over specification, it will report this error</p> <p>[Solution]1. Please press E-stop and release E-stop to resume Robot to see the issue is still occurred or not.</p> <p>2. If this still occurs, contact a qualified service engineer for further analysis</p>
ErrorSuggestion0000FF21	<p>[Cause]Joint movement range is over range during brake release process</p> <p>[Caution]Check if the payload is too that out of specification, including the mass, center of mass, inertia, etc.</p> <p>[Additional Explanation] System will detect the movement range while brake release process, when the value is over expected, it will report this error.</p> <p>[Solution]1. Power off the robot</p> <p>2. Remove all payload and restart the robot</p> <p>3. If this issue still happens, have a qualified service engineer for further analysis</p> <ol style="list-style-type: none"> 1. Make sure the payload is within specification (including the center of mass and inertia) 2. Make sure there is no unexpected force acting on the robot during brake release process
ErrorSuggestion0000FFA0	<p>[Cause]Robot detect a low voltage on DCBUS.</p> <p>[Caution]</p> <p>[Additional Explanation] There maybe a variety of reasons that cause a low voltage, for example:</p> <ol style="list-style-type: none"> 1. The power source is not stable on customer-site 2. Power supply is abnormal 3. etc. <p>[Precaution] Power off and unplug the power cable before opening the control box for items checking</p> <p>[Solution]Shut down the robot, make sure the power source is stable then power on. If the same issue still occurs,</p>

	<p>contact a qualified service engineer for further analysis</p> <p>Make sure the power source is robust for robot running.</p>
ErrorSuggestion0000FFA1	<p>[Cause]Robot detect the voltage on DCBUS is higher than spec.</p> <p>[Caution]Check whether there are others error log along with this error.</p> <p>[Additional Explanation] There maybe a variety of reasons that cause a high voltage, for example:</p> <ol style="list-style-type: none"> 1. The robot move too fast with the current project (with heavy payload) 2. Power eater modules is abnormal 3. etc. <p>[Precaution] Power off and unplug the power cable before opening the control box for items checking</p> <p>[Solution]After restart the robot, the problem still occur, contact a qualified service engineer for further analysis</p> <ol style="list-style-type: none"> 1. Make sure the robot would not be collided and be placed on an unstable platform. 2. Make sure project speed with payload is within the specification.
ErrorSuggestion0000FFA2	Be careful! G sensor overload on X direction.
ErrorSuggestion0000FFA3	Be careful! G sensor overload on Y direction.
ErrorSuggestion0000FFA4	Be careful! G sensor overload on Z direction.
ErrorSuggestion0000FFA5	<p>[Cause]Robot detect the temperature on PCB is higher than spec.</p> <p>[Caution]1. Check if the environment temperature is higher than the spec. while robot moving.</p> <p>2. Check the temperature on View->Status</p> <p>[Additional Explanation] The temperature would rise during robot operating and the work space temperature will affect as well.</p> <p>[Solution]Shut down the robot, and keep it cool for a while before start up again. If this issue still occurs, please contact a qualified service engineer for further analysis</p> <ol style="list-style-type: none"> 1. Make sure the temperature of the working environment is within the specification. 2. Make sure the payload or the project speed is within the specification
ErrorSuggestion0000FFA6	<p>[Cause]Robot has detected a overshoot of U phase current on the motor</p> <p>[Caution]1. Check the header of the error code to see which motor is with this issue</p> <p>2. Check if the robot is run with payload out of spec. and also in high speed</p> <p>3. Check if the safety settings of the robot</p> <p>[Additional Explanation] If the robot is driven and accelerate fast, current of the motor will overshoot and trigger this error</p> <p>[Additional Explanation] This is usually be triggered when running the robot with a heavy payload with high speed which is nearly or already out of spec.</p> <p>[Additional Explanation] Another reason may be there is dysfunction on the electronics on the motors</p> <p>[Solution]1. Shut down and reboot the robot</p> <p>2. Adjust the payload, safety settings, speed and see if the issue still happens</p> <p>3. If it still happens, export the Logs, Project and TCP used, and contact to your service engineer</p>

ErrorSuggestion0000FFA7	<ol style="list-style-type: none"> 1. Make sure the payload (including the tool) is within the spec. 2. Adjust the speed or movement to prevent the risk of having a single joint accelerate too fast <p>[Cause]Robot has detected a overshoot of V phase current on the motor</p> <p>[Caution]1. Check the header of the error code to see which motor is with this issue</p> <ol style="list-style-type: none"> 2. Check if the robot is run with payload out of spec. and also in high speed 3. Check if the safety settings of the robot <p>[Additional Explanation] If the robot is driven and accelerate fast, current of the motor will overshoot and trigger this error</p> <p>[Additional Explanation] This is usually be triggered when running the robot with a heavy payload with high speed which is nearly or already out of spec.</p> <p>[Additional Explanation] Another reason may be there is dysfunction on the electronics on the motors</p> <p>[Solution]1. Shut down and reboot the robot</p> <ol style="list-style-type: none"> 2. Adjust the payload, safety settings, speed and see if the issue still happens 3. If it still happens, export the Logs, Project and TCP used, and contact to your service engineer
ErrorSuggestion0000FFA8	<ol style="list-style-type: none"> 1. Make sure the payload (including the tool) is within the spec. 2. Adjust the speed or movement to prevent the risk of having a single joint accelerate too fast <p>[Cause]Robot has detected a overshoot of W phase current on the motor</p> <p>[Caution]1. Check the header of the error code to see which motor is with this issue</p> <ol style="list-style-type: none"> 2. Check if the robot is run with payload out of spec. and also in high speed 3. Check if the safety settings of the robot <p>[Additional Explanation] If the robot is driven and accelerate fast, current of the motor will overshoot and trigger this error</p> <p>[Additional Explanation] This is usually be triggered when running the robot with a heavy payload with high speed which is nearly or already out of spec.</p> <p>[Additional Explanation] Another reason may be there is dysfunction on the electronics on the motors</p> <p>[Solution]1. Shut down and reboot the robot</p> <ol style="list-style-type: none"> 2. Adjust the payload, safety settings, speed and see if the issue still happens 3. If it still happens, export the Logs, Project and TCP used, and contact to your service engineer
ErrorSuggestion0000FFA9	Be careful! Motor current protection on U phase triggered, which may be caused by impact.
ErrorSuggestion0000FFAA	Be careful! Motor current protection on V phase triggered, which may be caused by impact.
ErrorSuggestion0000FFAB	<p>[Cause]The motor current rises suddenly and triggers motor hold protection</p> <p>[Caution]1. Check if there robot has collided to the surroundings seriously</p> <ol style="list-style-type: none"> 2. Check the description of this error code to see which joint it belongs to <p>[Additional Explanation] When the robot collides to a solid object in a high speed, some of the joints may suffer a</p>

great torque on them and this causes the motor current raise rapidly and trigger this error

[Precaution] If the robot is closed to any thing or surface, using ordinary start-up may cause collision again during the joint calibration; therefore, use should use Safe Start-up Mode to restore the robot

[Precaution] When manually driving the robot in Safe Start-up Mode, there is no drive power but just release the brakes of all joints, if there is tool or payload on the end-effector, it is suggest to have more than one person to hold the end-effector.

[Precaution] Do not drive the joint manually when this error occurs, which might damage the joint

[Solution]1. Trigger the Emergency Switch (Button) and then shutdown the robot

2. Reboot the robot

3. Release the Emergency Switch (Button) when the Control Box starts working

4. The system will enter Safe Start-up Mode (light blue on LED)

5. Press FREE button and drive the robot to a safe region or pose

6. Hold the STOP button of the robot stick and switch the system to AUTO mode

Make sure the robot will not collide with the surroundings during project run

ErrorSuggestion0000FFAC An error occurred in the UVW signal on optical encoder

ErrorSuggestion0000FFAD The index of encoder is not calibrated.

ErrorSuggestion0000FFAE [Cause]Robot has detected the current on DCBUS went too high suddenly.

[Caution]1. The speed(ABS/project speed) is too fast.

2. Check whether there is any collision while robot moving.

[Additional Explanations] If robot is moving in a high speed in some movement or pose, it would cause this error.

And if robot has collisions, it would cause the current became abnormal.

[Solution][General User] After restart the robot, the problem still occur, contact a qualified service engineer for further analysis.

1.Slow down the speed(ABS/project speed).

2. Avoid any collision while robot is moving.

ErrorSuggestion0000FFAF [Cause]The communication time of EtherCAT is timeout

[Caution]Check if any external EtherCAT device used has lost connection

[Additional Explanation] System will periodic check the EtherCAT communication, if communication timeout, it will report this error.

[Solution]Contact a qualified service engineer for further analysis

external

ErrorSuggestion0000FFB1 [Cause]The communication time of SPI is timeout

[Caution]

[Additional Explanation] It may possibly because the SPI IC is dysfunction which is not likely to happen

[Solution]

ErrorSuggestion0000FFB2 1. Please check grounding line is normal or not.

	2. Please contact the original purchase of the manufacturer or a third party designated maintenance unit.
ErrorSuggestion0000FFB3	Please contact the original purchase of the manufacturer or a third party designated maintenance unit.
ErrorSuggestion0000FFB4	1. Please try to restart the robot. 2. If the restart is invalid, please contact the original purchase or third-party designated maintenance units.
ErrorSuggestion0000FFB5	1. Please try to restart the robot. 2. If the restart is invalid, please contact the original purchase or third-party designated maintenance units.
ErrorSuggestion0000FFB6	Please contact the original purchase of the manufacturer or a third party designated maintenance unit.
ErrorSuggestion0000FFB7	Please check the functionality of break unit
ErrorSuggestion0000FFB8	[Cause]Hardware Failure [Caution] [Additional Explanation] This error is not likely happens, mostly because of hardware issue [Solution]1. Export the Logs 2. Contact a qualified service engineer for further analysis
ErrorSuggestion0000FFB9	[Cause]Hardware Failure [Caution] [Additional Explanation] This error is not likely happens, mostly because of hardware issue [Solution]1. Export the Logs 2. Contact a qualified service engineer for further analysis
ErrorSuggestion0000FFBA	[Cause]Hardware Failure [Caution] [Restriction] Do not drive the joint with or without drive power [Solution]1. Export the Logs 2. Contact a qualified service engineer for further analysis Make sure the power source is robust for robot running.
ErrorSuggestion0000FFC0	An error occurred in transit to absolute position
ErrorSuggestion0000FFC1	Please contact the original purchase of the manufacturer or a third party designated maintenance unit.
ErrorSuggestion0000FFC2	Please contact the original purchase of the manufacturer or a third party designated maintenance unit.
ErrorSuggestion0000FFC3	Please contact the original purchase of the manufacturer or a third party designated maintenance unit.
ErrorSuggestion0000FFC4	Please contact the original purchase of the manufacturer or a third party designated maintenance unit.
ErrorSuggestion0000FFC5	Please contact the original purchase of the manufacturer or a third party designated maintenance unit.
ErrorSuggestion0000FFC6	Please contact the original purchase of the manufacturer or a third party designated maintenance unit.
ErrorSuggestion0000FFC7	Please contact the original purchase of the manufacturer or a third party designated maintenance unit.
ErrorSuggestion0000FFC8	Please contact the original purchase of the manufacturer or a third party designated maintenance unit.
ErrorSuggestion0000FFC9	Please contact the original purchase of the manufacturer or a third party designated maintenance unit.
ErrorSuggestion0000FFCA	[Cause]Encoder is dysfunctional [Caution]

	<p>[Additional Explanation] This error is not likely happens, mostly because of hardware issue</p> <p>[Solution]1. Export the log,</p> <p>2. Contact a qualified service engineer for further analysis</p>
ErrorSuggestion0000FFCB	Please reduce the motion speed, check the flow and the speed and posture in each node
ErrorSuggestion0000FFCC	<p>[Cause]Encoder is dysfunctional</p> <p>[Caution]</p> <p>[Additional Explanation] This error is not likely happens, mostly because of hardware issue</p> <p>[Solution]1. Export the log,</p> <p>2. Contact a qualified service engineer for further analysis</p>
ErrorSuggestion0000FFCD	<p>[Cause]Hardware Failure</p> <p>[Caution]</p> <p>[Restriction] Do not drive the joint with or without drive power when this issue happens</p> <p>[Solution]1. Export the Logs</p> <p>2. Contact a qualified service engineer for further analysis</p> <p>Make sure the robot would not collided with the surroundings during project run or robot shifting</p>
ErrorSuggestion0000FFCE	<p>[Cause]Hardware Failure</p> <p>[Caution]</p> <p>[Restriction] Do not drive the joint with or without drive power</p> <p>[Solution]1. Export the Logs</p> <p>2. Contact a qualified service engineer for further analysis</p>
ErrorSuggestion0000FFCF	<p>[Cause]The motor current rises suddenly and triggers motor hold protection</p> <p>[Caution]1. Check if there robot has collided to the surroundings seriously</p> <p>2. Check the description of this error code to see which joint it belongs to</p> <p>[Additional Explanation] When the robot collides to a solid object in a high speed, some of the joints may suffer a great torque on them and this causes the motor current raise rapidly and trigger this error</p> <p>[Precaution] If the robot is closed to any thing or surface, using ordinary start-up may cause collision again during the joint calibration; therefore, use should use Safe Start-up Mode to restore the robot</p> <p>[Precaution] When manually driving the robot in Safe Start-up Mode, there is no drive power but just release the brakes of all joints, if there is tool or payload on the end-effector, it is suggest to have more than one person to hold the end-effector.</p> <p>[Precaution] Do not drive the joint manually when this error occurs, which might damage the joint</p> <p>[Solution]1. Trigger the Emergency Switch (Button) and then shutdown the robot</p> <p>2. Reboot the robot</p> <p>3. Release the Emergency Switch (Button) when the Control Box starts working</p> <p>4. The system will enter Safe Start-up Mode (light blue on LED)</p> <p>5. Press FREE button and drive the robot to a safe region or pose</p>

	6. Hold the STOP button of the robot stick and switch the system to AUTO mode Make sure the robot will not collide with the surroundings during project run
ErrorSuggestion0000FFD0	Please check the UVW signal on encoder
ErrorSuggestion0000FFD1	[Cause]Hardware Failure [Caution]Check if the robot is placed near any device with strong magnetic field [Additional Explanation] Under a strong magnetic field may affect the readings of the magnetic encoder [Solution]1. Export the Logs 2. Make sure the robot is not under any strong magnetic field and then reboot the robot 3. If this still does not work, Contact a qualified service engineer for further analysis Make sure the robot is not under any strong magnetic field
ErrorSuggestion0000FFD2	[Cause]Hardware Failure [Caution]Check if the robot is placed near any device with strong magnetic field [Additional Explanation] Under a strong magnetic field may affect the readings of the magnetic encoder [Solution]1. Export the Logs 2. Make sure the robot is not under any strong magnetic field and then reboot the robot 3. If this still does not work, Contact a qualified service engineer for further analysis Make sure the robot is not under any strong magnetic field
ErrorSuggestion0000FFD3	[Cause]1.The robot may be disassembled abnormally. Please check the warranty sticker and thread-locking fluid are both broken or not 2. Joint gear wear out [Caution] [Additional Explanation] When the origin of joint module is not detected, it will report this error [Solution]1. Export the log file 2. Contact a qualified service engineer
ErrorSuggestion0000FFD4	Please contact the original purchase of the manufacturer or a third party designated maintenance unit.
ErrorSuggestion0000FFD5	Please contact the original purchase of the manufacturer or a third party designated maintenance unit.
ErrorSuggestion0000FFD6	Please contact the original purchase of the manufacturer or a third party designated maintenance unit.
ErrorSuggestion0000FFD7	Please contact the original purchase of the manufacturer or a third party designated maintenance unit.
ErrorSuggestion0000FFD8	[Cause]1. Motor is damaged 2. Joint PCB is damaged [Caution] [Additional Explanation] When the resistance of UVW current of motor is abnormal, it will report this error [Solution]1. Export the log file 2. Contact a qualified service engineer
ErrorSuggestion0000FFD9	[Cause]Hardware Failure [Caution]

	<p>[Additional Explanation] The cables connection sequence of UVW of motor is not correct. Quality issue or the robot may be disassembled abnormally.</p> <p>[Solution]1. Export the log file</p> <p>2. Contact a qualified service engineer</p> <p>Make sure the robot is not being disassembled illegally</p>
ErrorSuggestion0000FFDA	Please contact the original purchase of the manufacturer or a third party designated maintenance unit.
ErrorSuggestion0000FFDB	Please contact the original purchase of the manufacturer or a third party designated maintenance unit.
ErrorSuggestion0000FFDC	Please contact the original purchase of the manufacturer or a third party designated maintenance unit.
ErrorSuggestion0000FFDD	<p>1. Please restart the robot.</p> <p>2. If the restart is invalid, please contact the original purchase or third-party designated maintenance units.</p>
ErrorSuggestion0000FFDE	<p>1. Please restart the robot.</p> <p>2. If the restart is invalid, please contact the original purchase or third-party designated maintenance units.</p>
ErrorSuggestion0000FFDF	<p>1. Please restart the robot.</p> <p>2. If the restart is invalid, please contact the original purchase or third-party designated maintenance units.</p>
ErrorSuggestion0000FFE0	<p>[Cause]1. Power supply is not stable.</p> <p>2. Robot moves in high speed, current is higher, voltage loss getting higher.(Vinput-Vloss=V for DC bus)</p> <p>3. Power connector problem, consume too much power</p> <p>[Caution]</p> <p>[Additional Explanation] When robot is working and detects the voltage of DC bus is low, it will report this error</p> <p>[Solution]1. Power off the robot</p> <p>2. Check Robot Cable and its connector before power on again</p> <p>3. Reduce Robot speed if necessary</p> <p>Make sure power source is stable</p>
ErrorSuggestion0000FFE1	Please contact the original purchase of the manufacturer or a third party designated maintenance unit.
ErrorSuggestion0000FFE2	<p>1. Please restart the robot.</p> <p>2. If the restart is invalid, please contact the original purchase or third-party designated maintenance units.</p>
ErrorSuggestion0000FFE3	<p>1. Please restart the robot.</p> <p>2. If the restart is invalid, please contact the original purchase or third-party designated maintenance units.</p>
ErrorSuggestion0000FFE4	<p>[Cause]Encoder is abnormal</p> <p>[Caution]</p> <p>[Additional Explanation] This error is not likely happens, mostly because of hardware issue</p> <p>[Solution]1. Export the log,</p> <p>2. Contact a qualified service engineer for further analysis</p>
ErrorSuggestion0000FFE5	<p>1. Please restart the robot.</p> <p>2. If the restart is invalid, please contact the original purchase or third-party designated maintenance units.</p>
ErrorSuggestion0000FFE6	1. Please restart the robot.

	2. If the restart is invalid, please contact the original purchase or third-party designated maintenance units.
ErrorSuggestion0000FFE7	Please contact the original purchase of the manufacturer or a third party designated maintenance unit.
ErrorSuggestion0000FFE8	[Cause]Hardware Failure [Caution] [Additional Explanation] When the output of the G sensor is abnormal, it will report this error [Solution]1. Export the log file 2. Contact a qualified service engineer
ErrorSuggestion0000FFE9	Please contact the original purchase of the manufacturer or a third party designated maintenance unit.
ErrorSuggestion0000FFEA	[Cause]DC to DC component on Join PCB is damaged [Caution] [Additional Explanation] When detect voltage of 5V is abnormal, it will report this error [Solution]
ErrorSuggestion0000FFEB	[Cause]DC to DC component on Join PCB is damaged [Caution] [Additional Explanation] When detect voltage of 12V is abnormal, it will report this error [Solution]
ErrorSuggestion0000FFEC	Please contact the original purchase of the manufacturer or a third party designated maintenance unit.
ErrorSuggestion0000FFED	[Cause]Encoder is msyfunction [Caution] [Additional Explanation] This error is not likely happens, mostly because of hardware issue [Solution]1. Export the log, 2. Contact a qualified service engineer for further analysis
ErrorSuggestion0000FFEE	Please turn on joint modules
ErrorSuggestion0000FFEF	Please contact the original purchase of the manufacturer or a third party designated maintenance unit.
ErrorSuggestion00013880	Mathematical operation failed! Please contact the original purchase of the manufacturer or a third party designated maintenance unit.
ErrorSuggestion00013881	Mathematical operation failed! Please contact the original purchase of the manufacturer or a third party designated maintenance unit.
ErrorSuggestion00013882	Mathematical operation failed! Please contact the original purchase of the manufacturer or a third party designated maintenance unit.
ErrorSuggestion00013883	Mathematical operation failed! Please contact the original purchase of the manufacturer or a third party designated maintenance unit.
ErrorSuggestion00013884	Mathematical operation failed! Please contact the original purchase of the manufacturer or a third party designated maintenance unit.
ErrorSuggestion00013885	Mathematical operation failed! Please contact the original purchase of the manufacturer or a third party designated maintenance unit.

ErrorSuggestion000153E2	Mathematical operation failed! Please contact the original purchase of the manufacturer or a third party designated maintenance unit.
ErrorSuggestion000153E3	Mathematical operation failed! Please contact the original purchase of the manufacturer or a third party designated maintenance unit.
ErrorSuggestion000157C0	Mathematical operation failed! Please contact the original purchase of the manufacturer or a third party designated maintenance unit.
ErrorSuggestion000157C1	Mathematical operation failed! Please contact the original purchase of the manufacturer or a third party designated maintenance unit.
ErrorSuggestion00020000	<p>[Cause] The robot can not detect or recognize the camera.</p> <p>[Caution]1. Check if there is a camera icon in the vision job page.</p> <p>2. Check whether the USB connection of the camera is broken on the control box or inside the robot arm.</p> <p>[Precaution] Causes a camera malfunction and VISION job/task will not be available.</p> <p>[Precaution] Importing the project within the vision job to a non-vision robot will also cause this error.</p> <p>[Solution]Refer to the related service manual for proper USB plugin methods.</p> <p>Ensure that all USB cables are securely connected to the camera and the control box.</p>
ErrorSuggestion00020001	The camera is busy when the flow try to use it. Check the flow where user may misuse multi-thread flow to use the sample camera.
ErrorSuggestion00020002	Unexpected errors occurred. Reboot the robot and try to use fewer or simpler vision jobs. If it keeps happening, please contact your support windows.
ErrorSuggestion00020003	<p>[Cause] The connection between camera and robot is unstable.</p> <p>[Caution]1. Check the USB connection to the camera and control box is secure.</p> <p>2. Check if the USB slots are overloaded.</p> <p>[Precaution] Causes a camera malfunction and VISION job/task will not be available.</p> <p>[Precaution] The USB cable's transmission signal would become weak gradually because of the normal consumption of wire.</p> <p>[Additional Explanations] Signal attenuation cause by too many USB cable plug on the control box.</p> <p>Sometimes, if the signal attenuation became worse it will cause the error "0x00020000 Camera NOT found "</p> <p>[Solution]1. Please refer to the service manual which related Robot arm which would teach you how to dismantle and plug the USB cable properly.</p> <p>2. Please refer to the service manual which related control box which would teach you how to plug the USB cable properly.</p> <p>3. Please check the USB slots are overloaded on the control box and please plug out the USB which is not</p>

	required.
	Please regularly check if the USB Cable connected to the camera and control box are all fine.
ErrorSuggestion00020004	The vision job is not compatible to the current version of HMI.
ErrorSuggestion00020005	[Cause]Dongle key is not detected while edit the corresponding function on a project or run that project [Caution]Check if the dongle is plugged onto the Control Box [Solution]1. Press STOP button on the robot stick to restore from error status 2. Connect the corresponding Dongle onto the Control box and run the project again 3. Run the project again; if this error still occurs, contact a qualified service engineer for further analysis Make sure having the corresponding Dongle key plugged before running or editing the project with license functions
ErrorSuggestion00020006	This message is only for TM's production line.
ErrorSuggestion00020007	Error occurs in the flow of vision's designer. Try to re-edit the vision job. If it keeps happening, please contact our official windows.
ErrorSuggestion00020008	[Cause]Vision job can not be found during executing the VISION node [Caution]Check if the vision job is exist or not. [Solution]1. Press STOP button on the robot stick and 2. Re-create the vision job Make sure the vision job is exist before executes the project.
ErrorSuggestion00020009	[Cause]The same camera is simultaneously accessed by multiple threads. [Caution]Check if there are multi- threads using the same camera while running the project. [Solution]Press STOP button on the robot stick to stop the project. Make sure a camera is being used by only one thread
ErrorSuggestion0002000A	This job can only be run on X64 platform
ErrorSuggestion0002000B	Servoing and Vision-IO threads conflict
ErrorSuggestion00030001	[Cause]Points setting error during creating a plane for Operation Space [Caution]Check if more than 2 of the three points of the plane are the same [Additional Explanation] A plane could only be created by 3 different points [Solution]To restore the robot from Error Status : 1. Click on the OK button on the pop up windows. 2. Reset the 3 points in following steps:

	Setting > Operation Space > Select project name of plane > Set Point
	Before creating a plane, make sure the 3 points are set well, and should not be repeated.
ErrorSuggestion00030002	[Cause]Points setting error during creating a cube for Operation Space [Caution]Check if more than 2 of the four points of the cube are the same [Additional Explanation] A cube could only be created by 4 different points [Solution]To restore the robot from Error Status : 1. Click on the OK button on the pop up windows. 2. Reset the 4 points in following steps: Setting > Operation Space > Select project name of cube > Set Point Before creating a cube, make sure the 4 points are set well, and should not be repeated.
ErrorSuggestion00030003	[Cause]The system fails to combine this plane with other planes. [Caution]Check if the three points set by the user when adding this plane, the center point of the circle falls on the outside of plane. [Solution]Re-create a plane which is suitable Check if the three points are set up when adding this plane, the center point of the circle falls on the inside of plane.
ErrorSuggestion00030004	[Cause]The system fails to combine this stop plane with other planes. [Caution]Check if the three points set by the user when adding this stop plane, the center point of the circle falls on the outside of plane. [Solution]Re-create a stop plane which is suitable Check if the three points are set up when adding this stop plane, the center point of the circle falls on the inside of plane.
ErrorSuggestion00030005	Re-Build Safety Space
ErrorSuggestion00030006	Please contact the original purchase of the manufacturer or a third party designated maintenance unit.
ErrorSuggestion00030007	N/A
ErrorSuggestion00031000	[Cause]The 3D Viewer function has been terminated [Caution]Check any 3D viewer on TMflow (such as Setting/Controller) if it is functional [Additional Explanation] This error does not likely happen unless there is a software issue [Solution]1. Export the log 2. Have the robot power cycling to see if this error still occurs 3. Report to the service engineer with the log file
ErrorSuggestion00031001	Please contact the original purchase of the manufacturer or a third party designated maintenance unit.
ErrorSuggestion00031002	Please contact the original purchase of the manufacturer or a third party designated maintenance unit.

ErrorSuggestion00031003	Please contact the original purchase of the manufacturer or a third party designated maintenance unit.
ErrorSuggestion00031004	Please contact the original purchase of the manufacturer or a third party designated maintenance unit.
ErrorSuggestion00031005	Invalid point for collision check node
ErrorSuggestion00031006	Invalid parameter for collision check node
ErrorSuggestion00031007	Over angle limit for collision check node
ErrorSuggestion00040000	<ol style="list-style-type: none"> 1. Please try to restart the robot. 2. If the restart is invalid, please contact the original purchase or third-party designated maintenance units.
ErrorSuggestion00040001	<ol style="list-style-type: none"> 1. Please backup the HMI Log. 2. Please contact the original purchase of the manufacturer or a third party designated maintenance unit.
ErrorSuggestion00040002	<ol style="list-style-type: none"> 1. Please backup the HMI Log. 2. Please contact the original purchase of the manufacturer or a third party designated maintenance unit.
ErrorSuggestion00040003	<ol style="list-style-type: none"> 1. Please backup the HMI Log. 2. Please contact the original purchase of the manufacturer or a third party designated maintenance unit.
ErrorSuggestion00040004	<ol style="list-style-type: none"> 1. Please backup the HMI Log. 2. Please contact the original purchase of the manufacturer or a third party designated maintenance unit.
ErrorSuggestion00040005	<p>[Cause]The HMI found that an unexpected exception error.</p> <p>[Caution]1. Check if there is other error message describe the location of the issue node 2. Check if there is other error message describe more detail of this issue</p> <p>[Additional Explanation] This error usually happens if there is an unexpected software issue</p> <p>[Solution]1. Export the log file and the project file 2. Contact a qualified service engineer</p>
ErrorSuggestion00040006	<ol style="list-style-type: none"> 1. Please backup the HMI Log. 2. Please contact the original purchase of the manufacturer or a third party designated maintenance unit.
ErrorSuggestion00040007	<p>[Cause]ESTOP mode is triggered, and the power of the robot is cut off. HMI can't connect the robot.</p> <p>[Caution]Check if ESTOP mode is triggered :</p> <ol style="list-style-type: none"> 1. The ESTOP button of the stick is pressed. 2. The ESTOP wire of the control box is not connected. <p>Check if the LED light of the robot is turn off.</p> <p>[Additional Explanation] This error usually appears as a popped up message on HMI</p> <p>[Additional Explanation] This error usually happens because the power of the robot is cut off by ESTOP mode triggered while doing the one of the following cases:</p> <ol style="list-style-type: none"> 1. When open and close the camera IO LED, the HMI will pop up a window message 「 Robot is not connected」 2. In Project, click the "Step Run" button, the HMI will pop up a window message 「 Set Speed Fail :Robot is not connected」 3. Leave the project and enter the project again, the HMI will pop up a window message 「 error code : Robot is

not connected」

4. etc.

[Solution]If the emergency stop button has been pressed on the robot stick:

1. Release the e-stop button.
 - a. The robot mode indicator lights will blink red.
 - b. After a few seconds, the robot mode indicator will blink light blue, indicating the robot has entered safe start-up mode.

If an external emergency stop button has been pressed:

1. Release the external e-stop button.
 - a. The robot mode indicator lights will blink red.
 - b. After a few seconds, the robot mode indicator will blink light blue, indicating the robot has entered safe start-up mode.

If an one of the emergency stop ports has been tripped:

1. Plug the wire back to the port.
2. Press, then release the external emergency stop button.
 - a. The robot mode indicator lights will blink red.
 - b. After a few seconds, the robot mode indicator will blink light blue, indicating the robot has entered safe start-up mode.

Make sure the robot is connected while using HMI

ErrorSuggestion00040008 Please confirm user permissions.

ErrorSuggestion00040009 Please check whether the user account, password are correct.

ErrorSuggestion0004000A [Cause]ESTOP mode is triggered, and the power of the robot is cut off. HMI can't connect the robot.

[Caution]Check if ESTOP mode is triggered :

1. The ESTOP button of the stick is pressed.
2. The ESTOP wire of the control box is not connected.

Check if the LED light of the robot is turn off.

[Additional Explanation] This error usually appears as a popped up message in HMI

[Additional Explanation] This error usually happens because the power of the robot is cut off by ESTOP mode triggered.

1. When operator the controller ,the HMI will pop up a window message 「System fault: Lock Robot{{0}}」

[Solution]If the emergency stop button has been pressed on the robot stick:

1. Release the e-stop button.
 - a. The robot mode indicator lights will blink red.
 - b. After a few seconds, the robot mode indicator will blink light blue, indicating the robot has entered safe start-up mode.

If an external emergency stop button has been pressed:

1. Release the external e-stop button.
 - a. The robot mode indicator lights will blink red.
 - b. After a few seconds, the robot mode indicator will blink light blue, indicating the robot has entered safe start-up mode.

If an one of the emergency stop ports has been tripped:

1. Plug the wire back to the port.
2. Press, then release the external emergency stop button.
 - a. The robot mode indicator lights will blink red.
 - b. After a few seconds, the robot mode indicator will blink light blue, indicating the robot has entered safe start-up mode.

Make sure the robot is connected while using HMI

- ErrorSuggestion0004000B
1. Please reboot robot and try to set it again.
 2. If the restart is invalid, please contact the original purchase or third-party designated maintenance units.

- ErrorSuggestion0004000C
1. Please check whether the setting of TCP is correct.
 2. If the restart is invalid, please contact the original purchase or third-party designated maintenance units.

- ErrorSuggestion0004000D
1. Please backup the HMI Log.
 2. Please contact the original purchase of the manufacturer or a third party designated maintenance unit.

ErrorSuggestion0004000E Please check whether the robot is running and try it again.

ErrorSuggestion0004000F [Cause]The project is broken or does not exists.

[Caution]Check the project list again whether the project is not existing.

[Precaution] This error would only show on the pop up window, not in the HMI log.

[Solution]To restore the robot from Error Status :

Click on the OK button on the pop up window.

Make sure project is exported successfully before un-plug the usb drive

ErrorSuggestion00040010 Please check whether the component exists or is damaged.

ErrorSuggestion00040011 [Cause]The current node has not been set up correctly

[Caution]1. Check if the issued node is grey in color which means it is still in offline mode

2. Check if the setting of the current node is abnormal

[Additional Explanation] Motion related node built by TMFlow Editor has no position information which need further set up on a robot

[Solution]1. Press Stop Button on the robot stick to restore the error status

2. Complete the set up of the current node

1. Make sure all motion related nodes built from TMFlow Editor has complete settings before step run

2. Make sure all nodes of the project has been set up correctly

ErrorSuggestion00040012 Please check whether the coordinate system settings are correct and complete.

ErrorSuggestion00040013	<p>[Cause]When the TCP data is lost, or the servo check and the TCP data exchange error occurred.</p> <p>[Caution]Check if the TCP Setting UI could open that TCP</p> <p>[Solution]1. Import the project or TCP data again or 2. Re-et the TCP settings</p> <p>1.Make sure the USB devices and import process are stable during importing project and TCP data. 2.Check if the TCP data is existed before uses it.</p>
ErrorSuggestion00040014	<p>[Cause]System has detected settings of the certain node is invalid</p> <p>[Caution]1. Check the error message followed and locate the issued node 2. Check if the issued node is grey in color which means it is still in offline mode 3. Check if the setting of any nodes is abnormal</p> <p>[Additional Explanation] Motion related node built by TMFlow Editor has no position information which need further set up on a robot</p> <p>[Solution]1. Click Stop on the robot stick to restore the error status 2. Complete the set up of the current node</p> <p>1. Make sure all motion related nodes built from TMFlow Editor has complete settings before project run 2. Make sure all nodes of the project has been set up correctly</p>
ErrorSuggestion00040015	<p>[Cause]System has detected a dysfunction on the CPU Fan</p> <p>[Caution]Check if there is any werid noise coming from the Control box</p> <p>[Additional Explanation] If CPU fan is being stuck or the power cable of the fan is loosen, this error might happen</p> <p>[Solution]Contact a qualified service engineer for further analysis</p> <p>Make sure the robot is installed on a stable platform</p>
ErrorSuggestion00040016	<p>[Cause] Input the invalid value in the field in user setting.</p> <p>[Caution]Check if</p> <p>1. The Field of setting is empty 2. The format type of value in the field is invalid</p> <p>[Additional Explanation]</p> <p>This error usually appears as an pop up window when using,</p> <p>1. HMI Setting Page 2. Project Flow</p> <p>[Solution]Click OK and close the pop up window</p> <p>Make sure the value in the field is valid during setting</p>
ErrorSuggestion00040017	<p>Please check whether the coordinate system settings are correct and complete.</p>
ErrorSuggestion00040018	<p>[Cause]The base is currently used by other nodes, deleting this base will trigger this error</p> <p>[Caution]Check if the base is currently used by any nodes</p>

	<p>[Additional Explanations] The base is currently used by other nodes (POINTS, NEW BASE, etc.) , deleting this base will trigger this error</p> <p>[Additional Explanation] This error code will only appears on HMI as a pop up window</p> <p>[Solution]To restore the robot from Error Status :</p> <p>Click on the OK button on the pop up window.</p> <p>Make sure the base is not being used by any nodes before deleting it</p>
ErrorSuggestion00040019	<ol style="list-style-type: none"> 1. Check that the Point is present. 2. Check that the Point setting is abnormal.
ErrorSuggestion0004001A	<ol style="list-style-type: none"> 1. Please backup the HMI Log. 2. Please contact the original purchase of the manufacturer or a third party designated maintenance unit.
ErrorSuggestion0004001B	<ol style="list-style-type: none"> 1. Please backup the HMI Log. 2. Please contact the original purchase of the manufacturer or a third party designated maintenance unit.
ErrorSuggestion0004001C	<p>[Cause]There is no nodes connected to the Start Node in the Project Flow</p> <p>[Caution]1. Check if there is no nodes connected to the Start Node in the Project Flow</p> <p>[Solution]1. To restore the robot from Error Status :</p> <p>Press the STOP button on the robot stick, or press the FREE button.</p> <ol style="list-style-type: none"> 2. Connect the next process Node to the Start Node <p>Be careful when editing Project Flow</p>
ErrorSuggestion0004001D	Please check whether the coordinate system settings are correct and complete.
ErrorSuggestion0004001E	<p>[Cause]user account has already been login by other client device</p> <p>[Caution]Check if someone else has already login with the same account</p> <p>[Additional Explanation] This error is not likely happens, instead, 0x00040009 (Log In/Out failed) is more often.</p> <p>[Solution]Click OK and close the pop up window</p> <p>Make sure you are the only one use this account while logging in</p>
ErrorSuggestion0004001F	<p>[Cause]Another account gets the Control ownership</p> <p>[Caution]Check if there is someone else get the Control ownership with another account</p> <p>[Additional Explanation] This could only happen if multiple accounts try to get the Control ownership at the same time (nearly)</p> <p>[Additional Explanation] Usually, if one account has already get the Control ownership, the ownership button on other accounts would disable</p> <p>[Solution]1. Have the current ownership account release the control first</p> <ol style="list-style-type: none"> 2. Try getting the Control ownership again <p>Make sure only one account would get the Control ownership at once</p>

ErrorSuggestion00040020	Please confirm user permissions.
ErrorSuggestion00040021	<p>[Cause]If user edit an exist base which using "by pointing 3 points" function in Base Manager without manual teaching and click OK directly, it might cause this error.</p> <p>[Caution]In "Build a Base by 3 points" page, if user did not teach the one of three axis direction in the both option "Point on X axis" and "Point on Surface".</p> <p>[Additional Explanations] User must to choose and teach one of three axis direction(X,Y,Z) in the settings "Point on X axis" and "Point on Surface".</p> <p>[Solution]To restore the robot from Error Status :</p> <p>Click on the OK button on the pop up windows.</p> <p>Check the base is set correctly by manual operation in the "by pointing 3 points" function page .</p>
ErrorSuggestion00040022	<p>[Cause]Teach points in Compliance or Touch Stop node are not able to generate a legal motion</p> <p>[Caution]In Compliance or Touch Stop Node, check if the teach points are at the same position or impossible to generate a legal motion</p> <p>[Precaution] This error would only show the "Calculation failed" on the pop up window, not in the HMI log.</p> <p>[Solution]Click on the OK and close the pop window</p> <p>Make sure the teach points are all suitable and correct.</p>
ErrorSuggestion00040023	<p>[Cause]Teach points in Compliance or Touch Stop node are not able to generate a legal linear motion</p> <p>[Caution]In Compliance or Touch Stop Node, check if the teach points are at the same position or impossible to generate a legal linear motion</p> <p>[Precaution] This error would only show the "Calculation failed" on the pop up window, not in the HMI log.</p> <p>[Solution]Click on the OK and close the pop window</p> <p>Make sure the teach points are all suitable and correct.</p>
ErrorSuggestion00040024	<ol style="list-style-type: none"> 1. Please backup the HMI Log. 2. Please contact the original purchase of the manufacturer or a third party designated maintenance unit.
ErrorSuggestion00040025	Please check whether the SystimeFile.ini is correct.
ErrorSuggestion00040026	<ol style="list-style-type: none"> 1. Please backup the HMI Log. 2. Please contact the original purchase of the manufacturer or a third party designated maintenance unit.
ErrorSuggestion00040027	<p>[Cause]Project cannot run in Auto Mode when USB device plugged in the control box.</p> <p>[Caution]Check if there is no USB devices plugged on the control box</p> <p>[Additional Explanation] This error usually happens because the user forgets to remove the USB device from the control box before run the project in Auto Mode</p> <p>[Solution]To restore the robot from error status:</p> <ol style="list-style-type: none"> 1. Press the STOP button on the robot stick, or 2. Press the FREE button. 3. Remove the USB device from the control box

	Make sure all USB devices are removed from the control box before the project runs in Auto Mode.
ErrorSuggestion00040028	Please check whether the project is running.
ErrorSuggestion00040029	Please check whether the project is editing.
ErrorSuggestion0004002A	[Cause]The target project is not found while running function WARP [Caution]Please check if the target project selected in WARP function node is still exist [Solution]If the target project of the WARP function node has been deleted or renamed, please reset or erase the node Please remind when deleting or renaming a project if it is related to other project with WARP function
ErrorSuggestion0004002B	[Cause]Warp project failed [Caution]Check if the target project of the WARP node is damaged or deleted [Additional Explanation] This project are not likely to be damaged, possibly because of software issue [Solution] 1. Press the STOP button on the robot stick to restore from error status 2. Export both project files and log file 3. Contact a qualified service engineer for further analysis
ErrorSuggestion0004002C	Make sure the project used by WARP node exists [Cause]Unexpected software issue during project compiling [Caution]Check if there is any error messages followed [Additional Explanation] This error occurs if and only if there is an unexpected issue on software [Solution] 1. Press the STOP button on the robot stick to restore from error status 2. Export the project file and log file 3. Contact a qualified service engineer for further analysis
ErrorSuggestion0004002D	[Cause]System detected an error on Project Flow while the it is running [Caution]1. Check the message with this error code; it should specify which node has error 2. Check if there is another error code also occurs [Additional Explanation] There are lot of cases for this error, such as: 1. Any variables being used in the Project is deleted. 2. Incorrect settings on Pallet node, Circle node, etc. 3. Expressions or settings of If node, Waitfor node, Gateway node are incorrect 4. etc. [Solution]To restore the robot from Error Status : 1. Press the STOP button on the robot stick, or 2. Press the FREE button.

	<p>Follow the message of the error code and correct the error</p> <ol style="list-style-type: none"> 1. Be careful when deleting variables in Variable Manager. 2. Study and have a full understanding on Node Function, make sure the settings are correct
ErrorSuggestion0004002E	<p>[Cause]Fail to get control of the robot during the project running.</p> <p>[Caution]1. Check if the robot is controlled by other user</p> <ol style="list-style-type: none"> 2. Check if the robot is running a project 3. Check if the robot has been released control <p>[Additional Explanation] This error usually appears as a popped up message in HMI</p> <p>[Additional Explanation] This error usually happens when user wants to use the robot (Project Editing or Controller) while it is running a project.</p> <p>[Solution]To restore the robot from Error Status :</p> <ol style="list-style-type: none"> 1. Click on the OK button on the pop up windows. 2. Stop the running project through pressing the Stop button on Stick 3. Recover to get control of the robot by following steps in HMI : Log in --> Get control <ol style="list-style-type: none"> 1. Check if the robot is controlled by other user before using the robot. 2. Don't release control of the robot during project-running.
ErrorSuggestion00040030	<p>Please check whether Force-Torque sensor device is exist within SmartInsert Node</p>
ErrorSuggestion00040031	<p>[Cause]Robot detect the Force-Torque sensor occurred error during opening COM port.</p> <p>[Caution]Check if the COM port is correct in the Force-Torque sensor devices settings page.</p> <p>[Precaution] This error would only show on the pop up window, not in the HMI log.</p> <p>[Solution]Click on the OK and close the pop window</p> <p>Make sure the COM port setting is correct before use the Force-Torque sensor.</p>
ErrorSuggestion00040032	<p>Please check Modbus device setting are correct</p>
ErrorSuggestion00040033	<p>Please retry delete Modbus device</p>
ErrorSuggestion00040034	<p>Please check Force-Torque sensor is workable</p>
ErrorSuggestion00040035	<p>[Cause]Robot detect the Force-Torque sensor does not respond.</p> <p>[Caution]Check if the COM port cable is loose.</p> <p>[Additional Explanation] While the Force-Torque sensor is working, if the COM port cable is loose, it would cause this error.</p> <p>[Solution]Re-Plug the COM port cable on the robot.</p> <p>Make sure the COM port cable is stable during robot and Force-Torque sensor are working.</p>
ErrorSuggestion00040036	<p>[Cause]The issued Point node built by TMFlow Editor has not been complete yet</p> <p>[Caution]Check if the issued Point node is grey in color which means it is still in offline mode</p> <p>[Additional Explanation] Point node built by TMFlow Editor has no position information which need further set up on a robot</p> <p>[Solution]1. Click Stop on the robot stick to restore the error status</p>

	2. Complete the set up of the point node
	Make sure all motion related nodes built from TMFlow Editor has complete settings before project run or step run
ErrorSuggestion00040037	[Cause]System memory is not enough
	[Caution]
	[Solution]After restart the robot, if the problem still occurs, contact a qualified service engineer for further analysis.
ErrorSuggestion00040038	[Cause]The current node function created by offline editor has not been complete editing yet
	[Caution]1. Check if the error message following with this error and locate the issue node
	2. Check if the node is grey in color which means it is in offline mode
	[Additional Explanation] Motion related nodes are all in offline mode if they are created by offline editor, user need to complete the settings before usage
	[Additional Explanation] This error would be trigger during step run or project run
	[Solution]1. Press STOP button on the robot stick to restore the error status
	2. Finish the setting of the node on HMI
	Make sure all offline nodes are complete setting on HMI
ErrorSuggestion00040039	Please don't use vision keyword as a custom base prefix name
ErrorSuggestion0004003A	[Cause]The payload value set exceeds the maximum payload limit
	[Caution]Check if the payload value set exceeds the maximum payload limit
	[Precaution] This error would only show on the pop up window, not in the HMI log.
	[Solution]Click on the OK and close the pop window
	Check and make sure the payload value set on a node is within the maximum payload limit
ErrorSuggestion0004003B	[Cause]TCP loading (including Payload setting) is over limit
	[Caution]1. Check the mass of the TCP
	2. Check the Payload setting of the related motion node
	[Additional Explanation] This error usually shows as a pop up window
	[Additional Explanation] TCP load is defined as the mass of TCP used plus the Payload setting
	[Additional Explanation] Instead of motion related nodes, this will also happens on Controller if the Payload setting is over limit
	[Solution]1. Click OK to close the pop up window
	2. Modified the related settings
	Make sure the mass of TCP and Payload setting are within specification
ErrorSuggestion0004003C	NotActive
ErrorSuggestion0004003D	SendDataFail
ErrorSuggestion0004003E	ReceiveDataFail
ErrorSuggestion0004003F	InvalidReturnValue
ErrorSuggestion00040040	GetNoDataFromEmulator

ErrorSuggestion00040041	CheckOptimalSpeed
ErrorSuggestion00040042	Please move robot by free robot
ErrorSuggestion00040043	Please re-record robot point
ErrorSuggestion00040044	Please re-record robot point
ErrorSuggestion00040045	Please modify parameter of node
ErrorSuggestion00040046	Out of Cartesian limits set. Please check if the TCP or elbow is out of the Cartesian limits
ErrorSuggestion00040047	Robot TCP and/or elbow exceeds Cartesian limit
ErrorSuggestion00040048	Please enter another new project name
ErrorSuggestion00040100	Certification does not match Please download the latest certification file from website to start the installation process. The installation process will not proceed.
ErrorSuggestion00040101	Certification does not match Please request the certification file from the product provider, and put it under TMflow folder located under the installation directory to enable TMflow Editor. Program will be terminated automatically.
ErrorSuggestion00040102	[Warning][User Setting]Host and client versions conflict [Cause]The software version between the robot (host) and Tmflow.exe (client) is not matched [Caution]Check both versions of the robot (host) and the Tmflow.exe on PC (client) if they are matched or not [Precaution] If the versions are not matched, there would be possibly to trigger unexpected errors for certain functions [Solution]Click OK to close the pop up window Make sure both versions of the robot (host) and the Tmflow.exe on PC (client) are matched before login
ErrorSuggestion00040103	[Error][User Setting]Certification does not match. Please get the certification file from the product provider, and put it under TMflow folder located under the installation directory to enable TMflow Editor. Program will be closed automatically. [Cause]Certification for the corresponding HMI does not match [Caution]1. Check if the certification file on Techman folder is the correct version if this happens on Tmflow.exe 2. Check if the certification file on the USB drive exists or if it is the correct version for HMI update [Solution]1. Click OK to close the pop up window 2. Replace the file with the correct one Make sure the certification file is correct
ErrorSuggestion00040104	Please download the MD5 file to check the integrity of file.
ErrorSuggestion00040105	Please check or redownload the file.
ErrorSuggestion00040F80	ProxyServer initialize failure
ErrorSuggestion00040F81	ProxyServer initialize failure, TcpListener error
ErrorSuggestion00040F82	ProxyServer initialize failure, ServerParams error

ErrorSuggestion00040F83	ProxyServer initialize failure, ConfigData error
ErrorSuggestion00040F84	ProxyServer initialize failure, SystemFile error
ErrorSuggestion00040F85	ProxyServer initialize failure, OpenActioner error
ErrorSuggestion00040F86	ProxyServer initialize failure, OpenService error
ErrorSuggestion00041000	Communication error, please restart the robot.
ErrorSuggestion00041002	<p>[Cause]Emergency Stop has been triggered during resuming from a Cat.1 stop</p> <p>[Caution]1. Check if the Emergency Switch of the robot stick has been pressed</p> <p>2. Check if the Emergency port is being tripped</p> <p>[Additional explanation]</p> <p>1. Cat. 1 stop usually means Emergency Switch of the robot stick or the Emergency port on the Control Box being tripped</p> <p>2. During the resuming Cat. 1 (robot LED blinks red), the EtherCAT communication starts initializing and connecting all slaves, if any Emergency Switches are being tripped, power through the robot will cut off which makes the communication can no longer be available.</p> <p>[Solution]1. Makes sure any Emergency Related switches have been restored, then reboot the robot</p> <p>2. If the this issue still occurs, contact your service engineer for further analysis</p> <p>Prevent to trigger any Emergency Stop switch(es) during the resuming of Cat.1 stop</p>
ErrorSuggestion00041003	<p>[Cause]Inverse Kinematics failure</p> <p>[Caution]Check if there is any custom base in the current project which may be badly assigned</p> <p>[Additional Explanation] If the inverse kinematics of the target point is failed to be solved, it may trigger this error</p> <p>[Additional Explanation] This may possibly because the custom base used is badly assigned, e.g., 3 points on the same line</p> <p>[Solution]1. To restore the robot from error status:</p> <p>Press the STOP button on the robot stick, or press the FREE button</p> <p>2. Export the project file and log file to a qualified service engineer for further analysis</p> <p>Make sure the custom base is well assigned</p>
ErrorSuggestion00041004	<p>1. Please backup the HMI Log.</p> <p>2. Please contact the original purchase of the manufacturer or a third party designated maintenance unit.</p>
ErrorSuggestion00041005	Communication error, please restart the robot.
ErrorSuggestion00041008	<p>[Cause]The joint is rotating over its degree setting range or the robot's position exceeds the defined working area.</p> <p>[Caution]1. Check to see if the Joint Position on Settings\Safety Settings\Safety Stop Criteria\Joint Position is set with the correct limits</p> <p>2. Check to see if the Working Area on Settings\Operation Space\Stop Plane is set correctly</p> <p>[Precaution] It's would also show which joint is exceeds the limit to notice the user to check the Joint Position</p>

setting.

[Solution]To restore the robot from Error Status :

1. Press the STOP button on the robot stick, or
2. Press the FREE button.

1. Make sure the Joint Position on Settings\Safety Settings\Safety Stop Criteria\Joint Position is set with the correct limits

2. Make sure the Working Area on Settings\Operation Space\Stop Plane is set correctly

ErrorSuggestion00041009 Rtx start failure

ErrorSuggestion0004100A Rtx lincense failure

ErrorSuggestion00042000 Please check whether the project file is present or damaged.

ErrorSuggestion00042001 1. Please backup the HMI Log.

2. Please contact the original purchase of the manufacturer or a third party designated maintenance unit.

ErrorSuggestion00042002 1. Please backup the HMI Log.

2. Please contact the original purchase of the manufacturer or a third party designated maintenance unit.

ErrorSuggestion00042003 1. Please backup the HMI Log.

2. Please contact the original purchase of the manufacturer or a third party designated maintenance unit.

ErrorSuggestion00042004 1. Please backup the HMI Log.

2. Please contact the original purchase of the manufacturer or a third party designated maintenance unit.

ErrorSuggestion00042005 1. Please backup the HMI Log.

2. Please contact the original purchase of the manufacturer or a third party designated maintenance unit.

ErrorSuggestion00042006 Please check whether the space on the disk is insufficient.

ErrorSuggestion00042007 1. Please backup the HMI Log.

2. Please contact the original purchase of the manufacturer or a third party designated maintenance unit.

ErrorSuggestion00042008 Please check whether the type of variable set in the project is correct.

ErrorSuggestion00042009 1. Please backup the HMI Log.

2. Please contact the original purchase of the manufacturer or a third party designated maintenance unit.

ErrorSuggestion0004200A 1. Please backup the HMI Log.

2. Please contact the original purchase of the manufacturer or a third party designated maintenance unit.

ErrorSuggestion0004200B Please check whether the variable settings in the project are correct.

ErrorSuggestion00043000 1. Please backup the HMI Log.

2. Please contact the original purchase of the manufacturer or a third party designated maintenance unit.

ErrorSuggestion00043001 Please check whether the SystemFile.ini is correct.

ErrorSuggestion00043002 1. Please backup the HMI Log.

2. Please contact the original purchase of the manufacturer or a third party designated maintenance unit.

ErrorSuggestion00043003 [Cause]HMI detected that the vision job file is damaged

[Caution]Check if the vision job can still be edited through HMI

	[Additional Explanation] This error is not likely to happen
	[Additional Explanation] The vision job file might be damaged if there is an software issue
	[Solution]1. Click Stop on the robot stick to restore the error status 2. Export the project file and log file 3. Contact with a qualified service engineer for further analysis
ErrorSuggestion00043004	[Cause]vision job file is damaged or deleted [Caution]Check if the vision job can still be edited through HMI [Additional Explanation] This error is not likely to happen [Additional Explanation] The vision job file might be damaged or deleted if there is an software issue [Solution]1. Click Stop on the robot stick to restore the error status 2. Export the project file and log file 3. Contact with a qualified service engineer for further analysis
ErrorSuggestion00043005	1. Please backup the HMI Log. 2. Please contact the original purchase of the manufacturer or a third party designated maintenance unit.
ErrorSuggestion00043006	[Cause]The camera's usb cable connection is loosen during project running. [Caution] [Additional Explanations] This error is not likely to happen if the robot is not being dismantling illegally [Solution]1. Export the Logs 2. Contact a qualified service engineer for further analysis Make sure only the qualified engineer could do any repairing on the hardware
ErrorSuggestion00043007	1. Please backup the HMI Log. 2. Please contact the original purchase of the manufacturer or a third party designated maintenance unit.
ErrorSuggestion00043008	1. Please backup the HMI Log. 2. Please contact the original purchase of the manufacturer or a third party designated maintenance unit.
ErrorSuggestion00043009	Vision job failed, please check vision job setting.
ErrorSuggestion0004300A	1. Please backup the HMI Log. 2. Please contact the original purchase of the manufacturer or a third party designated maintenance unit.
ErrorSuggestion0004300B	[Cause]Calculation of coordinate or arm posture correction occurs error. [Caution]Check the other error code come along with it. [Additional Explanation] This error does not likely happen, low possibility. [Solution]1. Click Stop on the robot stick to restore the error status 2. Run the project again 3. If this error still happens, contact a qualified service engineer for further analysis
ErrorSuggestion0004300C	1. Please backup the HMI Log. 2. Please contact the original purchase of the manufacturer or a third party designated maintenance unit.
ErrorSuggestion0004300D	1. Please backup the HMI Log.

	2. Please contact the original purchase of the manufacturer or a third party designated maintenance unit.
ErrorSuggestion0004300E	1. Please backup the HMI Log. 2. Please contact the original purchase of the manufacturer or a third party designated maintenance unit.
ErrorSuggestion00044000	[Cause]Modbus-TCP failed to initialize during power-on [Caution]1. Check if the Ethernet cable is loosen 2. Check if the Ethernet Connection is not on the general usage LAN port (not those 2 for GigE Camera) [Additional Explanation] Modbus can only be initialized if the general usage LAN port (not those 2 for GigE Camera) is activated during power-on [Solution]1. Connect the general usage LAN with Ethernet 2. Disable and then Enable Modbus at Setting/Modbus Make sure the general usage LAN port (not those 2 for GigE Camera) has been connected to Ethernet before power-on
ErrorSuggestion00044001	Read failed. Please check whether the data is correct.(Head)
ErrorSuggestion00044002	Please contact the original purchase of the manufacturer or a third party designated maintenance unit.
ErrorSuggestion00044003	[Cause]Program exception during Modbus writing [Caution]1. Export the log and project file 2. Contact a qualified service engineer [Additional Explanation] This error is not likely happens, only if there is a software issue [Solution]
ErrorSuggestion00044004	Read address failed. Please check whether the data is correct.
ErrorSuggestion00044005	[Cause]Modbus-RTU failed to initialize during power-on [Caution]1. Check if the Serial Port cable is loosen 2. Check if any Rs232 related device is loosen [Additional Explanation] This usually happens if USB - Rs232 convertor is used that an extra COM port is used for Modbus-RTU. If the cable or converter is unplugged, the extra COM-port would be disable and trigger this error [Solution]1. Connect all related rs232 cable or convertor onto the Control Box 2. Disable and then Enable Modbus at Setting/Modbus 1. It is suggested not to use USB-Rs232 convertor for Modbus-RTU 2. Make sure cable or convertor used is plug well before power on
ErrorSuggestion00044200	None.
ErrorSuggestion00044201	None.
ErrorSuggestion00044202	1. Please backup the HMI Log. 2. Please contact the original purchase of the manufacturer or a third party designated maintenance unit.
ErrorSuggestion00044203	1. Please backup the HMI Log. 2. Please contact the original purchase of the manufacturer or a third party designated maintenance unit.
ErrorSuggestion00044204	1. Please backup the HMI Log.

ErrorSuggestion00044205	<p>2. Please contact the original purchase of the manufacturer or a third party designated maintenance unit.</p> <p>[Cause] CIFX Communication Card Software Program Error</p> <p>[Warning] 1. Please check if CIFX communication card is installed or loose</p> <p>[Solution] 1. Turn off the function and re-enable it.</p> <p>2. Please contact the original purchaser or a third-party designated maintenance organization to confirm whether the driver software for the CIFX communication card is installed.</p> <p>3. Please contact the original purchase manufacturer or a third-party designated maintenance unit to confirm that the firmware and configuration files of the CIFX communication card are installed correctly.</p> <p>4. If this error still occurs, please backup the HMI Log and contact the engineer for further analysis.</p>
ErrorSuggestion00044206	<p>[Cause] An error occurred in the driver of the CIFX communication card</p> <p>[Warning] 1. Please check if CIFX communication card is installed or loose</p> <p>[Solution] 1. Turn off the function and re-enable it.</p> <p>2. Please contact the original purchaser or a third-party designated maintenance organization to confirm whether the driver software for the CIFX communication card is installed.</p> <p>3. Please contact the original purchase manufacturer or a third-party designated maintenance unit to confirm that the firmware and configuration files of the CIFX communication card are installed correctly.</p> <p>4. If this error still occurs, please backup the HMI Log and contact the engineer for further analysis.</p>
ErrorSuggestion00044207	<p>[Cause] CIFX communication failed</p> <p>[Warning] 1. Please check if the network port used is the network port on the CIFX communication card.</p> <p>2. Please check if the network cable is loose.</p> <p>3. Please check whether the physical wiring of the actual application field is correct.</p> <p>4. Please check whether the settings of the communication card (for example: IP, device ID, device name) are correct.</p> <p>5. Please check whether the software settings and files of the controller (eg PLC) are correct.</p> <p>[Solution] 1. Turn off the function and re-enable it.</p> <p>2. Please contact the original purchaser or a third-party designated maintenance unit to confirm that the firmware and configuration files of the CIFX communication card are installed correctly.</p> <p>3. If this error still occurs, please backup the HMI Log and contact the engineer for further analysis.</p>
ErrorSuggestion00044208	<p>1. Please backup the HMI Log.</p> <p>2. Please contact the original purchase of the manufacturer or a third party designated maintenance unit.</p>
ErrorSuggestion00044209	Please setup CIFX communication card.
ErrorSuggestion0004420A	Please setup the driver of CIFX communication card.
ErrorSuggestion0004420B	Please setup CIFX communication card and driver.
ErrorSuggestion0004420C	Please setup firmware and config file.
ErrorSuggestion00044280	<p>[Cause] The system could not read the data through the Profinet function</p> <p>[Warning] 1. Please check if CIFX communication card supports Profinet communication protocol.</p>

	<p>2. Please check if Profinet communication function is enabled.</p> <p>3. Please check if the function name and parameters are correct.</p> <p>[Solution] 1. Enter the correct function name and parameters, and run the project again.</p> <p>2. Please contact the original purchaser or a third-party designated maintenance unit to confirm that the firmware and configuration files of the CIFS communication card are installed correctly.</p> <p>3. If this error still occurs, please backup the HMI Log and contact the engineer for further analysis.</p>
ErrorSuggestion00044281	<p>[Cause] The system could not read the data through the Profinet function</p> <p>[Warning] 1. Please check if CIFS communication card supports Profinet communication protocol.</p> <p>2. Please check if Profinet communication function is enabled.</p> <p>3. Please check if the function name and parameters are correct.</p> <p>[Solution] 1. Enter the correct function name and parameters, and run the project again.</p> <p>2. Please contact the original purchaser or a third-party designated maintenance unit to confirm that the firmware and configuration files of the CIFS communication card are installed correctly.</p> <p>3. If this error still occurs, please backup the HMI Log and contact the engineer for further analysis.</p>
ErrorSuggestion00045000	<p>[Cause]The system detected a disconnection on the USB drive during the process of Import/Export</p> <p>[Caution]1. Check if the USB drive is plugged well onto the control box.</p> <p>2. If the USB drive is plugged well, try another USB drive and see if the same issue happens during Export/Import.</p> <p>3. Check if there are other USB devices on the control box, remove them and try again</p> <p>[Additional Explanation] If the USB drive is confirmed to be plugged well, that means this error maybe caused by USB or USB port hardware/firmware issue</p> <p>[Solution]1. To restore the robot from Error Status : Press the STOP button on the robot stick, or press the FREE button.</p> <p>2. Make sure the USB drive is well connected to the control box</p> <p>3. Try Import/Export again</p> <p>1. Avoid removing the USB drive during the process of Import/Export</p> <p>2. After finishing the process of export/ import job, wait for a few seconds before unplugging the USB drive</p>
ErrorSuggestion00045001	<p>[Cause]External drive do not have enough free space for user export data.</p> <p>[Caution]Check if the disk space is insufficient.</p> <p>[Additional Explanations] If user wants to export a very large data from robot, the external devices needs a sufficient free space.</p> <p>[Solution]To restore the robot from Error Status :</p> <p>Find another usb which has enough space for data export.</p> <p>Check the external devices which has enough space for data export.</p>
ErrorSuggestion00045002	<p>Files are held. Please try again after restart</p>
ErrorSuggestion00045003	<p>[Cause]The compressed file in the USB drive had been damaged and the system failed to import it</p> <p>[Caution]1. Check if the compressed file in the USB drive is damaged by trying to unzip; if it is damaged, there</p>

would be a related message.

2. Check if that file fails to be imported to this robot only.

3. Check if other files in the USB drive also have the same issue.

[Additional Explanation]

1. Removing the USB drive too quickly just after exporting a file (even with the message of "Export successfully")

might damage it

[Solution]1. To restore the robot from Error Status :

Press the STOP button on the robot stick, or

Press the FREE button.

1. After exporting the file, keep the USB drive still for a few seconds before unplugging it from the control box

ErrorSuggestion00045004 [Cause]Robot detect the file can not be accessed or executed.

[Caution]

[Additional Explanation] When the robot can not access the data from project 、 system update 、 backup/recovery、 Path node file ...etc, it would cause this error.

[Solution]1. Click on the OK button on the pop windows.

2. Press STOP button on the robot stick.

3. Contact your service engineer and export the Logs for further analysis.

ErrorSuggestion00045005 [Cause]Robot detect the file can not be accessed or executed.

[Caution]

[Precaution] This error would only show on the pop up window, not in the HMI log.

[Solution]1. Click on the OK and close the pop window.

2. Contact your service engineer and export the Logs for further analysis.

ErrorSuggestion00045006 [Cause]TM client fails to connect to the robot(server)

[Caution]Check if the network connection/cable between robot and client is stable.

[Additional Explanation] Abnormal socket disconnection would cause program error exception while the program is running between robot and client.

[Solution]Press STOP button on the robot stick

Make sure the network connection/cable is stable during the connection process.

ErrorSuggestion00045007 [Cause]The connection between robot and the TM clients is failed.

[Caution]Check if the network connection/cable between robot and client is stable.

[Additional Explanation] Abnormal socket disconnection would cause program error exception while the program is running between robot and client.

[Solution]Press STOP button on the robot stick

Make sure the network connection/cable is stable during the connection process.

ErrorSuggestion00045008 [Cause]The communication between robot and the TM client is failed.

	<p>[Caution]Check if the network connection/cable between robot and client is stable.</p> <p>[Additional Explanation] Abnormal socket disconnection would cause program error exception while the program is running between robot and client.</p> <p>[Solution]Press STOP button on the robot stick</p> <p>Make sure the network connection/cable is stable during the connection process.</p>
ErrorSuggestion00045009	<p>1. Please backup the HMI Log.</p> <p>2. Please contact the original purchase of the manufacturer or a third party designated maintenance unit.</p>
ErrorSuggestion0004500A	<p>[Cause]HMI client and HMI server is disconnection.</p> <p>[Caution]Check if there is any follow up error logs or messages with this error code.</p> <p>[Solution]1. Press STOP button on the robot stick.</p> <p>2. Contact your service engineer and export the Logs for further analysis.</p>
ErrorSuggestion0004500B	<p>[Cause]Robot detect the network path settings is wrong or can not be accessed.</p> <p>[Caution]1.Check if the network path in the export/import is correct.</p> <p>2.Check if the network cable is loose.</p> <p>[Additional Explanation] Abnormal network disconnection would cause data transfer failed.</p> <p>[Solution]1. Click on the OK button and close the pop window.</p> <p>2. Press STOP button on the robot stick.</p> <p>Make sure the network setting/cable are correct and stable before/during the data transfer process.</p>
ErrorSuggestion0004500C	<p>[Cause]The space of system drive is not enough.</p> <p>[Caution]Check if have the enough space of the system drive (for TMFlow.exe on PC)</p> <p>[Additional Explanation] This error usually appears in HMI during Import/Export files if there is not enough space in the system</p> <p>[Solution]To restore the robot from Error Status :</p> <p>(Import/Export)</p> <p>1. Click on the OK button on the pop up windows.</p> <p>2. Stop the running project through pressing the Stop button on Stick</p> <p>3. Clear some data and reserve enough free space for use.</p> <p>Make sure there is enough space for storage on the system</p>
ErrorSuggestion0004500D	<p>Please check whether the UNC path is correct include username and password</p>
ErrorSuggestion00045100	<p>[Cause]HMI update failed</p> <p>[Caution]1. Shutdown and power on the system again to see if this error still appears</p> <p>[Additional Explanation] If the update is interrupted during process, such as, closing the execution windows, restart or power off the system manually, power cut-off, etc.; this might cause the control box and robot's firmware update incomplete and failed.</p>

[Solution]Contact a qualified service engineer for further analysis

Avoid any interruption during HMI update:

1. Do not cut off the power during process
2. Do not close the execution windows during process
3. Do not close or restart the system manually during process

ErrorSuggestion00045101 Please contact the original purchase of the manufacturer or a third party designated maintenance unit.

ErrorSuggestion00048000 [Cause]HMI detected an array assignment error.

[Caution]Check if any array has been assigned with the different data type variables

[Additional Explanation] This error usually appears as a popped up message in HMI

[Additional Explanation] This error usually happens because the user assign ("=") the mismatching data type to array in the flow.

i.e. int[]/ var_arrayA = bool[]/var_arrayB

i.e. int[]/ var_arrayA = bool/var_b

i.e. bool[]/ var_arrayB = int[]/ var_arrayA

i.e. bool[]/ var_arrayB = int/var_i

[Solution]To restore the robot from Error Status :

1. Click on the OK button on the pop up windows.

Make sure all arrays are assigned correctly by data type, such as

(1) int[]/ var_arrayA = int[]/var_arrayB

==> (arrayA == arrayB)

(2) int[]/ var_arrayA = int[]/var_arrayB[0]

==> (arrayA == arrayB[0])

ErrorSuggestion00048001 [Cause]Value assigned is in invalid number format

[Caution]Check if the value assigned to a variable is valid format type.

[Additional Explanation] For number format,

Incorrect:

0x12CG // Hex includes values(0-9, A-F). 「G」 is invalid.

0b1212 // Binary includes values(0, 1). 「2」 is invalid.

Correct:

0x12CF // Hex value is valid.

0b1110 // Binary value is valid.

[Additional Explanation]

This error usually appears in

1. The project file is generated by 3rd party flow editor
2. The input format error in Listen Node

3. In flow editing, it usually appears with a pop-up windows with warning message 「Invalid Value」

[Solution]To restore the robot from error status:

1. Press the STOP button on the robot stick, or
2. Press the FREE button
3. Input the valid number format

if it appears the pop-up windows with warning message 「Invalid Value」 , click OK to close it

Make sure the variables used are with a valid number format.

ErrorSuggestion00048002

[Cause]There are repeated cases in the conditional expression in project.

[Caution]Check if this error is triggered in the following items

1. SET Node
2. Listen Node

[Additional Explanation]

This error usually appears if

1. The project file is generated by 3rd party flow editor
2. The input format to Listen Node is incorrect

[Solution]1. Click Stop on the robot stick to restore the error status

2. Remove the repeated cases in the conditional expression

Make sure there is no repeated cases in the conditional expressions in the project.

ErrorSuggestion00048003

[Cause]There are variables created with the repeated name in project.

[Caution]Check if there are variables with the same name.

[Additional Explanation]

This error usually appears if

1. The project file is generated by 3rd party flow editor
2. The input format to Listen Node is incorrect

3. In flow editing, it usually appears with a pop-up windows with warning message 「Variable Name Repeat」

[Solution]1. Press the STOP button on the robot stick, or

2. if this error appears as a pop-up windows with the error message 「Variable Name Repeat」 , click OK to close it
3. Remove the variable with repeated name

Make sure there is no repeated variables in the project.

ErrorSuggestion00048004

[Cause]An invalid expression is found within the current Project

[Caution]1. Check the description with this error, which shows the error node and the expression with it

2. Check if that expression is invalid or not

[Additional Explanation] This error would be shown on either pop out window on HMI or Notice Log

[Solution]To restore the robot from Error Status :

1. Click on the OK button on the pop up windows.
2. Correct the expression

	<ol style="list-style-type: none"> 1. Have fully understanding on expression functions before programming 2. Make sure all expressions are correct 3. Make sure the variables used in expressions would not set to invalid value during project run
ErrorSuggestion00048005	Please check variable manager, this variable is undefined.
ErrorSuggestion00048006	<p>[Cause]Undefined functions in the expression editor</p> <p>[Caution]1. Follow the description on the log and check to see if the variable names and function syntax are correct 2. Check to see if any variables used in the expression editor have been deleted from the Variable Manager</p> <p>[Additional Explanation] This error usually appears as a popped up message in HMI</p> <p>[Solution]Confirm that the variables used in the expression editor exist and that the proper function syntax has been followed</p> <ol style="list-style-type: none"> 1. Make sure to use proper variable names and syntax within the expression editor according to the current HMI version 2. Avoid deleting variables that are still in use
ErrorSuggestion00048007	<p>[Cause]Invalid expression</p> <p>[Caution]In SET node, It is invalid in the expression with the form: <code>int\var_j= GetNow()+=10</code></p> <p>(Functions with the following operands : 「 += 」 、 「 -= 」 、 「 *= 」 、 「 /= 」)</p> <p>[Additional Explanation] This error usually appears in</p> <ol style="list-style-type: none"> 1. The project file is generated by 3rd party flow editor 2. In flow editing, it usually appears with a pop-up windows with warning message 「Function operation is not allowed」 <p>[Solution]1. Press the STOP button on the robot stick, or 2. if this error appears as pop-up windows with the error message 「Function operation is not allowed」 , click OK to close it 3. Remove the invalid operand (「 += 」 、 「 -= 」 、 「 *= 」 、 「 /= 」) triggering the error Make sure all expressions all correct</p>
ErrorSuggestion00048008	<p>[Cause]The expression is assigned with an invalid operator in array operations.</p> <p>[Caution]Check if there is any missing index of the array. Or an incorrect operator has been chosen</p> <p>[Precaution] This error would only show on the pop up windows, not in the HMI log.</p> <p>[Additional Explanations] The error code is often triggered between two arrays' operation without index assigning: In assignment expression of project node (SET).</p>

Incorrect operators: (" += ", " -= ", " *= ", " /= ")

(i.e. var_array_A += var_array_B)

Correct operators: (" = ")

(i.e. var_array_A = var_array_B)

In comparison expression of project node (IF).

Incorrect operators: (" > ", " >= ", " < ", " <= ")

(i.e. var_array_A >= var_array_B)

Correct operators: ("==" or "!=")

(i.e. var_array_A == var_array_B)

[Solution]To restore the robot from Error Status :

Click on the OK button on the pop up windows then assign the suitable operators.

Makes sure all assignment and comparison expressions have the valid operator.

ErrorSuggestion00048009

[Cause]The index used on a array variable is not a integer

[Caution]Check if any variables used as an array index in the project is assigned to be a null value or a non-integral value

[Additional explanation] The variable used as an array index is invalid in value possibly by initialization or assigned by SET node during project run

[Additional Explanation] If the variable used as an array index is deleted, the value will become null

[Solution]1. Press STOP button on the robot stick, or press free robot button.

2. Then you can find the robot LED shows green color

Make sure before you delete any variable in the project, check if it is as an array index or not

ErrorSuggestion0004800A

[Cause]The expression is assigned with an invalid operand.

[Caution]Check if the operands of the related expression (which operators are: "==", ">=", "<==", etc.) are assigned the number type value or variable in the current project node (SET, IF, etc.)

[Precaution] This error would only show on the pop up windows, not in the HMI log.

[Solution]To restore the robot from Error Status :

Click on the OK button on the pop up windows then assign the number type value or variable to the operands.

Makes sure all expressions have the valid operand.

ErrorSuggestion0004800B

[Cause]The expression is assigned with an invalid operand.

[Caution]Check if the value or variable is integer type after the complement operator (" ~ ") in the current project node (SET, IF, etc.)

[Precaution] This error would only show on the pop up windows, not in the HMI log.

[Solution]To restore the robot from Error Status :

Click on the OK button on the pop up windows then assign the integer type value or variable to the operand after the complement operator.

Makes sure all expressions with the complement operator have the valid operand.

ErrorSuggestion0004800C	<p>[Cause]System detected an error on Project Flow while the it is running, which is mostly because some variables are missing.</p> <p>[Caution]1. Check the message with this error code; it should specify which node has error 2. Check if there is another error code also occurs</p> <p>[Additional Explanation] Remind of the following cases:</p> <ol style="list-style-type: none"> 1. Variables created by Pallet node have been deleted manually. 2. Variables used in any expression (If, Waitfor, Gateway, etc.) have been deleted manually. 3. Global variables used in the current robot will not be exported with the project; user need to create the same Global variable or export them separately 4. etc. <p>[Solution]To restore the robot from Error Status :</p> <ol style="list-style-type: none"> 1. Press the STOP button on the robot stick, or 2. Press the FREE button. <p>Follow the message of the error code and correct the error</p> <ol style="list-style-type: none"> 1. Be careful when deleting variables in Variable Manager. 2. Study and have a full understanding on Node Function, make sure the settings are correct
ErrorSuggestion0004800D	<p>[Cause]In the expression, the data type of variable assignment error.</p> <p>[Caution]Check if the operand 「++」 or 「--」 are used properly with integer data type</p> <p>[Additional Explanation]</p> <p>This error usually happens in a SET Node.</p> <p>The operands 「++」 、 「--」 are only used by integer variable. (i.e. var A: A++, A--, ++A, --A)</p> <p>[Solution]1. Click OK and close the popped up windows 2. Correct the data type of variable as integer type in expression</p> <p>Make sure the operand 「++」 or 「--」 are used properly with integer data type</p>
ErrorSuggestion0004800E	<p>[Cause]the item following the symbol "!" is invalid in an expression which is supposed to be a Boolean type object (or variable)</p> <p>[Caution]Check if the subject after the symbol "!" is a Boolean type object or not</p> <p>[Precaution] This error would only show on the pop up windows, not in the HMI log.</p> <p>[Solution]To restore the robot from Error Status :</p> <ol style="list-style-type: none"> 1. Click on the OK button on the pop up windows. 2. Correct the expression <p>Check and confirm the type is correct while creating an expression.</p>
ErrorSuggestion0004800F	<p>[Cause]The expression is assigned with an invalid operand.</p> <p>[Caution]Check if the operand in the left side of the assignment operator (" = ") is type matching with the right side</p>

	<p>one in the current project node (SET)</p> <p>[Precaution] This error would only show on the pop up windows, not in the HMI log.</p> <p>[Solution]To restore the robot from Error Status :</p> <p>Click on the OK button on the pop up windows then assign the same type value or variable to the operand in the expression.</p> <p>Makes sure all assignment of expressions have the valid type-matching operand.</p>
ErrorSuggestion00048010	<p>[Cause]There is an invalid usage on an expression</p> <p>[Caution]Check if the data type is matched from both sides of an expression, especially on an IF node</p> <p>[Precaution] This error would only show on the pop up windows, not in the HMI log.</p> <p>[Additional Explanation] This error would be triggered if there is an invalid symbol usage and only have it on an expression, for example:</p> <p>string == ###</p> <p>[Solution]To restore the robot from Error Status :</p> <ol style="list-style-type: none"> 1. Click on the OK button on the pop up windows. 2. Correct the expression <p>Check and confirm the type is correct while creating an expression.</p>
ErrorSuggestion00048011	<p>[Cause]The operand in the expression is assigned a number out of range .</p> <p>[Caution]Check if an integer type operand is assigned a number large than 2147483647 in the current project node (SET).</p> <p>[Precaution] This error would possibly show on the pop up windows.</p> <p>[Solution]To restore the robot from Error Status :</p> <p>Click on the OK button on the pop up windows then assign an integer number less than 2147483648 to the operand.</p> <p>Makes sure all assignment of expressions have the valid operand with the appropriate value.</p>
ErrorSuggestion00048012	<p>[Cause]The expression has missing the right parentheses.</p> <p>[Caution]Check the expression in the current project node (SET, IF, WAITFOR, etc.) whether the expression misses any parentheses.</p> <p>[Precaution] This error would only show on the pop up windows, not in the HMI log.</p> <p>[Solution]To restore the robot from Error Status :</p> <p>Click on the OK button on the pop up windows then make up a right parentheses.</p> <p>Makes sure all expressions has the right parentheses.</p>
ErrorSuggestion00048013	<p>[Cause]The expression has missing the right Bracket when access the array data with index.</p> <p>[Caution]Check the expression in the current project node (SET, IF, WAITFOR, etc.) whether the expression misses any bracket on the right side.</p> <p>[Precaution] This error would only show on the pop up windows, not in the HMI log.</p>

	<p>[Solution]To restore the robot from Error Status :</p> <p>Click on the OK button on the pop up windows then make up a right Brackets.</p> <p>Makes sure all expressions has right Brackets.</p>
ErrorSuggestion00048014	<p>[Cause]The expression has missing the right Brace.</p> <p>[Caution]Check the expression in the current project node (SET, IF, WAITFOR, etc.) whether the expression misses any Brace.</p> <p>[Precaution] This error would only show on the pop up windows, not in the HMI log.</p>
ErrorSuggestion00048015	<p>[Solution]To restore the robot from Error Status :</p> <p>Click on the OK button on the pop up windows then make up a right Brace.</p> <p>Makes sure all expressions has the right Brace.</p>
ErrorSuggestion00048016	<p>[Cause]PLAY being triggered just after stopping a project</p> <p>[Caution]1. Check if the PLAY button has been triggered just after stopping a project 2. Check if there is any external device trigger PLAY with I/O or Modbus</p> <p>[Additional Explanation] This error does not likely happen, low possibility</p> <p>[Additional Explanation] PLAY can be triggered by either robot stick, configurable IO or Modbus</p> <p>[Solution]1. Click Stop on the robot stick to restore the error status 2. Run the project again 3. If this error still happens, contact a qualified service engineer for further analysis</p> <p>Make sure not to trigger PLAY just after stopping a project, have a buffer of few seconds</p>
ErrorSuggestion00048016	<p>[Cause]The HMI detected a division calculation error during the project running</p> <p>[Caution]1. Check if any variables as a divisor in the project is assigned a value zero by initial setting or during process</p> <p>[Additional Explanation] It often occurs in the division expression of SET and Display Node, or in the Boolean expression of IF and Gateway Node in the project flow</p> <p>[Solution]To restore the robot from Error Status :</p> <p>Press the STOP button on the robot stick, or press the FREE button.</p> <p>1. Designing a program mechanism examines that every variable as a divisor and prevent it running if it is assigned zero</p>
ErrorSuggestion00048017	<p>[Cause]Project Flow contains expression modulo by zero</p> <p>[Caution]1. Check if any variable used as the divisor of a modulo expression could possibly change to zero during project run</p> <p>[Additional Explanation]</p> <p>Usually, HMI will block the expression (warning message) if it is directly as, e.g., "var_result = var_num1%0"; however, if the expression is written as, e.g., "var_result = var_num1%var_num2", if var_num changes to 0 during project run will trigger this error.</p> <p>[Solution]1. To restore the robot from Error Status :</p>

ErrorSuggestion00048018	<p>Press the STOP button on the robot stick, or press the FREE button.</p> <p>2. Correct the issued expression(s)</p> <p>Make sure the variables used as the divisor will never be zero, either by initialization or</p> <p>[Cause]The HMI detected an invalid index used on a array variable during project run</p> <p>[Caution]Check if the value any variables used as an array index is out of range or a negative quantity</p> <p>[Additional explanation] The variable used as an array index is invalid in value possibly by initialization or assigned by SET node during project run</p> <p>[Solution]To restore the robot from Error Status :</p> <ol style="list-style-type: none"> 1. Press the STOP button on the robot stick, or 2. Press the FREE button. <ol style="list-style-type: none"> 1. Make the initial value of all index variables is correct 2. Make sure the value of all index variables would not be change incorrectly by any SET node
ErrorSuggestion00048019	<ol style="list-style-type: none"> 1. Please backup the HMI Log and Projects. 2. Please contact the original purchase of the manufacturer or a third party designated maintenance unit.
ErrorSuggestion0004801A	<ol style="list-style-type: none"> 1. Please backup the HMI Log and Projects. 2. Please contact the original purchase of the manufacturer or a third party designated maintenance unit.
ErrorSuggestion0004801B	<p>[Cause]The operand in the assignment expression is assigned with a different type number.</p> <p>[Caution]Check if the operand on the left side of the assignment operator (" = ") is type matching with the right side one in the current project node (SET)</p> <p>[Precaution] An error message 『Warning for Number Value maybe missing』 would show on the pop up windows when project is edited.</p> <p>If ignore it, this error code would show with the warning message in the HMI log during project running.</p> <p>[Additional Explanation]</p> <p>Number related expression should have the following instruction when using different types, i.e. :</p> <p>Correct :</p> <ol style="list-style-type: none"> 1. double = int 2. float = int 3. double = float <p>Incorrect :</p> <ol style="list-style-type: none"> 1. int = double 2. int = float 3. float = double <p>[Solution]To restore the robot from Error Status :</p> <ol style="list-style-type: none"> 1. Press the STOP button on the robot stick, or 2. Press the FREE button. 3. Then assign the same type number value or variable to the operands in the expression.

	Makes sure all assignment expressions have the valid type-matching number operands.
ErrorSuggestion0004801C	<p>[Cause]System cannot detect the sensor through serial port</p> <p>[Caution]Check if the USB-Serial converter cable is loosen</p> <p>[Additional Explanation] This error only happens on force control related node (smart insert, polish, etc) using force torque with rs232 interface</p> <p>[Additional Explanation] COM Port generated by USB-Serial convertor would be deleted if the cable is loosen</p> <p>[Precaution] The Serial Port number might change if the convertor is plugged onto a different usb port</p> <p>[Solution]1. Press Stop Button on the robot stick to restore the error status</p> <p>2. Reconnect the convertor back to the SAME usb port</p> <p>1. It is not suggested to use USB-Serial convertor</p> <p>2. If it is necessary, please make sure the convertor is always plugged well</p>
ErrorSuggestion0004801D	<p>[Cause]System failed to open a Modbus master</p> <p>[Caution]1. Check if the robot is connected to the network, including wire connection, and the quality of the network</p> <p>2. Check if the Setting\Network Setting is correct or not (if using Modbus TCP)</p> <p>3. Check if the settings on Modbus TCP Device is correct or not , including: ip address, port, address, signal type, etc.</p> <p>4. Check if the settings on Modbus RTU Device is correct or not , including: ComPort, BaulRate, DataBits, StopBits, ParityCheck, address, signal type, etc.</p> <p>[Additional Explanation] For Modbus TCP, this usually happens because the robot is not connected to the network or network settings (especially, IP Address and Port)</p> <p>[Additional Explanation] For Modbus RTU, this usually happens because the ComPort selected has already been used by other functions (normal usage on Serial Port)</p> <p>[Solution]1. Confirm and restore the network, then enable Modbus again on Settings\Modbus</p> <p>2. Confirm and correct the settings of Modbus Devices, then enable Modbus again on Settings\Modbus</p> <p>1. Regularly check the quality of the network, including hardware.</p> <p>2. It is suggested to have knowledge on Modbus before usage</p>
ErrorSuggestion0004801E	Please check whether COM port settings of Serial Port are correct.
ErrorSuggestion0004801F	<p>[Cause]Unexpected software issue</p> <p>[Caution]Check if there is any error messages followed</p> <p>[Additional Explanation] This error occurs if and only if there is an unexpected issue on software</p> <p>[Solution]1. Export the project file and log file</p> <p>2. Contact with a qualified service engineer for further analysis</p>
ErrorSuggestion00048020	<p>[Cause]System failed to read data through Modbus</p> <p>[Caution]1. Check if the robot is connected to the network, including wire connection, and the quality of the network</p> <p>2. Check if the Setting\Network Setting is correct or not (if using Modbus TCP)</p> <p>3. Check if the settings on Modbus TCP Device is correct or not , including: ip address, port, address, signal type,</p>

etc.

4. Check if the settings on Modbus RTU Device is correct or not , including: ComPort, BaulRate, DataBits, StopBits, ParityCheck, address, signal type, etc.

[Solution]1. Confirm and restore the network, then enable Modbus again on Settings\Modbus

2. Confirm and correct the settings of Modbus Devices, then enable Modbus again on Settings\Modbus

1. Regularly check the quality of the network, including hardware.

2. It is suggested to have knowledge on Modbus before usage

ErrorSuggestion00048021 [Cause]System failed to write data through Modbus

[Caution]1. Check if the robot is connected to the network, including wire connection, and the quality of the network

2. Check if the Setting\Network Setting is correct or not (if using Modbus TCP)

3. Check if the settings on Modbus TCP Device is correct or not , including: ip address, port, address, signal type, etc.

4. Check if the settings on Modbus RTU Device is correct or not , including: ComPort, BaulRate, DataBits, StopBits, ParityCheck, address, signal type, etc.

[Solution]1. Confirm and restore the network, then enable Modbus again on Settings\Modbus

2. Confirm and correct the settings of Modbus Devices, then enable Modbus again on Settings\Modbus

1. Regularly check the quality of the network, including hardware.

2. It is suggested to have knowledge on Modbus before usage

ErrorSuggestion00048022 Please check parameter key is exist

ErrorSuggestion00048023 Please check parameter value is valid

ErrorSuggestion00048024 Please check file is exist

ErrorSuggestion00048025 Please check file size

ErrorSuggestion00048026 Please check file attribute is not read only

ErrorSuggestion00048027 Please check file does not exist

ErrorSuggestion00048028 Please check disk partition attribute information

ErrorSuggestion00048029 Please check disk partition attribute information

ErrorSuggestion0004802A Please check disk partition attribute information

ErrorSuggestion0004802B Please check array function datatype

ErrorSuggestion0004802C Please check array size

ErrorSuggestion0004802D Please check array function start index

ErrorSuggestion0004802E Please check Ethernet Slave is enabled

ErrorSuggestion0004802F Please check Ethernet Slave item name is valid

ErrorSuggestion00048030	Please check Ethernet Slave item value is valid
ErrorSuggestion00048601	<p>[Cause]HMI detected that one or more Warning situations during the project running.</p> <p>[Caution]The value of n in the string "Warning Counter(n)" showing in the HMI log displays that how many warning situations have during the project running.</p> <p>[Additional Explanation] Some warning information usually appears as a popped up message during flow editing, but the HMI could endure these warnings.</p> <p>If ignore it, the HMI log still shows these warnings to user during running the project.</p> <p>These warnings may be the following below:</p> <p>(1) Warning for String Format</p> <p>(2) Warning for Number Value maybe missing</p> <p>(3) ..etc.</p> <p>[Solution]To restore the robot from Warning Status :</p> <p>(in flow editing)</p> <p>Click on the OK button on the pop up windows.</p> <p>(in project running)</p> <p>Stop the running project through pressing the Stop button on Stick</p> <p>3. Check these warnings one by one and clear them.</p> <p>Check if data type mismatch of assignment variables in the flow.</p>
ErrorSuggestion00048602	<p>[Cause]System detected the text characters that may be strings but are without double quotes</p> <p>[Caution]1. Check if there are any strings used in the expression editor that have no double quotes</p> <p>2. Check to see if any variables used in the expression editor have been deleted from the Variable Manager</p> <p>[Additional Explanation] This error usually appears as a popped up message in HMI</p> <p>[Solution]Confirm that there are double quotes around all strings and that all variables used in the expression editor exist</p> <p>1. Make sure to use double quotes when defining strings</p> <p>2. Avoid deleting variables that are still in use</p>
ErrorSuggestion00048603	<p>[Cause]The operand in the assignment expression is assigned with a different type number.</p> <p>[Caution]Check if the operand in the left side of the assignment operator (" = ") is type matching with the right side one in the current project node (SET)</p> <p>[Precaution] This error would show on the pop up windows, not in the HMI log.</p> <p>[Additional Explanation]</p> <p>Number related expression should have the following instruction when using different types, i.e. :</p> <p>Correct :</p> <p>1. double = int,</p> <p>2. float = int</p> <p>3. double = float</p>

Incorrect :

1. int = double
2. int = float
3. float = double

[Solution]To restore the robot from Error Status :

Click on the OK button on the pop up windows then assign the same type number value or variable to the operands in the expression.

Makes sure all assignment expressions have the valid type-matching number operands.

ErrorSuggestion00048604

[Cause]A string type variable with single quotation marks(' ')

[Caution]Check if there is any single quotation marks is used in the issued expression

[Additional Explanation] This error usually appears as a popped up message in HMI

[Additional Explanation] This error usually happens in a SET Node, a variable with single quotation marks (i.e. String s1 = 'var_s2')

If ignore the warning message window, and running the project, this error code will show in the HMI log with the warning message 「Warning for String Format」

[Solution]To restore the robot from error status:

Flow editing

- 1.Click OK on the popped up windows
2. Delete the single quotation marks, or ignore it

Project running

- 1.Click the stop button on the stick
2. Delete the single quotation marks in a SET node, or ignore it

When editing in flow or before project running, make sure why to use a variable with the single quotation marks.

ErrorSuggestion00048605

[Cause]Network address is not available on Log node

[Caution]1. Check the network setting on Log node if the address is accessible

2. Check if the network target requires any advanced authority
3. Check if there is any other issue on the network, such as loosen Ethernet cable

[Additional Explanation]

This error usually appears in

1. Log node in project flow
2. The local network path format (i.e. \\192.168.1.1\sharedfolder)

This error would be triggered when system fails to connect to the network path

[Solution]To restore the robot from error status:

1. Press the STOP button on the robot stick, or

	2. Press the FREE button
	3. Make sure the network path could be access
	Make sure the network is accessible
ErrorSuggestion00048A00	Please wait some time, and retry to play project
ErrorSuggestion0004F000	General information
ErrorSuggestion00050000	No Error
ErrorSuggestion0005FF20	Please call own maintenance department and check items 1 & 2. If haven't, execute the third item.
	1. Check the conection status of solenoid.
	2. Check the surface of solenoid is abnormal , and the insulation plastic deformation
	3. Please contact the original purchase of a manufacturer or a third party designated maintenance unit.
ErrorSuggestion0005FF21	1. Please restart the robot.
	2. If the restart is invalid, please contact the original purchase or third-party designated maintenance units.
ErrorSuggestion0005FFA0	Please call own maintenance department and check items 1 & 2. If haven't, execute the third item.
	1. Check the power line of joint modules are loose or not.
	2. Check static/dynamic power supply is stable or not
	3. Please contact the original purchase of a manufacturer or a third party designated maintenance unit.
ErrorSuggestion0005FFA1	Please call own maintenance department and check items 1. If haven't, execute the second item.
	1. Check the Power Eater modules is normal or not.
	2. Please contact the original purchase of a manufacturer or a third party designated maintenance unit.
ErrorSuggestion0005FFA2	Be careful! G sensor overload on X direction.
ErrorSuggestion0005FFA3	Be careful! G sensor overload on Y direction.
ErrorSuggestion0005FFA4	Be careful! G sensor overload on Z direction.
ErrorSuggestion0005FFA5	1. Make sure environment temperature is lower than 40 degrees Celsius.
	2. Please check environment temperature is lower than 40 degrees Celsius while robot moving.
	3. Please contact the original purchase of the manufacturer or a third party designated maintenance unit.
ErrorSuggestion0005FFA6	1. Please slow down then check whether error is triggered again or not.
	2. Please check whether there is any collision while robot moving.
	3. Please contact the original purchase of the manufacturer or a third party designated maintenance unit.
ErrorSuggestion0005FFA7	1. Please slow down then check whether error is triggered again or not.
	2. Please check whether there is any collision while robot moving.
	3. Please contact the original purchase of the manufacturer or a third party designated maintenance unit.
ErrorSuggestion0005FFA8	1. Please slow down then check whether error is triggered again or not.
	2. Please check whether there is any collision while robot moving.
	3. Please contact the original purchase of the manufacturer or a third party designated maintenance unit.
ErrorSuggestion0005FFA9	Be careful! Motor current protection on U phase trigged, which may be caused by impact.
ErrorSuggestion0005FFAA	Be careful! Motor current protection on V phase trigged, which may be caused by impact.

ErrorSuggestion0005FFAB	<ol style="list-style-type: none"> 1. Please slow down then check whether error is triggered again or not. 2. Please check whether there is any collision while robot moving. 3. Please contact the original purchase of the manufacturer or a third party designated maintenance unit.
ErrorSuggestion0005FFAC	An error occurred in the UVW signal on optical encoder
ErrorSuggestion0005FFAD	The index of encoder is not calibrated.
ErrorSuggestion0005FFAE	<ol style="list-style-type: none"> 1. Please restart and check again. 2. Please slow down then check whether error is triggered again or not. 3. Please check whether there is any collision while robot moving. 4. Please contact the original purchase of the manufacturer or a third party designated maintenance unit.
ErrorSuggestion0005FFAF	<ol style="list-style-type: none"> 1. Please restart and check again. 2. Please slow down then check whether error is triggered again or not. 3. Please check whether there is any collision while robot moving. 4. Please contact the original purchase of the manufacturer or a third party designated maintenance unit.
ErrorSuggestion0005FFB1	<ol style="list-style-type: none"> 1. Please restart and check again. 2. Please slow down then check whether error is triggered again or not. 3. Please check whether there is any collision while robot moving. 4. Please contact the original purchase of the manufacturer or a third party designated maintenance unit.
ErrorSuggestion0005FFB2	<ol style="list-style-type: none"> 1. Please check grounding line is normal or not. 2. Please contact the original purchase of the manufacturer or a third party designated maintenance unit.
ErrorSuggestion0005FFB3	Please contact the original purchase of the manufacturer or a third party designated maintenance unit.
ErrorSuggestion0005FFB4	<ol style="list-style-type: none"> 1. Please try to restart the robot. 2. If the restart is invalid, please contact the original purchase or third-party designated maintenance units.
ErrorSuggestion0005FFB5	<ol style="list-style-type: none"> 1. Please try to restart the robot. 2. If the restart is invalid, please contact the original purchase or third-party designated maintenance units.
ErrorSuggestion0005FFB6	Please contact the original purchase of the manufacturer or a third party designated maintenance unit.
ErrorSuggestion0005FFB7	Please check the functionality of break unit
ErrorSuggestion0005FFB8	<ol style="list-style-type: none"> 1. Please restart and check again. 2. Please contact the original purchase of the manufacturer or a third party designated maintenance unit.
ErrorSuggestion0005FFB9	<ol style="list-style-type: none"> 1. Please restart and check again. 2. Please contact the original purchase of the manufacturer or a third party designated maintenance unit.
ErrorSuggestion0005FFBA	<ol style="list-style-type: none"> 1. Please restart and check again. 2. Please contact the original purchase of the manufacturer or a third party designated maintenance unit.
ErrorSuggestion0005FFC0	An error occurred in transit to absolute position
ErrorSuggestion0005FFC1	Please contact the original purchase of the manufacturer or a third party designated maintenance unit.
ErrorSuggestion0005FFC2	Please contact the original purchase of the manufacturer or a third party designated maintenance unit.
ErrorSuggestion0005FFC3	Please contact the original purchase of the manufacturer or a third party designated maintenance unit.

ErrorSuggestion0005FFC4	Please contact the original purchase of the manufacturer or a third party designated maintenance unit.
ErrorSuggestion0005FFC5	Please contact the original purchase of the manufacturer or a third party designated maintenance unit.
ErrorSuggestion0005FFC6	Please contact the original purchase of the manufacturer or a third party designated maintenance unit.
ErrorSuggestion0005FFC7	Please contact the original purchase of the manufacturer or a third party designated maintenance unit.
ErrorSuggestion0005FFC8	Please contact the original purchase of the manufacturer or a third party designated maintenance unit.
ErrorSuggestion0005FFC9	Please contact the original purchase of the manufacturer or a third party designated maintenance unit.
ErrorSuggestion0005FFCA	Please contact the original purchase of the manufacturer or a third party designated maintenance unit.
ErrorSuggestion0005FFCB	Please reduce the motion speed, check the flow and the speed and posture in each node
ErrorSuggestion0005FFCC	Please contact the original purchase of the manufacturer or a third party designated maintenance unit.
ErrorSuggestion0005FFCD	Please contact the original purchase of the manufacturer or a third party designated maintenance unit.
ErrorSuggestion0005FFCE	Please contact the original purchase of the manufacturer or a third party designated maintenance unit.
ErrorSuggestion0005FFCF	<ol style="list-style-type: none"> 1. Please check whether output torque is too large. Slow down if it is. 2. Please check whether there is any collision while robot moving. 3. Please contact the original purchase of the manufacturer or a third party designated maintenance unit.
ErrorSuggestion0005FFD0	Please check the UVW signal on encoder
ErrorSuggestion0005FFD1	Please contact the original purchase of the manufacturer or a third party designated maintenance unit.
ErrorSuggestion0005FFD2	Please contact the original purchase of the manufacturer or a third party designated maintenance unit.
ErrorSuggestion0005FFD3	<p>The robot may be disassembled abnormally. Please check the warranty sticker and thread-locking fluid are both broken or not.</p> <p>Please contact the original purchase of the manufacturer or a third party designated maintenance unit.</p>
ErrorSuggestion0005FFD4	Please contact the original purchase of the manufacturer or a third party designated maintenance unit.
ErrorSuggestion0005FFD5	Please contact the original purchase of the manufacturer or a third party designated maintenance unit.
ErrorSuggestion0005FFD6	Please contact the original purchase of the manufacturer or a third party designated maintenance unit.
ErrorSuggestion0005FFD7	Please contact the original purchase of the manufacturer or a third party designated maintenance unit.
ErrorSuggestion0005FFD8	Please contact the original purchase of the manufacturer or a third party designated maintenance unit.
ErrorSuggestion0005FFD9	<ol style="list-style-type: none"> 1. The robot may be disassembled abnormally. Please check the warranty sticker and thread-locking fluid are both broken or not. 2. The order of motor line, UVW, are abnormal. Please take the cover apart and make sure the order is correct. 3. Please contact the original purchase of a manufacturer or a third party designated maintenance unit.
ErrorSuggestion0005FFDA	Please contact the original purchase of the manufacturer or a third party designated maintenance unit.
ErrorSuggestion0005FFDB	Please contact the original purchase of the manufacturer or a third party designated maintenance unit.
ErrorSuggestion0005FFDC	Please contact the original purchase of the manufacturer or a third party designated maintenance unit.
ErrorSuggestion0005FFDD	<ol style="list-style-type: none"> 1. Please restart the robot. 2. If the restart is invalid, please contact the original purchase or third-party designated maintenance units.
ErrorSuggestion0005FFDE	<ol style="list-style-type: none"> 1. Please restart the robot. 2. If the restart is invalid, please contact the original purchase or third-party designated maintenance units.

ErrorSuggestion0005FFDF	1. Please restart the robot. 2. If the restart is invalid, please contact the original purchase or third-party designated maintenance units.
ErrorSuggestion0005FFE0	Please contact the original purchase of the manufacturer or a third party designated maintenance unit.
ErrorSuggestion0005FFE1	Please contact the original purchase of the manufacturer or a third party designated maintenance unit.
ErrorSuggestion0005FFE2	1. Please restart the robot. 2. If the restart is invalid, please contact the original purchase or third-party designated maintenance units.
ErrorSuggestion0005FFE3	1. Please restart the robot. 2. If the restart is invalid, please contact the original purchase or third-party designated maintenance units.
ErrorSuggestion0005FFE4	1. Please restart the robot. 2. If the restart is invalid, please contact the original purchase or third-party designated maintenance units.
ErrorSuggestion0005FFE5	1. Please restart the robot. 2. If the restart is invalid, please contact the original purchase or third-party designated maintenance units.
ErrorSuggestion0005FFE6	1. Please restart the robot. 2. If the restart is invalid, please contact the original purchase or third-party designated maintenance units.
ErrorSuggestion0005FFE7	Please contact the original purchase of the manufacturer or a third party designated maintenance unit.
ErrorSuggestion0005FFE8	Please contact the original purchase of the manufacturer or a third party designated maintenance unit.
ErrorSuggestion0005FFE9	Please contact the original purchase of the manufacturer or a third party designated maintenance unit.
ErrorSuggestion0005FFEA	Please contact the original purchase of the manufacturer or a third party designated maintenance unit.
ErrorSuggestion0005FFEB	Please contact the original purchase of the manufacturer or a third party designated maintenance unit.
ErrorSuggestion0005FFEC	Please contact the original purchase of the manufacturer or a third party designated maintenance unit.
ErrorSuggestion0005FFED	Please contact the original purchase of the manufacturer or a third party designated maintenance unit.
ErrorSuggestion0005FFEE	Please turn on joint modules
ErrorSuggestion0005FFEF	Please contact the original purchase of the manufacturer or a third party designated maintenance unit.

OMRON Corporation Industrial Automation Company

Kyoto, JAPAN

Contact: www.ia.omron.com

Regional Headquarters

OMRON EUROPE B.V.

Wegalaan 67-69, 2132 JD Hoofddorp
The Netherlands
Tel: (31)2356-81-300/Fax: (31)2356-81-388

OMRON ASIA PACIFIC PTE. LTD.

No. 438A Alexandra Road # 05-05/08 (Lobby 2),
Alexandra Technopark,
Singapore 119967
Tel: (65) 6835-3011/Fax: (65) 6835-2711

OMRON ELECTRONICS LLC

2895 Greenspoint Parkway, Suite 200 Hoffman Estates,
IL 60169 U.S.A.
Tel: (1) 847-843-7900/Fax: (1) 847-843-7787

OMRON ROBOTICS AND SAFETY TECHNOLOGIES, INC.

4225 Hacienda Drive, Pleasanton CA 94588 U.S.A.
Tel: (1) 925-245-3400/Fax: (1) 925-960-0590

OMRON (CHINA) CO., LTD.

Room 2211, Bank of China Tower, 200 Yin Cheng Zhong Road,
PuDong New Area, Shanghai, 200120, China
Tel: (86) 21-5037-2222/Fax: (86) 21-5037-2200

Authorized Distributor:

© Techman Robot Inc. 2018-2020 All Rights Reserved
In the interest of product improvement,
specifications are subject to change without notice.

Cat. No. I626-E-07

0820